

3-cobordisms with their rational homology on the boundary^{*†‡}

Dorin Cheptea and Thang T Q Le

Abstract

The object of this paper is to define a subcategory of the category of 3-cobordisms to which invariants of rational homology 3-spheres should generalize. We specify the notion of Topological Quantum Field Theory (in the sense of Atiyah [1]) to this case, and prove two interesting properties that these TQFTs always have. In the case of the LMO invariant these properties amount to saying that the TQFT is anomaly-free.

This paper is organized as follows. In Section 1 we define the topological categories of 3-cobordisms \mathfrak{Q} , \mathfrak{J} , and \mathfrak{L} that we want to consider, where the morphisms are certain *connected* oriented 3-cobordisms (with parametrizations of the boundary components). Their domain and range are also *connected* oriented closed surfaces. All the proofs in this section are elementary when given rigorous definition.¹ In Section 2 we give the axioms of TQFT for these categories, and prove two interesting properties.

There are two essential differences between this type of TQFTs and the classical TQFTs, such as Reshetikhin-Turaev's for quantum invariants. Firstly, we tailor the construction for integer and rational homology spheres. Therefore we restrict to *connected* cobordisms between *connected* surfaces, and hence have no tensor product \otimes structure induced by disjoint union. Secondly, when gluing, we discriminate between the domain and the range of a cobordism. In particular, while we regard the standard surface Σ_g of genus g in the domain as the boundary of the standard handlebody N_g , we regard Σ_g in the range as the boundary of the complement of N_g in S^3 . Thus, gluing identically in our TQFT produces S^3 as opposed to $\#_g(S^2 \times S^1)$ in the Reshetikhin-Turaev TQFT. This framework still allows to derive associated representations of the Torelli group, in fact of a larger *Lagrangian subgroup* of the Mapping Class Group.

These definitions and properties are motivated by the construction of a TQFT for the Le-Murakami-Ohtsuki invariant Z^{LMO} [3,14], because this invariant is strong for rational homology three-spheres, and is weaker if the rank of homology is bigger. However the two simple properties that we prove in section 2 can be useful for any TQFT on \mathfrak{Q} .

1 The categories $\mathfrak{Q} \supset \mathfrak{J} \supset \mathfrak{L}$ of semi-Lagrangian cobordisms

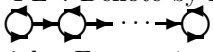
All maps and homeomorphisms in this paper are piecewise-linear, hence we will generally drop the term "PL". Denote by Γ^g and call *chain graph* (terminology borrowed from [14]) the abstract trivalent graph  with oriented edges as indicated. Label its subgraphs \mathfrak{Q} from 1 to g from left to right. For $g = 1$, set $\Gamma^1 = \mathfrak{Q}$, one oriented edge, no vertices. For $g = 0$, set $\Gamma^0 =$ one point.

Definition 1) A pair (Γ, R) , consisting of an ordered disjoint union of chain graphs and an oriented surface with boundary, will be called a **ribbon pair** if it is the union of finitely many copies of the two pairs depicted in the figure 1a, such that each point of Γ has a neighbourhood PL-homeomorphic to one

^{*}2000 Mathematics Subject Classification: 57M27.

[†]Key words: homology spheres, cobordisms, knots, LMO invariant, TQFT, Mapping Class Group, Torelli group

[‡]The results of this article were obtained when the authors were at the Department of Mathematics, State University of New York at Buffalo, Buffalo, NY 14260-2900, USA

¹Perhaps we should remove the proofs of Propositions 1 through 7 altogether.

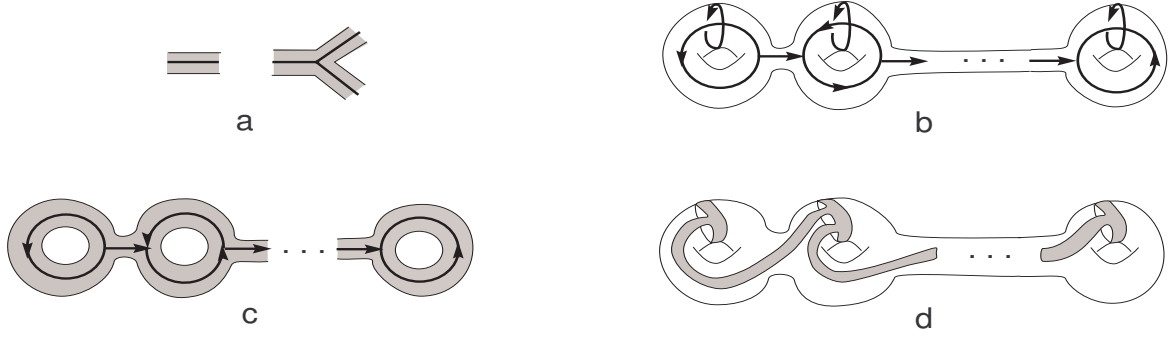

Figure 1: **a**: Local pieces that compose a ribbon pair, **b**: The standard b -graph, loops a_i, b_i on Σ_g , **c**: $\Gamma^g \subset S^3$ and its preferred ribbon graph neighbourhood R^g , **d**: $\overline{R^g_{push}} \subset \Sigma^g$, whose core (not drawn here) is the standard a -graph.

of the two depicted pairs; the first set in any pair is always a subset of the second; the union of the first sets is Γ ; and the union of the second sets is R . For $\Gamma = \Gamma^0$ we require R to be homeomorphic to D^2 and the point Γ^0 be the center of the disk.

2) A surface R embedded in M , together with a subset $\Gamma \subset R$, such that (Γ, R) is a ribbon pair, and such that at any trivalent vertex, viewed as a point in M , the three tangent vectors to Γ coming from the three edges span a 2-plane, shall be called a **ribbon graph neighbourhood** of $\Gamma \subset M$, and $G = (\Gamma, R)$ will be called an **embedded FRAMED graph**.

3) Two **triplets** (K, G_1, G_2) and (L, H_1, H_2) , consisting each of a framed oriented link K (respectively L) in S^3 , and two disjoint (and disjoint from the corresponding link) embedded FRAMED graphs are **equivalent** (notation \cong) if there is a PL-homeomorphism $\phi: S^3 \rightarrow S^3$ which preserves the link and the embedded framed graphs, i.e. ϕ sends K to L , the first embedded framed graph $G_1 = (\Gamma_1, R_1)$ to the first embedded framed graph $H_1 = (\Delta_1, S_1)$, and the second $G_2 = (\Gamma_2, R_2)$ to the second one $H_2 = (\Delta_2, S_2)$. Here \emptyset is also considered a framed oriented link in S^3 . Call $G_1 = (\Gamma_1, R_1)$ the **bottom**, and $G_2 = (\Gamma_2, R_2)$ the **top** of the triplet.

Fix N_g – a standard neighbourhood of Γ^g in S^3 . $\Sigma_g = \partial N_g \subset S^3$ will be called the *standard oriented surface of genus g* . Let \overline{N}_g be the handlebody complement of N_g in S^3 . We also denote by $\overline{\Gamma}^g$ the core of \overline{N}_g . Clearly $\partial \overline{N}_g = -\Sigma_g$. When $g = 0$, i.e. if Γ^g is a point, N_g is a ball. Call N_g the *standard handlebody*, and \overline{N}_g the *standard anti-handlebody of genus g* .

Fix the g pairs of standard loops $a_i, b_i, i = 1, \dots, g$ on Σ_g as in figure 1b. Namely, a_i 's bound disks in N_g , the bounded component of $\mathbb{R}^3 - \Sigma_g$, while b_i 's bound disks in \overline{N}_g . The embedded standard graph Γ^g in $\mathbb{R}^3 \subset S^3$ has a preferred (the blackboard) ribbon graph neighbourhood R^g (with $\partial R^g \subset \Sigma_g$). Hence we can construct its *push* along the framing transversal to the ribbon, a graph $\Gamma^g_{push} \subset \Sigma_g$ (together with a ribbon graph neighbourhood $R^g_{push} \subset \Sigma_g$). Namely, the oriented circle components of this graph coincide with the loops b_i . Call Γ^g_{push} the *standard b -graph*. Similarly, the circle components of $\overline{\Gamma}^g_{push}$ are the loops a_i . For "up-to-isotopy" pictures see figure 1.

Σ or Σ_i will generically denote a standard Σ_g , or a disjoint union of these. For an oriented connected closed surface S , a *parametrization* of S is an orientation-preserving homeomorphism between a standard Σ and S .

Definition Let M be a compact oriented 3-manifold with boundary $\partial M = (-S_1) \cup S_2$, suppose also that parametrizations f_1, f_2 of each S_1, S_2 are fixed. We will call such (M, f_1, f_2) a (parametrized) **(2+1)-cobordism**. S_1 will be called the **bottom**, S_2 – the **top** of the cobordism. The cobordisms (M, f_1, f_2) and (N, h_1, h_2) will be called **equivalent (homeomorphic)** if there is a PL-homeomorphism $F: M \rightarrow N$ sending bottom to bottom and top to top preserving the parametrizations, i.e. $F \circ f_i = h_i, i = 1, 2$. We will use \cong to denote equivalent cobordisms.

Using the parametrizations, we can glue the standard handlebody N_{g_1} to the bottom and the standard

anti-handlebody $\overline{N_{g_2}}$ to the top of M . Denote the result $M \cup_{f_1} N_{g_1} \cup_{-f_2} (-\overline{N_{g_2}})$ by \widehat{M} and call it *the filling* of (M, f_1, f_2) .

1.1 Surgery description of gluing cobordisms

Let \mathfrak{G} denote set of equivalence classes of triplets (L, G_1, G_2) in S^3 . Let \mathfrak{C} denote the set of equivalence classes of 3-cobordisms, with non-empty bottom and top.

Proposition 1. 1) *There is a natural well-defined map $\kappa : \mathfrak{G} \rightarrow \mathfrak{C}$ that associates to every equivalence class of triplets (L, G_1, G_2) the equivalence class of cobordisms (M, f_1, f_2) , obtained by doing surgery on $L \subset S^3$, removing tubular neighbourhoods N_1, N_2 of each G_1, G_2 , and recording the parametrizations of the two obtained boundary components. If one glues according to these parametrizations a standard handlebody to $-\partial N_1$ and a standard anti-handlebody to ∂N_2 , then one obtains S_L^3 .*

2) κ is surjective, and hence there exist maps $\nu : \mathfrak{C} \rightarrow \mathfrak{G}$ such that on 3-cobordisms with two non-empty boundary components $\kappa \circ \nu = id$.

3) Let a **first Kirby move** on a triplet be the cancellation / insertion of a $\mathbf{O}^{\pm 1}$ separated by an S^2 from anything else, and an **extended (generalized) second Kirby move** be a slide over a link component of an arc, either from another link component or from a chain graph. Then if one factors \mathfrak{G} by the extended Kirby moves and changes of orientations of link components, the induced map $\bar{\kappa}$ is a bijection.

Proof. 1) The parametrizations are determined as follows. For $i = 1, 2$, let N_i be the closure of a tubular neighbourhood of G_i such that $\partial R_i \subset \partial N_i$. (Since R_i is compact, there is a neighbourhood of G_i of the form $R_i \times [-\varepsilon, \varepsilon]$. Take this as N_i .) Let $M = \overline{S_L^3 - (N_1 \cup N_2)}$, $S_1 = \partial N_1$, $S_2 = -\partial N_2$. In particular, this construction yields $S_i \approx S^2$ if $G_i \approx \Gamma^0$. In the last case the possible parametrization is unique up to isotopy.

Fix a preferred point x on each (open) upper half-circle of each Γ^g . This determines a preferred point x' on each circle component of G_1 . The construction of N_1 produces a preferred disk in N_1 , centered at x' , with boundary in ∂N_1 . Orient the boundary curves so that they twist right-handedly with respect to the circle components of G_1 . Similarly, fix a preferred point y on each (open) lower half-circle of each Γ^g and construct an ordered system b of oriented curves for the handlebody N_2 . (We assume N_2 contains the point at infinity $\infty \in S^3$, hence we will refer to N_2 as the *anti-handlebody*.) Push G_1 along a framing transversal to R_1 to a graph on S_1 , call it *the b-graph*. Analogously, push G_2 along a framing transversal R_2 to a graph on S_2 , call it *the a-graph*.

If we cut-open S_1 along the b-graph and the system a , we get an oriented surface homeomorphic to D^2 . Define the parametrization of S_1 by sending the standard b-graph on Σ_{g_1} to the b-graph on S_1 , and the system of loops a_i on Σ_{g_1} to the system a . Similarly for S_2 : both $\Sigma - (\{\text{standard } a\text{-graph}\} \cup \{\text{standard system } b\})$ and $S_2 - (\{a\text{-graph}\} \cup \{\text{system } b\})$ are homeomorphic as oriented surfaces to the oriented D^2 . Any two orientation-preserving homeomorphisms of D^2 are isotopic. Therefore the parametrization of S_i is uniquely determined up to isotopy by $G_i = (\Gamma_i, R_i)$. (Observe that different choices of transversal framings to the ribbons lead to isotopic b-graphs / a-graphs on S_i ; different choices of the points x lead to isotopic systems a / b .)

In conclusion, κ of each triplet is well-defined as an equivalence class of 3-cobordisms. It is obvious that via the above construction equivalent triplets yield the same equivalence class of 3-cobordisms.

Moreover, in the above construction of parametrizations, the homeomorphism between the standard surface Σ and S extends to a homeomorphism between the standard handlebody / anti-handlebody and N_i . Hence $\widehat{M} \approx S_L^3$.

2) Let \widehat{M} be the filling of a 3-cobordism (M, f_1, f_2) , Γ_1, Γ_2 - the images in \widehat{M} of the cores and R_1, R_2 - the images in \widehat{M} of the preferred ribbon graph neighbourhoods of the cores of the handlebody, respectively anti-handlebody of \widehat{M} . Since \widehat{M} is a closed 3-manifold, there is a banded (unoriented) link $L \subset S^3$, such that $\widehat{M} \approx S_L^3$, the result of surgery on L . Choose one such link L . Then there exist two disjoint framed graphs G_i , $i = 1, 2$ in S^3 , also disjoint from the link L , such that their remains after

surgery coincide (up to ambient isotopy) with the pairs (Γ_i, R_i) , $i = 1, 2$ in \widehat{M} .²
 3) see [14, proposition 2.1] □

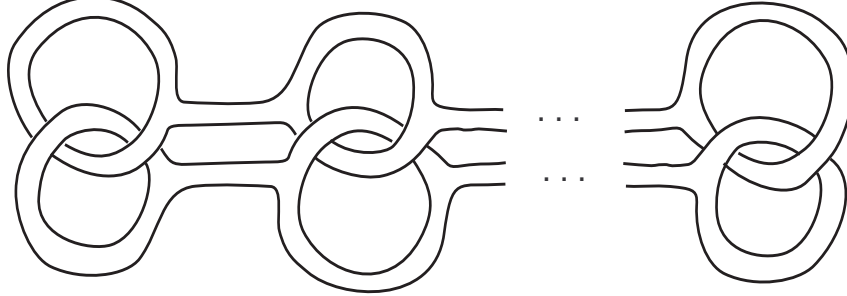

Figure 2: *The preferred choice of ribbons R_i , $i = 1, 2$ for $(\Sigma_g \times I, p_1, p_2)$.*

To visualize the above proof it is helpful to imagine the standard b-graph and system a (and respectively the standard a-graph and system b) cutting Σ_g to a 2-disk. Strictly speaking the definitions of the b-graph and system a make sense if both $g_1, g_2 > 0$. However we can add the remaining cases by making the following convention: if Γ_i is a point, the b-graph/a-graph and the system a/b are to be considered the empty set. To draw a framed graph $G_i = (\Gamma_i, R_i) \subset S^3$, we only need to draw the projection of Γ_i on \mathbb{R}^2 , which can be done in such a way that the preferred blackboard framing determines R_i up to isotopy.

Let us consider $\Sigma_g \times I \subset S^3$. $\Sigma_g \times \{0\}$ and $\Sigma_g \times \{1\}$ are identified with two very near (isotopic) copies of the standard embedding $\Sigma_g \subset S^3$. $(\Sigma_g \times I, p_1, p_2)$ is a 3-cobordism, and its filling is homeomorphic to S^3 . The parametrizations of the bottom p_1 and top p_2 are the ones induced via the isotopies in S^3 between the standard Σ_g and $\Sigma_g \times \{i\}$ from the identity $id : \Sigma_g \rightarrow \Sigma_g \subset S^3$. To represent this 3-cobordism we choose framed graphs R_1, R_2 as depicted in figure 2 (projections on $\mathbb{R}^2 \subset \mathbb{R}^3 \subset S^3$). Observe the consistency with Figure 1d. Denote by $[D_g]_{L_0}$ the result of surgery on the link L_0 in D_g , the three-dimensional manifold depicted in figure 3. Note the disks E_k and E'_k in D_g , that intersect L_0 once. If $g = 0$, set $D_g \approx S^2 \times I$ and $L_0 = \emptyset$. $([D_g]_{L_0}, p_1, p_2)$ is a 3-cobordism equivalent to $(\Sigma_g \times I, p_1, p_2)$.

Proposition 2 *Let (M, f_1, f_2) and (N, h_1, h_2) be arbitrary 3-cobordisms with connected bottoms and tops. The following 3-cobordisms are equivalent:*

$$(N \cup_{h_1 \circ f_2^{-1}} M, f_1, h_2) \cong (N \cup_{h_1 \circ p_2^{-1}} [D_g]_{L_0} \cup_{p_1 \circ f_2^{-1}} M, f_1, h_2) \quad (1.1)$$

Proof. Start with the right-hand-side. Using Kirby calculus, slide the handles of the surface S_1 along the upper components of the link L_0 . Then the lower components of L_0 bound disks, so the link can be canceled altogether. The two surfaces that remain are clearly isotopic, and the parametrizations are equivalent since both are images under isotopies of the identity parametrization of $\Sigma_g \subset S^3$. The equivalence thus follows. □

Let Γ , respectively Γ' generically denote the bottom, respectively the top of a triplet. Call the union of the lower half-circles and the horizontal segments of Γ , *the horizontal line* of Γ . Similarly, call the union of the upper half-circles and the horizontal segments of Γ' , *the horizontal line* of Γ' . See figure 4a.

For a given genus g , let us decompose the manifold D_g , together with the link L_0 inside, into a union of upper handles D^U , lower handles D^L , and the rest of it D^M : $D_g = D^U \cup D^M \cup D^L$. In figure 3 instead of the whole handles, we have represented only disks E_k and E'_k , whose neighbourhoods the handles are. Accordingly, $L_0 \subset D_g$ can be decomposed into three framed oriented tangles: an oriented framed tangle in the upper handles, the oriented tangle T_g with the blackboard framing (see figure 4b), and an oriented framed tangle in the lower handles. For $g = 0$, $T_0 = \emptyset$.

²Indeed, isotope the image of (Γ_i, R_i) via $\widehat{M} \xrightarrow{\cong} S_L^3$ to avoid the union of surgery tori, a bounded nonseparating subset of S_L^3 .

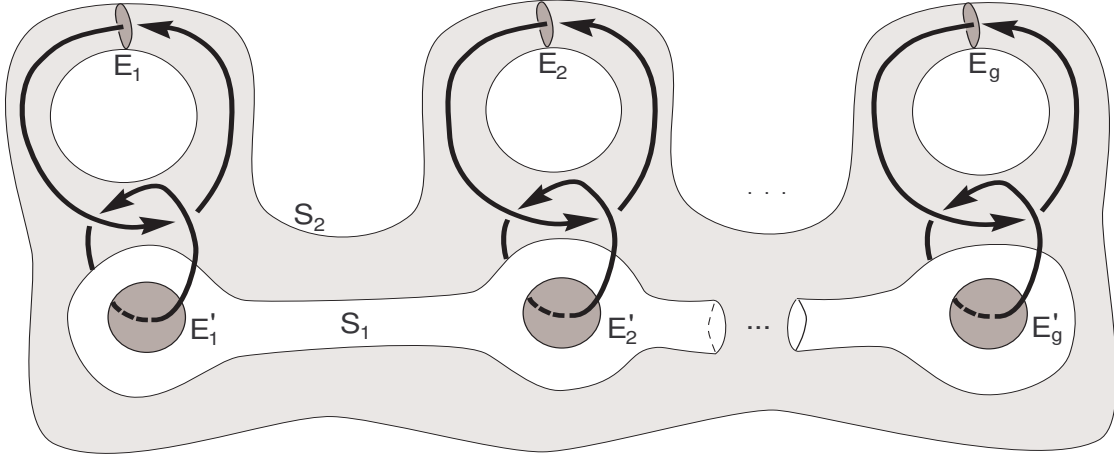

Figure 3: $L_0 \subset D_g$

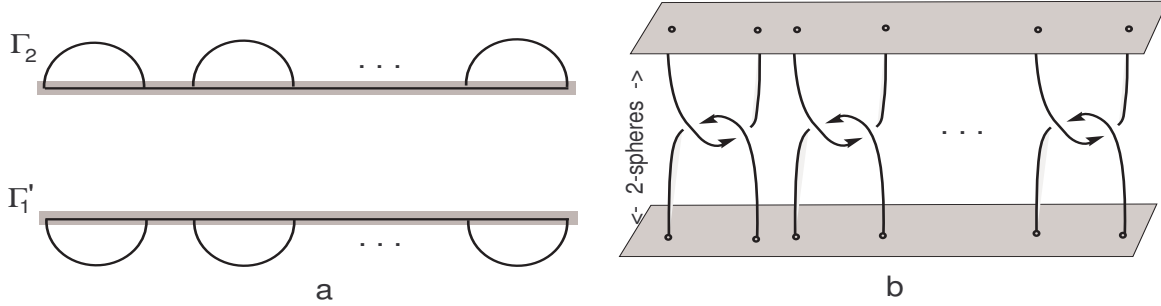

Figure 4: **a:** The horizontal segments of Γ'_1 and Γ_2 ; **b:** Framed tangle $T_g \subset \overline{B(0, 2) - B(0, 1)}$.

Proposition 3 Let (M_1, f_1, f'_1) and (M_2, f_2, f'_2) be two 3-cobordisms with connected non-empty bottoms and tops. Let $v(M_1, f_1, f'_1) = (L_1, G_1, G'_1)$, $v(M_2, f_2, f'_2) = (L_2, G_2, G'_2)$ where v is some section of κ . Remove a 3-ball neighbourhood of the horizontal line of $G'_1 \subset S^3$, and identify the remain with $\overline{B(0, 1)}$. Remove a 3-ball neighbourhood of the horizontal line of $G_2 \subset S^3$, and identify the remain with $S^3 - B(0, 2)$. Glue the framed tangle $T_g \subset \overline{B(0, 2) - B(0, 1)}$ shown in figure 4b to the ends of the remains of G'_1 in $\overline{B(0, 1)}$ and G_2 in $S^3 - B(0, 2)$, strictly preserving the order of the points, so that the composition of these framed tangles is a smooth framed oriented link L_0 in $S^3 = (\overline{S^3 - B(0, 2)}) \cup (\overline{B(0, 2) - B(0, 1)}) \cup \overline{B(0, 1)}$. Then

$$\kappa(L_1 \cup L_0 \cup L_2, G_1, G'_2) = (M_2 \cup_{f_2 \circ (f'_1)^{-1}} M_1, f_1, f'_2) \tag{1.2}$$

where the ribbon neighbourhoods R_1, R'_2 of G_1, G'_2 in this formula are determined by the original R_1, R'_2 in the two copies of S^3 . Hence, any triplet representing $(M_2 \cup_{f_2 \circ (f'_1)^{-1}} M_1, f_1, f'_2)$ is equivalent to $(L_1 \cup L_0 \cup L_2, G_1, G'_2)$ by extended (generalized) Kirby moves and changes of orientations of link components.

Proof. Let us first note that the result is obvious if the two cobordisms are glued along a 2-sphere. For the general case, first use proposition 1.3 to "insert" $[D_g]_{L_0}$ "between" the two cobordisms (for appropriate g). This changes $(M_2 \cup_{f_2 \circ (f'_1)^{-1}} M_1, f_1, f'_2)$ to an equivalent 3-cobordism.

Observe that gluing the standard handlebody N_g to D_g along p_1 produces a manifold homeomorphic to N_g . Moreover, gluing $D_g \cup_{p_1} N_g$ along $f_2 \circ p_2^{-1}$ to the bottom of the cobordism M_2 produces a manifold

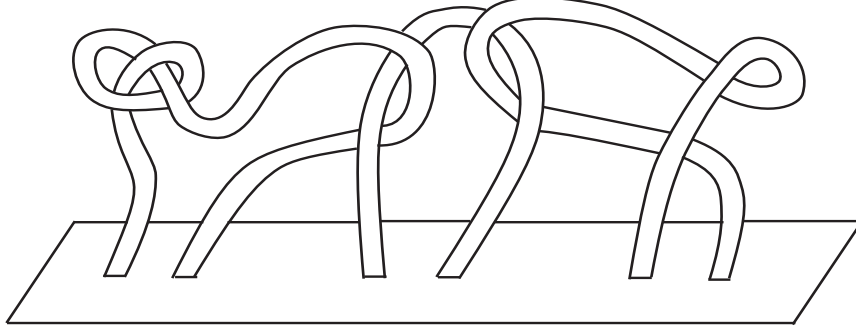

Figure 5: An example (only the ribbons are depicted) of gluing the upper handles of D_g .

homeomorphic to the one obtained by gluing N_g directly (along f_2). In fact this homeomorphism is identity outside a collar neighbourhood of the bottom of M_2 .

Now, using the decomposition $D_g = D^U \cup D^M \cup D^L$, we note that gluing $D_g \cup_{p_1} N_g$ to M_2 is the same as first gluing D^U on part of its boundary along the corresponding “restriction” of the map $f_2 \circ p_2^{-1}$, then gluing $(D^M \cup D^L) \cup_{p_1} N_g \approx D^3$ along a 2-sphere.

Let us look at this glued 3-ball in the presentation of the filling \widehat{M}_2 as $S_{L_2}^3$. By enlarging D^U and D^L if necessary, we may assume that inside this 3-ball there is only a neighbourhood of the horizontal line of Γ_2 with R_2 of blackboard framing.

Apply a similar procedure to the top of the 3-cobordism M_1 : we may thus assume that $M_1 \cup_{f_1 \circ p_1^{-1}} \overline{N_g}$ is equivalent (and the respective homeomorphism is identity except in a collar neighbourhood of the top of M_1) to a cobordism decomposed along a 2-sphere into $M_1 \cup_{\text{restriction of } f_1 \circ p_1^{-1}} D^L$ and $D^M \cup D^U \cup_{p_2^{-1}} \overline{N_g}$, the later homeomorphic to a 3-ball; and that the corresponding triplet in S^3 has inside that 3-ball only a neighbourhood of the horizontal line of Γ'_1 with R'_1 of blackboard framing.

Hence $(M_2 \cup_{f_2 \circ p_2^{-1}} [D_g]_{L_0} \cup_{p_1 \circ (f_1')^{-1}} M_1, f_1, f_2')$ can be decomposed into three pieces: $M_2 \cup_{\text{restriction of } f_2 \circ p_2^{-1}} D^U$, D^M , and $D^L \cup_{\text{restriction of } p_1 \circ (f_1')^{-1}} M_1$, that have to be glued along two 2-spheres. Observe that D^M with the remaining tangle inside it is homeomorphic with $\overline{B(0, 2) - B(0, 1)}$ with tangle T_g inside. Therefore (1.2), where all objects are as described in the statement, holds. \square

1.2 \mathbb{Q} - and \mathbb{Z} -cobordisms

For a chain graph Γ^g embedded in S^3 , denote μ_1, \dots, μ_g the meridians of the upper half-circles, defined by the right-hand rule, just as the meridians of oriented link components are defined.

Proposition 4 *Let Γ^g be embedded in an arbitrary way in S^3 , then $H_1(S^3 - \Gamma^g, \mathbb{Z}) \cong \mathbb{Z}^g$, with free generators μ_1, \dots, μ_g .*

Proof. Either write down the exact homology sequence of the pair $(S^3, S^3 - \Gamma^g)$ between $H_2(S^3, \mathbb{Z}) = 0$ and $H_1(S^3, \mathbb{Z}) = 0$; or use Alexander duality; or write down the Mayer-Vietoris sequence (for the reduced homology) of the decomposition $S^3 - \Gamma^g = A \cup B$, where A is the complement in D^3 of the graph:

$$\begin{pmatrix} & & Id_{2g-1} & & \\ 1 & -1 & 0 & 0 & \dots & 0 \\ 0 & 0 & 1 & -1 & \dots & 0 \\ \vdots & \vdots & \vdots & \vdots & \ddots & \vdots \\ 0 & 0 & 0 & 0 & \dots & 1 \end{pmatrix}$$

and B is some embedding of $\sqcup_g I$ in $S^3 - D^3$, to get $H_1(S^3 - \Gamma^g, \mathbb{Z})$ as a quotient of $H_1(A, \mathbb{Z}) \oplus H_1(B, \mathbb{Z}) \cong \mathbb{Z}^{2g-1} \oplus \mathbb{Z}^g$ through the image of $H_1(A \cap B, \mathbb{Z}) \cong \mathbb{Z}^{2g-1}$ via the map given by the matrix above. \square

This proposition admits an obvious generalization to the case of several connected components Γ^{g_j} . Loosely speaking, it says that homology does not detect the horizontal lines.

Proposition 5 *Suppose M is a connected compact oriented 3-manifolds with two distinguished (not necessarily connected) boundary components $\partial M = (-S_1) \cup S_2$, let f_1, f_2 be parametrizations of these surfaces, let N_1 and $\overline{N_2}$ be corresponding-to-the-genera disjoint unions of standard handlebodies, respectively anti-handlebodies, and let $i = (i_1, i_2) : \partial M \hookrightarrow M$ be the inclusion. The following conditions are equivalent:*

- (1) $H_1(\widehat{M}, \mathbb{Z}) = 0$
- (2) $H_1(M, \mathbb{Z}) = i_*(H_1(\partial M, \mathbb{Z}) / (f_1, -f_2)_* H_1(N_1 \sqcup -\overline{N_2}, \mathbb{Z}))$

They imply:

- (3) $2 \cdot \text{rank } H_1(M; \mathbb{Z}) = \text{rank } H_1(\partial M; \mathbb{Z})$

Proof. We will prove this proposition for $S_1 \approx \Sigma_{g_1}$ and $S_2 \approx \Sigma_{g_2}$, $g_1, g_2 \geq 0$. The general case is absolutely analogous.³

Applying Mayer-Vietoris to $\widehat{M} = (M \cup_{f_1} N_{g_1}) \cup_{-f_2} (-\overline{N_{g_2}})$, using the fact that $(M \cup_{f_1} N_{g_1}) \cap \overline{N_{g_2}} = \partial \overline{N_{g_2}}$ is connected, and then the second isomorphism theorem, we obtain $H_1(\widehat{M}, \mathbb{Z}) \cong \frac{H_1(M \cup_{f_1} N_{g_1}, \mathbb{Z}) \oplus H_1(\overline{N_{g_2}}, \mathbb{Z})}{i_{2*} H_1(S_2, \mathbb{Z})} \cong \frac{H_1(M \cup_{f_1} N_{g_1}, \mathbb{Z})}{i_{2*} H_1(S_2, \mathbb{Z}) / (i_{2 \circ (-f_2)})_* H_1(N_{g_2}, \mathbb{Z})}$. In a similar fashion $M \cap N_{g_1} = \partial N_{g_1}$ is connected, and $H_1(M \cup_{f_1} N_{g_1}, \mathbb{Z}) \cong \frac{H_1(M, \mathbb{Z})}{i_{1*} H_1(S_1, \mathbb{Z}) / (i_{1 \circ f_1})_* H_1(N_{g_1}, \mathbb{Z})}$. Therefore $H_1(\widehat{M}, \mathbb{Z}) \cong \frac{H_1(M, \mathbb{Z})}{i_{1*} (H_1(S_1, \mathbb{Z}) / f_{1*} H_1(N_{g_1}, \mathbb{Z})) + i_{2*} (H_1(S_2, \mathbb{Z}) / (-f_2)_* H_1(\overline{N_{g_2}}, \mathbb{Z}))}$, which proves (1) \iff (2).

(1) \implies (3) We will give a geometric proof, naturally extending linking relations from the case of closed 3-manifolds [7].

There is a link $L \subset S^3$ such that $\widehat{M} \approx S_L^3$. Moreover, this link can be taken disjoint from the embedding $\Gamma^{g_1} \sqcup \overline{\Gamma}^{g_2} \hookrightarrow S^3$, such that (identifying as before $\Gamma^{g_1} \sqcup \overline{\Gamma}^{g_2}$ with the remain after surgery on L) $\widehat{M} - N(\Gamma^{g_1} \sqcup \overline{\Gamma}^{g_2}) \approx M$ for a tubular neighbourhood $N(\Gamma^{g_1} \sqcup \overline{\Gamma}^{g_2})$. Hence, there is a neighbourhood $N(L \sqcup \Gamma^{g_1} \sqcup \overline{\Gamma}^{g_2})$ such that M is obtained from $S^3 - N(L \sqcup \Gamma^{g_1} \sqcup \overline{\Gamma}^{g_2})$ by adding a 2-handle and a 3-handle for each component L . By proposition 4 (and the remark afterwards) $H_1(S^3 - N(L \sqcup \Gamma^{g_1} \sqcup \overline{\Gamma}^{g_2}), \mathbb{Z}) \cong \mathbb{Z}^{|L|+g_1+g_2}$ with generators $\mu_1, \dots, \mu_{|L|+g_1+g_2}$, the right-handed oriented meridians of the link components K_j , the upper-half-circles U_j of Γ^{g_1} , and the lower half-circles V_j of $\overline{\Gamma}^{g_2}$. Therefore $H_1(M, \mathbb{Z})$ is a quotient of the former by $|L|$ relations, one for each 2-handle. If the component K_i of L has surgery coefficient (framing) l_i and the preferred longitude λ_i (i.e λ_i has framing 0 in S^3), then the corresponding relation is $l_i \mu_i + \lambda_i = 0$. But λ_i is the boundary of a Seifert surface F_i in S^3 , punctured by the other components K_j , $j \neq i$, U_j and V_j (clearly F_i can be taken disjoint from two 3-balls, hence the intersection with $\Gamma^{g_1} - U_j$ and $\Gamma^{g_1} - V_j$ can be avoided). These intersections result in a surface F_i' with additional boundary components homologous to $\pm \mu_j$. Therefore F_i' determines a relation $\lambda_i = \sum_{j \neq i} lk(K_j, K_i) \mu_j + \sum_j lk(U_j, K_i) \mu_{|L|+j} + \sum_j lk(V_j, K_i) \mu_{|L|+g_1+j}$ for the homology of M .

Hence $H_1(M, \mathbb{Z})$ is a quotient of $\mathbb{Z}^{|L|+g_1+g_2}$ through the image of $A : \mathbb{Z}^{|L|} \rightarrow \mathbb{Z}^{|L|+g_1+g_2}$ given by the $(|L| + g_1 + g_2) \times |L|$ -matrix $\begin{pmatrix} lk_{ij} \\ \mathbf{lk}_{\Gamma L} \end{pmatrix}$. (Here $lk_{ii} = l_i$.)

On the other side, adding a 2-handle (along the corresponding μ_j) for each component U_j and V_j , as well as a 3-handle for Γ^{g_1} and 3-handle for $\overline{\Gamma}^{g_2}$, one obtains \widehat{M} . At the level of homology this adds precisely the relations $\mu_j = 0$ for $j = |L| + 1, \dots, |L| + g_1 + g_2$. This means that $H_1(\widehat{M}, \mathbb{Z})$ is a quotient of $\mathbb{Z}^{|L|}$ through the image of the linear homomorphism B given in the μ -basis by the $|L| \times |L|$ -matrix (lk_{ij}) , the linking matrix of L . Since $H_1(\widehat{M}, \mathbb{Z}) = 0$, (lk_{ij}) is unimodular, hence invertible (over \mathbb{Z}). Therefore there is a basis $(\nu_1, \dots, \nu_{|L|})$ of the module freely generated by $\mu_1, \dots, \mu_{|L|}$, such that the matrix

representing B in the new basis has the form $\begin{pmatrix} \pm 1 & & \mathbf{0} \\ & \ddots & \\ \mathbf{0} & & \pm 1 \end{pmatrix}$. Correspondingly $A = B \oplus \mathbf{lk}_{\Gamma L}$ has in

³The case when $S_j = \emptyset$ follows readily from the case $S_j \approx S^2$. Our convention then is that $\emptyset_* = 0$, where \emptyset is the topological map and 0 is the algebraic one. Then $Im(i_j \circ f_j)_* = 0$. In the case $S_1 = S_2 = \emptyset$, the condition (2) reads $H_1(M, \mathbb{Z}) = 0$.

the new basis the form $\begin{pmatrix} \pm 1 & & \mathbf{0} \\ & \ddots & \\ \mathbf{0} & & \pm 1 \\ & \mathbf{lk}'_{\text{TL}} & \end{pmatrix}$. Therefore, when writing down the relations in $H_1(M, \mathbb{Z})$

for the system of generators $\nu_1, \dots, \nu_{|L|}, \mu_{|L|+1}, \dots, \mu_{|L|+g_1+g_2}$, the generators ν_j , $j = 1, \dots, |L|$ can be eliminated, together with all relations, without adding any new relations. Hence $H_1(M, \mathbb{Z}) \cong \mathbb{Z}^{g_1+g_2}$, freely generated by $\mu_{|L|+1}, \dots, \mu_{|L|+g_1+g_2}$. The statement (3) now follows. \square

Proposition 6 *Suppose M is a connected compact oriented 3-manifolds with two distinguished (not necessarily connected) boundary components $\partial M = (-S_1) \cup S_2$, let f_1, f_2 be parametrizations of these surfaces, let N_1 and $\overline{N_2}$ be corresponding-to-the-genera disjoint unions of standard handlebodies, respectively anti-handlebodies, and let $i = (i_1, i_2) : \partial M \hookrightarrow M$ be the inclusion. The following conditions are equivalent:*

- (1) $H_1(\widehat{M}, \mathbb{Q}) = 0$
- (2) $H_1(M, \mathbb{Q}) = i_*(H_1(\partial M, \mathbb{Q}) / (f_1, -f_2)_* H_1(N_1 \sqcup -\overline{N_2}, \mathbb{Q}))$

They imply:

- (3) $2 \cdot \text{rank } H_1(M; \mathbb{Q}) = \text{rank } H_1(\partial M; \mathbb{Q})$

Proof. is identical to the proof of the previous proposition in every aspect, except that in the course of proving (1) \implies (3), $H_1(\widehat{M}, \mathbb{Q}) = 0$ implies only that the matrix of B is invertible (over \mathbb{Q}). The basis $\nu_1, \dots, \nu_{|L|}$ is then over \mathbb{Q} , i.e. it is a linear combination of $\mu_1, \dots, \mu_{|L|}$, but in general only with rational coefficients. Again, these ν -generators can be eliminated together with all relations. \square

Of cause, the conditions (3) in propositions 5 and 6 are equivalent.

A 3-cobordism satisfying the equivalent conditions (1), (2) of Proposition 5 (respectively 6) will be called a \mathbb{Z} -cobordism (respectively a \mathbb{Q} -cobordism). In both definitions we have allowed one or both S_i to be empty, although from the point of TQFT the case of empty top and/or bottom is indistinguished from the case when that component is S^2 .

Corollary 7 *If $H_1(\widehat{M}, \mathbb{Z}) = 0$, then $H_1(M, \mathbb{Z})$ is free of rank sum of the genera of its boundary components. More generally, $H_1(M, \mathbb{Z})$ can have only the kind of torsion $H_1(\widehat{M}, \mathbb{Z})$ has.*

Proof. The proof of proposition 6 can be repeated for \mathbb{Z}_p . Hence $\text{rank } H_1(M, \mathbb{Z}_p) = \text{rank } H_1(M, \mathbb{Q})$ for all p for which $H_1(\widehat{M}, \mathbb{Z}_p) = 0$, which implies that then p -torsion can not occur. In particular if M is a \mathbb{Z} -cobordism, this is true for all p . Apply the structure theorem for finitely generated abelian groups. \square

In general (3) does not imply (1) in the statement of the above propositions. For example, let M be the manifold obtained from S^3 by excising one component of the Hopf link in S^3 and performing surgery on the other. Then (3) is true, while (1) is not. But, if we restrict to 3-cobordisms those equivalence class is in the category \mathfrak{L} below, then such phenomena are excluded a priori (Proposition 9).

For connected ∂M condition (2) clearly implies $H_*(M; \partial M) = 0$. However, for example $\kappa(\emptyset, G, G')$ where G and G' are the components of the two-component unlink in S^3 , obviously satisfies (1), and hence (2), but fails to satisfy $H_*(M; S_i) = 0$, the second condition from the definition of an h-cobordism [12].

1.3 Description of the categories

We will be interested in three categories, $\mathfrak{Q} \supset \mathfrak{Z} \supset \mathfrak{L}$, which we now describe. Objects in each of these are *natural numbers*. The morphisms between g_1 and g_2 are certain equivalence (homeomorphism) classes of connected 3-cobordisms with connected bottom S_1 of genus g_1 and connected top S_2 of genus g_2 . The composition-morphism is the equivalence class of the 3-cobordisms in (1.1). The equivalence classes of the cobordisms $([D_g]_{L_0}, p_1, p_2)$, $g \geq 0$ play the rôle of identity in these categories.

Let us first describe some additional objects. Let L^a, L^b be the submodules of $H_1(\Sigma_g, \mathbb{Z})$ generated by a_i 's and b_i 's respectively. Each is a Lagrangian submodule with respect to the algebraic intersection form ω on $H_1(\Sigma_g, \mathbb{Z})$. Suppose M is a \mathbb{Q} -cobordism, with boundary $(-S_1) \cup S_2$. Let L_i , $i = 1, 2$ be

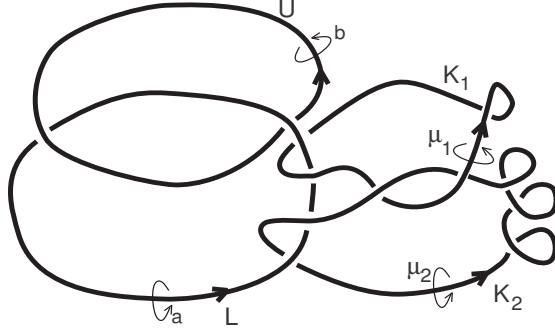

Figure 6: An example to illustrate that condition (1.3) over \mathbb{Q} is weaker than over \mathbb{Z} .

submodules of $H_1(S_i, \mathbb{Z})$, viewed inside $H_1(M, \mathbb{Z})$. We say that $L_1 \geq L_2$ in M , if every element in L_2 is \mathbb{Z} -homologically equivalent to an element in L_1 . (Or, intuitively, L_2 , which is in the homology of the component S_2 , can be “moved” to the part L_1 of the homology of the component S_1 .) Similarly we define $L_1 \leq L_2$. If $L_1 \geq L_2$ and $L_1 \leq L_2$, we have $L_1 = L_2$. Using the parametrizations of the boundary components, we can speak about the submodules L_i^a, L_i^b of $H_1(S_i)$, $i = 1, 2$, which correspond to L^a, L^b .

The morphisms in $\mathfrak{3}$ from g_1 to g_2 are equivalence classes of \mathbb{Z} -cobordisms with boundary $(-S_1) \cup S_2$ such that $g(S_i) = g_i$ and

$$L_1^a \geq L_2^a, \text{ and } L_1^b \leq L_2^b \tag{1.3}$$

Such \mathbb{Z} -cobordisms will be called **semi-Lagrangian**. An absolutely similar construction works for \mathfrak{Q} , just replace \mathbb{Z} by \mathbb{Q} .

Example *In general condition (1.3) over \mathbb{Z} is stronger than (1.3) over \mathbb{Q} .* Let (M, f_1, f_2) be a representative of the equivalence class of 3-cobordisms obtained by applying κ to the triplet $(K = K_1 \cup K_2, L, U)$ shown in figure 6. Let a, b, μ_1, μ_2 be the corresponding meridians. Then $H_1(M, \mathbb{Z})$ is the abelian group with the classes of these as generators, and relations $\mu_1 + \mu_2 + a = 0$ and $-3\mu_2 + \mu_1 - a = 0$. They imply that $2(\mu_1 - \mu_2) = 0$, i.e. $\mu_1 - \mu_2$ is a torsion element. $L_1^a, L_1^b, L_2^a, L_2^b$ are generated respectively by 1 element each, the classes of respectively a, L, U, b . Note that L is homologous to $\mu_1 - \mu_2 - b$, hence over \mathbb{Z} , $L_1^b \not\leq L_2^b$, but over \mathbb{Q} , $\mu_1 - \mu_2 = 0$, hence $L_1^b = L_2^b$. In this example $H_1(M, \mathbb{Z}) \cong \mathbb{Z}_4$, i.e. (M, f_1, f_2) is a \mathbb{Q} -cobordism, but not a \mathbb{Z} -cobordism. *If one assumes, however, that (M, f_1, f_2) is a \mathbb{Z} -cobordism, then conditions (1.3) over \mathbb{Z} and \mathbb{Q} are equivalent.* This follows from (2) in proposition 5, and from the fact that for \mathbb{Z} -cobordisms, L_2^a and L_1^b are free (by Proposition 7).

Note that if condition (1.3) is satisfied with equalities, then necessarily $g_1 = g_2$. ((1.3) is defined with the assumption that M is already a \mathbb{Q} -cobordism.)

Example *Condition (1.3) may hold with strict inclusion.* Consider $\kappa(\emptyset, G, G')$, where G is the braid-closure of a generator of the braid group B_2 , and G' is the braid axis (in S^3). In the case of integer homology both condition in (1.3) are strict, as it is easy to check. This example also shows that 3-cobordisms representing elements of the category $\mathfrak{3}$ do not necessarily satisfy $H_*(M; S_i) = 0$. (They are both $\cong \mathbb{Z}_2$ in this example.) It is not hard to see that if a homology-cobordism triad (M, S_1, S_2) is enhanced with parametrizations such that we get a \mathbb{Q} -cobordism, then the second condition from the definition of an h-cobordism [12] implies (1.3), and in fact with equalities. Hence, *if we restrict \mathbb{Q} -cobordism, requiring (1.3) contains all homology-cobordisms, and more.*

Proposition 8 *The composition of two morphisms (say, class of M and class of N) in category \mathfrak{Q} (resp. $\mathfrak{3}$) is again a morphism in the category \mathfrak{Q} (resp. $\mathfrak{3}$), i.e. \mathfrak{Q} and $\mathfrak{3}$ are categories.*

Proof. The fact that both M, N represent \mathbb{Q} -cobordism (respectively \mathbb{Z} -cobordism) means (by propositions 5 and 6) that all 1-dimensional homology (over \mathbb{Q} , respectively over \mathbb{Z}) in M can be considered as

in the boundary. So when we glue M with N along a surface S , the 1-dimensional homology is either in the top component of N , in the bottom component of M , or in the “middle” surface S . But now, by condition (1.3), all the cycles of type L^a in S can be moved down to the bottom, and all the cycles of type L^b can be moved up to the top. So the 1-dimensional homology is still sitting on the boundary. Since for any 3-cobordism (M, f_1, f_2) , $(i_1 \circ f_1)_* H_1(N_{g_1}, \mathbb{Z})$ is L_1^b , and $(i_2 \circ f_2)_* H_1(\overline{N}_{g_2}, \mathbb{Z})$ is L_2^a , using (1.3) one can verify condition (2) in Proposition 6 (respectively 5). Therefore $N \cup_{f_N \circ (f'_M)^{-1}} M$ is a \mathbb{Q} -cobordism (respectively a \mathbb{Z} -cobordism). For $N \cup_{f_N \circ (f'_M)^{-1}} M$ one can easily check (1.3). \square

The morphisms in the category \mathfrak{L} we define to be the equivalence classes of 3-cobordisms of the form $(M = \Sigma_g \times I, f, f')$, where $f, f' \in \text{Aut}(\Sigma_g)$, which are in \mathfrak{Q} . The following proposition shows that $\mathfrak{Q} \cap \mathfrak{L} = \mathfrak{Z} \cap \mathfrak{L}$, hence to require the equivalence class of $(\Sigma_g \times [0, 1], f, f')$ to be a morphism in category \mathfrak{Q} or \mathfrak{Z} is equivalent. Clearly, in \mathfrak{L} there are no morphisms between non-equal natural numbers. Recall that we use the following notation for the indices 1,2 and $'$: $(M_1, f_1, f'_1)(M_2, f_2, f'_2) = (M_2 \cup_{f_2 \circ (f'_1)^{-1}} M_1, f_1, f'_2)$.

Proposition 9 *Consider a 3-cobordism $M = (\Sigma_g \times [0, 1], f \times 0, f' \times 1)$, where the parametrization of the top differs by that of the bottom by the automorphism $w = (f')^{-1} \circ f$. Then its equivalence class depends only on the isotopy class of w (i.e. we don't need to specify both f, f'), and the following are equivalent:*

- (1) *the equivalence class of $(\Sigma_g \times [0, 1], f \times 0, f' \times 1)$ is a morphism in the category \mathfrak{L}*
- (2) *$L^a = w_*(L^a)$ and $L^b = w_*(L^b)$,*

In particular, \widehat{M} is a \mathbb{Z} -homology sphere.

Proof. $(\Sigma_g \times I, f \times 0, f' \times 1)$ is equivalent as a 3-cobordism to $(\Sigma_g \times I, ((f')^{-1} \circ f) \times 0 = w \times 0, id \times 1)$, therefore $\widehat{M} \cong (\Sigma_g \times I, \widehat{w \times 0}, id \times 1)$. As a 3-manifold, \widehat{M} is homeomorphic to $\overline{N}_g \cup_w N_g$. Using Mayer-Vietoris theorem for the decomposition $\overline{N}_g \cup_w N_g$ of \widehat{M} , we can see that condition (2) already ensures that M is a \mathbb{Z} -cobordism. Hence (2) \implies (1).

(1) \implies (2). Since w is a homeomorphism, w_* is an automorphism, hence by (1.3) w_* has to be an automorphism over \mathbb{Q} of each L^a, L^b . On the other side $w_*(L^a) \subset H_1(M, \mathbb{Z}) = L^a \oplus L^b$, and as a \mathbb{Z} -submodule of a free module, $w_*(L^a)$ must be free. Using this and the fact that $w_*(L^a) = L^a$ over \mathbb{Q} , we conclude $w_*(L^a) = L^a$ over \mathbb{Z} . Similarly $w_*(L^b) = L^b$ over \mathbb{Z} . \square

Suppose a closed 3-manifold is the result of gluing a standard handlebody N_g to the standard anti-handlebody \overline{N}_g along a homeomorphism w of the standard surface Σ_g , whose action on the homology (in the $a_1, \dots, a_g, b_1, \dots, b_g$ basis) is given by a symplectic matrix $\begin{pmatrix} A & B \\ C & D \end{pmatrix}$. By Mayer-Vietoris theorem this 3-manifold is a ZHS if and only if A is invertible. But the set of symplectic matrices $\begin{pmatrix} A & B \\ C & D \end{pmatrix}$ with A invertible is not closed under multiplication, as it is easy to notice from the following example: $\begin{pmatrix} 1 & 1 \\ 0 & 1 \end{pmatrix} \begin{pmatrix} 1 & 0 \\ -1 & 1 \end{pmatrix} = \begin{pmatrix} 0 & 1 \\ -1 & 1 \end{pmatrix}$. The result of gluing along each of the first two homeomorphisms (of $S^1 \times S^1$) is S^3 , while the result of gluing along their composition is $S^1 \times S^2$.

Corollary 10 *The composition of two cobordisms $(\Sigma_g \times I, f_1 \times 0, f'_1 \times 1) \cong (\Sigma_g \times I, w_1 \times 0, id \times 1)$ and $(\Sigma_g \times I, f_2 \times 0, f'_2 \times 1) \cong (\Sigma_g \times I, w_2 \times 0, id \times 1)$ along $(f_2 \times 0) \circ ((f'_1)^{-1} \times 1)$ (respectively $(w_2 \times 0) \circ (id \times 1)^{-1}$) is the 3-cobordism $(\Sigma_g \times I, f_2 \circ (f'_1)^{-1} \circ f_1 \times 0, f'_2 \times 1) \cong (\Sigma_g \times I, (f'_2)^{-1} \circ f_2 \circ (f'_1)^{-1} \circ f_1 \times 0, id \times 1) \cong (\Sigma_g \times I, (w_2 \circ w_1) \times 0, id \times 1)$. In particular, the composition of two morphisms of category \mathfrak{L} is again a morphism in the same category. \square*

Definition *Denote by \mathcal{L}_g the subgroup of the Mapping Class Group, consisting of isotopy classes of elements $w \in \text{Aut}(\Sigma_g)$ such that $w_*(L^a) = L^a$ and $w_*(L^b) = L^b$ (over \mathbb{Q} or over \mathbb{Z} , is equivalent by the previous proposition), and call it the **Lagrangian subgroup of the MCG**.*

TQFTs based on \mathfrak{Q} induce representations of \mathcal{L}_g . This subgroup of $MCG(g)$ is big enough to be interesting, it contains the Torelli group. In fact its image under the action on homology is the group of matrices of the form $\begin{pmatrix} A & 0 \\ 0 & (A^T)^{-1} \end{pmatrix}$, where $A \in GL(g, \mathbb{Z})$. This subgroup of $Sp(2g, \mathbb{Z})$ is not normal.

Proposition 9 above also shows that within this particular type ($M = \Sigma_g \times I$ and $w \in \mathcal{L}_g$), statement (3) from propositions 5 and 6 implies statement (1).

Remark. Let λ denote the Casson invariant of homology 3-spheres. By fixing the standard handlebody of genus g in $\mathbb{R}^3 \subset S^3$ we fixed a Heegaard homeomorphism that Morita [13] calls ι_g , and by taking the filling $(\Sigma_g \times I, \varphi, id)$ we obtain a manifold denoted by Morita W_φ . Every φ is a composition of Dehn twists $\tau_\gamma^{\pm 1}$. Using Proposition 2, we can "insert" $[D_g]_{L_0}$ between every two twists, or put it another way, express $(\Sigma_g \times I, \varphi, id)$ as a composition cobordisms $(\Sigma_g \times I, \tau_\gamma^{\pm 1}, id)$. Every twist can be replaced with ± 1 -surgery on a knot K_i . Hence we obtain W_φ as surgery on the link $L = K_1 \cup \dots \cup K_n \cup L_{0_1} \cup \dots \cup L_{0_{n-1}}$, such that if one removes L_0 's, then the remaining $K_1 \cup \dots \cup K_n$ is split. If $\varphi \in \mathcal{K}_g$, the kernel of the Johnson homomorphisms, then it is a composition of Dehn twists $\tau_\gamma^{\pm 1}$ on separating simple closed curves,⁴ i.e. γ has zero linking number with every circle component of L_0 's.

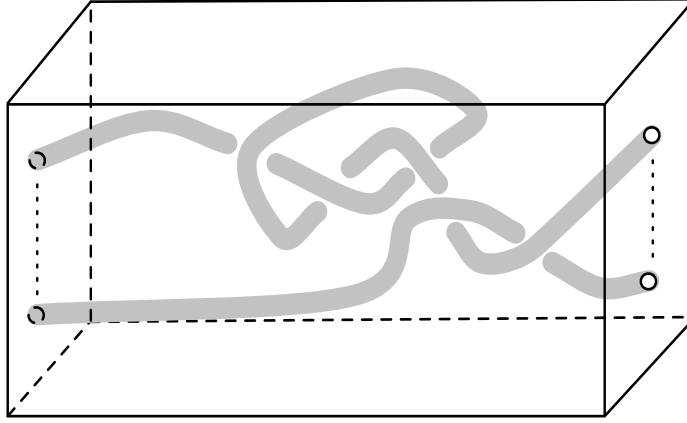

Figure 7: (L, G) less a tubular neighbourhood of the horizontal line of G .

Remark. Let \mathfrak{C}_\emptyset denote the set of connected 3-cobordisms with empty bottom and connected top. For $(M_1, \emptyset, f_1), (M_2, \emptyset, f_2) \in \mathfrak{C}_\emptyset$ and $(L_1, G_1) \subset S^3, (L_2, G_2) \subset S^3$ such that $\kappa(L_1, G_1) = (M_1, \emptyset, f_1), \kappa(L_2, G_2) = (M_2, \emptyset, f_2)$ ⁵, we can remove a tubular neighbourhood of the horizontal line of G_1 (= a ball in S^3), respectively of G_2 , and glue the two "boxes" as in figure 7, from left to right, afterwards filling back in the standard way a horizontal line. Denote the result by $(L_1 \cup L_2, G_1 \bullet G_2)$, and define:

$$(M_1, \emptyset, f_1) \bullet (M_2, \emptyset, f_2) = \kappa(L_1 \cup L_2, G_1 \bullet G_2) \tag{1.4}$$

Observe that the new 3-cobordism does not depend on the choice of pairs (L_i, G_i) . In the case of $g = 0$, \bullet is the connected sum, i.e. this operation is another way (alternative to composition of cobordisms) of generalizing the connected sum. Note that $(M_1, \emptyset, f_1) \bullet (M_2, \emptyset, f_2) = (M_1, \emptyset, f_1) \# (M_2, \emptyset, f_2)$. In particular the sets $\mathfrak{C}_\emptyset \cap \{\mathbb{Z}\text{-cobordism}\}$ and $\mathfrak{C}_\emptyset \cap \{\mathbb{Q}\text{-cobordism}\}$ are closed under \bullet . However, the Kontsevich-LMO invariant of 3-cobordisms [3,14] is not multiplicative with respect to \bullet , except in some particular cases.

Remark. One can consider a slightly modified version of the category \mathfrak{Q} , where the objects are connected parametrized surfaces (instead of natural numbers) and morphisms are certain classical (i.e. not parametrized) 3-cobordisms. Our choice here was motivated by our main example of TQFT (LMO), where \mathfrak{Q} gives the simplest formulations. In the next section one can replace it by a " \mathfrak{Q} -like category" instead.

⁴The problem of finding an algorithm to express an arbitrary $\varphi \in \mathcal{K}_g$ as a product of $\tau_\gamma^{\pm 1}$'s is unsolved.

⁵A pair (L, G) is similar to a triplet (\emptyset, L, G) .

2 TQFTs for the categories $\mathfrak{Q} \supset \mathfrak{Z} \supset \mathfrak{L}$

Define a TQFT (\mathcal{T}, τ) based on the cobordism category \mathfrak{Q} (or a subcategory of it, or a \mathfrak{Q} -like category) to be 1) a covariant functor \mathcal{T} from the category whose objects are the objects of \mathfrak{Q} (i.e. natural numbers) and morphisms are the homeomorphisms of parametrized surfaces to a subcategory \mathfrak{A}_K of the category of K -modules, such that $\mathcal{T}(0) = K$, where K is a commutative module with a conjugation operation; and 2) a map τ that associates to each 3-cobordism (M, f_1, f_2) a K -homomorphism $\tau(M) : \mathcal{T}(\Sigma_1) \rightarrow \mathcal{T}(\Sigma_2)$, satisfying the following axioms:

(A1) (*Naturality*) If $(M_1, \Sigma_1, \Sigma'_1)$, $(M_2, \Sigma_2, \Sigma'_2)$ are two 3-cobordisms, and $f : M_1 \rightarrow M_2$ is a homeomorphism of 3-cobordisms, preserving the parametrizations, then the following diagram is commutative:

$$\begin{array}{ccc} \mathcal{T}(\Sigma_1) & \xrightarrow{\tau(M_1)} & \mathcal{T}(\Sigma'_1) \\ \mathcal{T}(f|_{\Sigma_1}) \downarrow & & \downarrow \mathcal{T}(f|_{\Sigma_2}) \\ \mathcal{T}(\Sigma_2) & \xrightarrow{\tau(M_2)} & \mathcal{T}(\Sigma'_2) \end{array}$$

(A2) (*Functoriality*) If M_1, M_2 are 3-cobordisms, $f = f_2 \circ (f'_1)^{-1} : \partial_{top}(M_1) \rightarrow \partial_{bottom}(M_2)$ is the gluing homeomorphism, and denote $M = M_2 \cup_f M_1$, then $\tau(M) = k \cdot \tau(M_2) \circ \tau(M_1)$. $k \in K$ is called THE ANOMALY.

(A3) (*Normalization*) Let $(\Sigma \times [0, 1], (\Sigma \times 0, p_1), (\Sigma \times 1, p_2))$ be the 3-cobordism mentioned on page 4, then

$$\tau(\Sigma_g \times [0, 1], (\Sigma_g \times 0, p_1), (\Sigma_g \times 1, p_2)) = id_{\mathcal{T}(\Sigma_g)}$$

(A4) (*pseudo-Hermitian structure*) There is a superstructure on each element V of \mathfrak{A}_K , i.e. it admits an antimorphism $\bar{\cdot} : V \rightarrow V$ (a map linear in 0-supergrading and antilinear in 1-supergrading), that commutes with (= is natural with respect to) surface homeomorphisms. There is a canonical map $V \rightarrow V^*$, which composed with the above antimorphism extends (from the particular case when $\mathcal{T}(\Sigma_1) = K$) to an antimorphism $\bar{\cdot} : Mor(\mathcal{T}(\Sigma_1), \mathcal{T}(\Sigma_2)) \rightarrow Mor(\mathcal{T}(-\Sigma_2), \mathcal{T}(-\Sigma_1))$, that commutes with homeomorphisms of 3-cobordisms, such that

$$\tau(-M) = \overline{\tau(M)}$$

We can not require multiplicativity or self-duality since in the category \mathfrak{Q} all cobordisms are connected. Conditions (A1-A3) say that $\tau : \mathfrak{Q} \rightarrow \mathcal{A}$ is a pseudo-functor. τ would be a true functor when there is no anomaly. If the set of $\tau(M, S^2, \Sigma)$'s, spans (in the closure for infinite-dimensional modules) $\mathcal{T}(\Sigma)$, the TQFT is called *non-degenerate*.

2.1 The behavior of the signature and the determinant

Proposition 11 Let (M_1, f_1, f'_1) and (M_2, f_2, f'_2) be two 3-cobordisms. Suppose $(M_1, f_1, f'_1) = \kappa(L_1, G_1, G'_1)$, $(M_2, f_2, f'_2) = \kappa(L_2, G_2, G'_2)$, and $(M_2 \cup_{f_2 \circ (f'_1)^{-1}} M_1, f_1, f'_2) = \kappa(L_1 \cup L_0 \cup L_2, G_1, G'_2)$, the later triplet obtained from the previous two by the construction described in Proposition 3. Denote $\sigma_+^1 = sign_+(lk(L_1))$, $\sigma_+^2 = sign_+(lk(L_2))$, $\sigma_+ = sign_+(lk(L_1 \cup L_0 \cup L_2))$, and let g be the genus of the connected closed surface along which is this splitting. Then the integer $s(M, M_1, M_2) := \sigma_+^1 + \sigma_+^2 + g - \sigma_+$ is an invariant of the decomposition $M = M_2 \cup_{f_2 \circ (f'_1)^{-1}} M_1$, i.e. it does not depend on the choice of triplets representing the 3-cobordisms M_1 and M_2 .

Proof. Suppose we have another such choice of triplets. The new unoriented links L'_1 and L'_2 are related to L_1 and L_2 by a finite sequence of Kirby moves and changes of orientations of link components. Each such move can be thought of also as a move from $L'_1 \cup L_0 \cup L'_2$ to $L_1 \cup L_0 \cup L_2$. If a K-1 move changes σ_+^1 by ± 1 , then so does it to σ_+ , and hence $\sigma_+^1 + \sigma_+^2 + g - \sigma_+$ remains unchanged. Similarly happens if a K-1 move changes σ_+^2 . K-2 moves do not affect the signature. Indeed, recall that the operations of the type "add a j^{th} row and column to an i^{th} row and column" (which corresponds to sliding i^{th} component over

the j^{th} component of the link), do not change the signature of a symmetric matrix. They correspond to re-writing a symmetric bilinear form in a different basis, and Sylvester's inertia theorem applies. If the orientation of a link component of L_1 or L_2 changes, it corresponds to multiplying both linking matrices $lk(L_i)$ and $lk(L_1 \cup L_0 \cup L_2)$ on the left and on the right by a diagonal matrix with all entries 1 except one entry -1 . Hence again by Sylvester's theorem all signatures involved are invariant. \square

Note that $s(M, M_1, M_2)$ is not an invariant of a triad (in the sense of Milnor [12], i.e. if one ignores parametrizations).

Let (L, G, G') be a triplet and $(M, f, f') = \kappa(L, G, G')$. Recall that (see Proposition 5) we can talk about linking number between a link component K and a circle U of a chain graph, as well as between two circles U and V of chain graphs: $lk(K, U) = lk(U, K)$ = the linking number between K and the knot obtained from the graph by deleting all but the circle component U ; and similarly for $lk(U, V)$. We can then define *the linking matrix of a triplet*:

$$lk(L, G, G') = \begin{pmatrix} lk(L) & lk(L, G) & lk(L, G') \\ lk(G, L) & lk(G, G) & lk(G, G') \\ lk(G', L) & lk(G', G) & lk(G', G') \end{pmatrix} = \begin{pmatrix} A & B^T & C^T \\ B & D & E^T \\ C & E & F \end{pmatrix} \quad (2.1)$$

where A, D, F are symmetric matrices.

Let μ be the column-vector consisting of the meridians of L , m the column-vector of the meridians of G , and m' be the column-vector of the meridians of G' . Then $H_1(M, \mathbb{Z})$ is the \mathbb{Z} -module generated by the elements of μ, m, m' with $|L|$ relations – the elements of the column-vector $A\mu + B^T m + C^T m'$. The semi-Lagrangian conditions $L_1^b \leq L_2^b, L_2^a \leq L_1^a$ can be expressed $\mathbb{Z} \langle B\mu + Dm + E^T m' \rangle \leq \mathbb{Z} \langle m' \rangle$, respectively $\mathbb{Z} \langle C\mu + Em + Fm' \rangle \leq \mathbb{Z} \langle m \rangle$. If \widehat{M} is a \mathbb{Q} - or \mathbb{Z} -homology sphere, A is invertible over \mathbb{Q} . Moreover, $A^{-1} \in \mathcal{M}_{|L| \times |L|}(\mathbb{Z}[\frac{1}{\det A}])$. Therefore $\mu = -a^{-1}B^T m - A^{-1}C^T m'$. (This equality of column-vectors with entries in $\mathbb{Z}[\frac{1}{\det A}]$ has to be read over \mathbb{Z} , i.e. to mean that multiplying an entry on the left with the denominator of the corresponding entry on the right gives the numerator on the right side.) Hence the semi-Lagrangian conditions can be expressed $\mathbb{Z} \langle (D - BA^{-1}B^T)m + (E^T - BA^{-1}C^T)m' \rangle \leq \mathbb{Z} \langle m' \rangle$, respectively $\mathbb{Z} \langle (E - CA^{-1}B^T)m + (F - CA^{-1}C^T)m' \rangle \leq \mathbb{Z} \langle m \rangle$, i.e.

$$\begin{aligned} D &= BA^{-1}B^T \\ F &= CA^{-1}C^T \end{aligned} \quad (2.2)$$

(for \mathbb{Q} -cobordisms this in particular means that the entries on the left-hand side, a priori in $\mathbb{Z}[\frac{1}{\det A}]$, must be in \mathbb{Z}), and for \mathbb{Q} -cobordisms additionally:

$$BA^{-1}C^T \in \mathcal{M}_{g_1 \times g_2}(\mathbb{Z}) \quad (2.3)$$

We will need the following elementary

Lemma 12 *The signature of a symmetric $2g \times 2g$ -matrix $\begin{pmatrix} A & -I \\ -I & \mathbf{0} \end{pmatrix}$ with integer, respectively real entries is (g, g) . The determinant of such a matrix is $(-1)^g$. \square*

With these notations, Proposition 3 and (2.2) imply that the linking matrix $lk(L_1 \cup L_0 \cup L_2)$ is:

$$lk(L_1 \cup L_0 \cup L_2) = \begin{pmatrix} A & B^T & \mathbf{0} & \mathbf{0} \\ B & BA^{-1}B^T & -I & \mathbf{0} \\ \mathbf{0} & -I & DC^{-1}D^T & D \\ \mathbf{0} & \mathbf{0} & D^T & C \end{pmatrix} \quad (2.4)$$

where $A = lk(L_1) \in \mathcal{M}_{|L_1| \times |L_1|}(\mathbb{Z})$, $C = lk(L_2) \in \mathcal{M}_{|L_2| \times |L_2|}(\mathbb{Z})$, $B = lk(G'_1, L_1) \in \mathcal{M}_{g \times |L_1|}(\mathbb{Z})$, $D = lk(G_2, L_2) \in \mathcal{M}_{g \times |L_2|}(\mathbb{Z})$, $BA^{-1}B^T, DC^{-1}D^T \in \mathcal{M}_{g \times g}(\mathbb{Z})$. With the same notations:

Proposition 13 *The signature of the matrix (2.4) is $(\sigma_+^1 + \sigma_+^2 + g, \sigma_-^1 + \sigma_-^2 + g)$, where (σ_+^1, σ_-^1) , respectively (σ_+^2, σ_-^2) is the signature of $lk(L_1)$, respectively $lk(L_2)$. Also the following holds:*

$$\det(lk(L_1 \cup L_0 \cup L_2)) = (-1)^g \cdot \det(lk(L_1)) \cdot \det(lk(L_2)) \quad (2.5)$$

Proof. By the classification of quadratic forms with real coefficients there exist matrices $X \in SL(|L_1|, \mathbb{R})$, $Y \in SL(|L_2|, \mathbb{R})$ such that XAX^T and YCY^T are diagonal. Since A and C are symmetric, so are $BA^{-1}B^T$ and $DC^{-1}D^T$, hence there exist $P, Q \in SL(g, \mathbb{R})$ such that $PBA^{-1}B^T P^T$ and $QDC^{-1}D^T Q^T$ are diagonal. Then:

$$\begin{aligned} & \begin{pmatrix} X & \mathbf{0} & \mathbf{0} & \mathbf{0} \\ \mathbf{0} & P & \mathbf{0} & \mathbf{0} \\ \mathbf{0} & \mathbf{0} & Q & \mathbf{0} \\ \mathbf{0} & \mathbf{0} & \mathbf{0} & Y \end{pmatrix} \begin{pmatrix} A & B^T & \mathbf{0} & \mathbf{0} \\ B & BA^{-1}B^T & -I & \mathbf{0} \\ \mathbf{0} & -I & DC^{-1}D^T & D \\ \mathbf{0} & \mathbf{0} & D^T & C \end{pmatrix} \begin{pmatrix} X^T & \mathbf{0} & \mathbf{0} & \mathbf{0} \\ \mathbf{0} & P^T & \mathbf{0} & \mathbf{0} \\ \mathbf{0} & \mathbf{0} & Q^T & \mathbf{0} \\ \mathbf{0} & \mathbf{0} & \mathbf{0} & Y^T \end{pmatrix} = \\ & = \begin{pmatrix} XAX^T & XB^T P^T & \mathbf{0} & \mathbf{0} \\ PBX^T & PBA^{-1}B^T P^T & -PQ^T & \mathbf{0} \\ \mathbf{0} & -QP^T & QDC^{-1}D^T Q^T & QDY^T \\ \mathbf{0} & \mathbf{0} & YD^T Q^T & YCY^T \end{pmatrix} = \begin{pmatrix} \mathcal{D}_1 & F_1^T & \mathbf{0} & \mathbf{0} \\ F_1 & \mathcal{D}_2 & \mathcal{E}^T & \mathbf{0} \\ \mathbf{0} & \mathcal{E} & \mathcal{D}_3 & F_2 \\ \mathbf{0} & \mathbf{0} & F_2^T & \mathcal{D}_4 \end{pmatrix} \end{aligned}$$

where \mathcal{D}_i are diagonal matrices, \mathcal{D}_1 and \mathcal{D}_4 necessarily invertible, and $\mathcal{E} \in SL(g, \mathbb{R})$. Therefore:

$$\begin{aligned} & \begin{pmatrix} I & \mathbf{0} & \mathbf{0} & \mathbf{0} \\ -F_1 \mathcal{D}_1^{-1} & I & \mathbf{0} & \mathbf{0} \\ \mathbf{0} & \mathbf{0} & I & -F_2 \mathcal{D}_4^{-1} \\ \mathbf{0} & \mathbf{0} & \mathbf{0} & I \end{pmatrix} \begin{pmatrix} \mathcal{D}_1 & F_1^T & \mathbf{0} & \mathbf{0} \\ F_1 & \mathcal{D}_2 & \mathcal{E}^T & \mathbf{0} \\ \mathbf{0} & \mathcal{E} & \mathcal{D}_3 & F_2 \\ \mathbf{0} & \mathbf{0} & F_2^T & \mathcal{D}_4 \end{pmatrix} \begin{pmatrix} I & -(\mathcal{D}_1^{-1})^T F_1^T & \mathbf{0} & \mathbf{0} \\ \mathbf{0} & I & \mathbf{0} & \mathbf{0} \\ \mathbf{0} & \mathbf{0} & I & \mathbf{0} \\ \mathbf{0} & \mathbf{0} & -(\mathcal{D}_4^{-1})^T F_2^T & I \end{pmatrix} = \\ & = \begin{pmatrix} \mathcal{D}_1 & \mathbf{0} & \mathbf{0} & \mathbf{0} \\ \mathbf{0} & \mathcal{D}_2 - F_1 \mathcal{D}_1^{-1} F_1^T & \mathcal{E}^T & \mathbf{0} \\ \mathbf{0} & \mathcal{E} & \mathcal{D}_3 - F_2 \mathcal{D}_4^{-1} F_2^T & \mathbf{0} \\ \mathbf{0} & \mathbf{0} & \mathbf{0} & \mathcal{D}_4 \end{pmatrix} \end{aligned}$$

But $\mathcal{D}_2 - F_1 \mathcal{D}_1^{-1} F_1^T = PBA^{-1}B^T P^T - PBX^T \cdot (X^T)^{-1} A^{-1} X^{-1} \cdot XB^T P^T = \mathbf{0}$, and similarly $\mathcal{D}_3 - F_2 \mathcal{D}_4^{-1} F_2^T = \mathbf{0}$. Also observe that

$$\begin{pmatrix} I & \mathbf{0} \\ \mathbf{0} & -\mathcal{E}^{-1} \end{pmatrix} \begin{pmatrix} \mathbf{0} & \mathcal{E}^T \\ \mathcal{E} & \mathbf{0} \end{pmatrix} \begin{pmatrix} I & \mathbf{0} \\ \mathbf{0} & -(\mathcal{E}^{-1})^T \end{pmatrix} = \begin{pmatrix} \mathbf{0} & -I \\ -I & \mathbf{0} \end{pmatrix}$$

The later matrix, by Lemma 12, has signature (g, g) and determinant $(-1)^g$. Therefore the signature of the matrix (2.4) is $(\sigma_+^1 + \sigma_+^2 + g, \sigma_-^1 + \sigma_-^2 + g)$. Since all conjugations above were by matrices of determinant ± 1 , the determinant of the original matrix (2.4) remained unchanged, i.e. we also have the relation (2.5). \square

As immediate consequences we obtain the two central results of this paper:

Corollary 14 *For semi-Lagrangian \mathbb{Q} -cobordisms the integer $s(M, M_1, M_2)$ is always equal to 0.*

Corollary 15 *For semi-Lagrangian \mathbb{Q} -cobordisms (M, f_1, f_2) the cardinality of $H_1(\widehat{M}, \mathbb{Z})$ is multiplicative with respect to the composition of cobordisms.*

Remark. For the category $(\mathfrak{C}_0, \bullet)$ the same properties, with the integer $s := \sigma_+^1 + \sigma_+^2 - \sigma_+$, are obvious.

2.2 Consequences

Set $\mathcal{T}(f|_{\Sigma}) = id_{\mathcal{T}(g)}$ for any homeomorphism f of the parametrized surfaces. Then \mathcal{T} is a covariant functor, and the naturality axiom (A1) is obvious.

Basic example. Let N be an arbitrary integer, and $\tau(L) \in K^*$ an invariant of framed links, also invariant under the second Kirby move, and under changing orientation of link components. It is obvious that, if the linking matrix of L is non-singular and has signature (σ_+, σ_-) , and $M \equiv S_L^3$, then $\tau(M) = |H_1(M, \mathbb{Z})| \cdot \frac{\tau(L)}{\tau(\mathbf{0}^{+1})^{\sigma_+} \tau(\mathbf{0}^{-1})^{\sigma_-}}$ is an invariant of rational homology 3-spheres.

Assume the link invariant has two additional properties:

$$\tau(\overline{L}) = \overline{\tau(L)} \quad (2.6)$$

$$\tau(L_1 \cup L_0 \cup L_2) = \tau(L_1)\tau(L_2)\tau(\mathbf{O}^{+1})^g\tau(\mathbf{O}^{-1})^g \quad (2.7)$$

for any link L , $g \in \mathbb{N}$, and link $L_1 \cup L_0 \cup L_2$ obtained from L_1 and L_2 as follows: add arbitrary g components to L_i , and join the two links along the g additional componenets, preliminary inserting the tangle T_g (figure 4b) in between. The second property generalizes multiplicativity under connected sum. The firs property implies that $\tau(-M) = \overline{\tau(M)}$.

Let $\mathcal{T}(g)$, $g \geq 1$ be the K -vector space freely generated by homeomorphism classes of semi-Lagrangian \mathbb{Q} -cobordims of the form (P, s, h) , $s \cup h : \Sigma_0 \cup \Sigma_g \xrightarrow{\cong} \partial M$. The relation $\overline{[P, s, h]} = [P, s, h]$ defines a natural antimorphism on $\mathcal{T}(g)$. Defines $\tau(M, f, f')$ to be the K -homomorphism sending $[P, s, h] \in \mathcal{T}(g)$ to $\tau(\widehat{M}) \cdot [M \cup_{f \circ h^{-1}} P, s, f'] \in \mathcal{T}(g')$.

(A2) Observe that $\tau(\sigma_g \times [0, 1], p_1, p_2)$ sends $[P, s, h]$ to $\tau(S^3) \cdot [P, s, h] = [P, s, h]$;

(A3) If M_1 and M_2 are two cobordisms from \mathfrak{Q} , then $\tau(M_2 \cup M_1)$ sends $[P, s, h]$ to $|H_1(M_2 \cup M_1)|^N \cdot \frac{\tau(L_1 \cup L_0 \cup L_2)}{\tau(\mathbf{O}^{+1})^g + \tau(\mathbf{O}^{-1})^g} \cdot [M_2 \cup M_1 \cup P, s, f'_2]$, while $\tau(M_2) \circ \tau(M_1)$ sends it to $|H_1(M_2)|^N \cdot |H_1(M_1)|^N \cdot \frac{\tau(L_1)\tau(L_2)}{\tau(\mathbf{O}^{+1})^{\sigma_1^+ + \sigma_2^+} + \tau(\mathbf{O}^{-1})^{\sigma_1^- + \sigma_2^-}} \cdot [M_2 \cup M_1 \cup P, s, f'_2]$. These are equal by (2.7) and Corollaries 14 and 15;

(A4) For $[Q, r, j]^* \in \mathcal{T}(g)$ define the dual map $[Q, r, j]^*$ to send $[P, s, h]$ to $\tau(\widehat{Q}) \cdot \tau(-Q \cup_{j \circ h^{-1}} P, s, -r)$. Note that if one represents (M, f, f') by a triplet (Proposition 1), takes a generic projection on \mathbb{R}^2 , change all crossing to their opposites, and apply κ , one obtains the cobordism $(-M, -f', -f)$. Therefore defining $\tau(M, f, f') = \tau(-M, -f', -f)$ we obtain for the case when the domain of f is Σ_0 the composition $proj(*(\overline{\cdot}))$, where $proj : \mathcal{T}(\theta) \rightarrow K$, $proj[P, s, r] = \tau(\widehat{P})$.

If we replace $\mathcal{T}(\theta)$ by its image through $proj$, the above data defines a non-degenerate anomaly-free TQFT on \mathfrak{Q} .

Of cause, given a specific τ , one should define $\mathcal{T}(g)$, $\tau(M, f, f')$, the composition and conjugation in a way directly related to τ of links. Non-degeneracy should also be addressed in τ -sponceific terms. In [3] we use the results of this paper to construct a TQFT for the Le-Murakami-Ohtsuki invariant of QHS, as well as for its degree truncations.

Remark. Throughout this paper we have taken *oriented* chain graphs. This is motivated by the fact that for our main example (LMO) absence of orientation would induce unjustified complications. However for the correspondence in Proposition 1 here it sufices to consider banded (rather than framed) graphs with a specification of g meridional disks for its circle components (which would replace our notion of "horizontal line").

The TQFTs based on \mathfrak{Q} , when restricted to \mathfrak{L} produce linear representations $\mathcal{L}_g \rightarrow GL_K(\mathcal{T}(g))$. The group \mathcal{L}_g has not been studied before, no set of relations⁶ is known. Even, if we restrict to Torelli group, although a finite set of generators for \mathcal{T}_g is well-known [9], existence of a finite presentation is an open problem.

References

- [1] M.Atiyah, *Topological Quantum Field Theories*, Publications Mathématiques IHES **68** , 175-186 (1988)
- [2] C.Blanchet, H.Habegger, G.Masbaum, P.Vogel, *Topological quantum field theories derived from the Kauffman bracket*, *Topology* **34**, no.4, 883-927 (1995)
- [3] D.Cheptea, T.Le, *A TQFT associated to LMO invariant of three-dimensional manifolds*, math.GT.0508220 v2
- [4] F.Deloup, *An explicit construction of an abelian topological quantum field theory in dimension 3*, *Topology and Its Applications* **127**, no 1-2, 199-211 (2003)

⁶A set of generators can be easly obtained by taking products of generators of \mathcal{T}_g and of $GL(2, \mathbb{Z})$

- [5] A.Fomenko, S.Matveev, *Algorithmic and computer methods for three-manifolds*, Kluwer Academic Publishers (1997)
- [6] S.Gervais, *A finite presentation of the mapping class group of a punctured surface*, *Topology* **40**, no.4, 703-725 (2001)
- [7] R.E.Gompf, A.I.Stipsicz, *4-manifolds and Kirby calculus*, Graduate Studies in Mathematics **20**, AMS (1999)
- [8] K.Habiro, *Claspers and finite-type invariants of links*, *Geometry and Topology* **4**, 1-83 (2000)
- [9] D.Johnson, *The structure of the Torelli group I: A finite set of generators for \mathcal{T}* , *Annals of Mathematics* **118**, 423-442 (1983)
- [10] T.T.Q.Le, J.Murakami, T.Ohtsuki, *On a universal perturbative invariant of 3-manifolds*, *Topology* **37**, no.3, 539-574 (1998)
- [11] S.V.Matveev, *Generalized surgery of three-dimensional manifolds and representations of homology spheres*, *Matematicheskie Zametki* **42**, no.2, 268-278 (1986)
- [12] J.Milnor, *Lectures on the h-cobordism theorem*, Princeton University Press (1965)
- [13] S.Morita, *Casson's invariant for homology 3-spheres and characteristic classes of surface bundles I*, *Topology* **28**, no.3, 305-323 (1989)
- [14] J.Murakami, T.Ohtsuki, *Topological Quantum Field Theory for the Universal Quantum Invariant*, *Commun. Math. Phys.* **188**, 501-520 (1997)
- [15] V.Turaev, *Quantum Invariants of Knots and 3-Manifolds*, Walter de Gruyter (1994)
- [16] P.Vogel, *Invariants de type fini*, en "Nouveaux Invariants en Géométrie et en Topologie", publié par D. Bennequin, M. Audin, J. Morgan, P. Vogel, *Panoramas et Synthèses* **11**, Société Mathématique de France, 99-128 (2001)

Dorin Cheptea

UFR DE MATHÉMATIQUE ET D'INFORMATIQUE, UNIVERSITÉ LOUIS PASTEUR,
7, RUE RENÉ DESCARTES, 67084, STRASBOURG, FRANCE

AND

INSTITUTE OF MATHEMATICS, P.O.BOX 1-764, BUCHAREST, 70700, ROMANIA
E-MAIL: cheptea@math.u-strasbg.fr

Thang T Q Le

SCHOOL OF MATHEMATICS, GEORGIA INSTITUTE OF TECHNOLOGY,
ATLANTA, GA 30332-0160, USA

E-MAIL: letu@math.gatech.edu