

A VARIATIONAL PRINCIPLE FOR WEIGHTED DELAUNAY TRIANGULATIONS AND HYPERIDEAL POLYHEDRA

BORIS A. SPRINGBORN

ABSTRACT. We use a variational principle to prove an existence and uniqueness theorem for planar weighted Delaunay triangulations (with non-intersecting site-circles) with prescribed combinatorial type and circle intersection angles. Such weighted Delaunay triangulations may be interpreted as images of hyperbolic polyhedra with one vertex on and the remaining vertices beyond the infinite boundary of hyperbolic space. Thus the main theorem states necessary and sufficient conditions for the existence and uniqueness of such polyhedra with prescribed combinatorial type and dihedral angles. More generally, we consider weighted Delaunay triangulations in piecewise flat surfaces, allowing cone singularities with prescribed cone angles in the vertices. The material presented here extends work by Rivin on Delaunay triangulations and ideal polyhedra.

1. INTRODUCTION

1.1. Overview. Rivin developed a variational method to prove the existence and uniqueness of ideal hyperbolic polyhedra with prescribed combinatorial type and dihedral angles, or equivalently, of planar Delaunay triangulations with prescribed combinatorial type and circumcircle intersection angles [26]. The purpose of this article is to extend this method to hyperideal polyhedra and to weighted Delaunay triangulations. Consider a finite set of disjoint circular disks in the plane. For every triple of such disks there exists a circle that intersects the boundaries of the disks orthogonally. The weighted Delaunay triangulation induced by the disks consists of the triangles whose vertices are the centers of a triple of disks such that the orthogonal circle of this triple intersects no other disk more than orthogonally (see Figure 2). Such weighted Delaunay triangulations correspond to hyperbolic polyhedra with one vertex on the infinite boundary and all other vertices outside. The dihedral angles correspond to the intersection angles of the orthogonal circles. More generally, we allow cone singularities at the centers of the disks, and we call such weighted Delaunay triangulation with cone singularities euclidean hyperideal circle patterns. The question we consider is: Given an abstract triangulation \mathcal{T} with vertex set V , edge set E , and face set T , and given intersection angles θ as a function on the edges and cone angles Ξ as a function on the vertices, does there exist a corresponding euclidean hyperideal circle pattern, and is it unique? The main result is the following.

Theorem 1. *A euclidean hyperideal circle pattern with triangulation \mathcal{T} , intersection angles $\theta : E \rightarrow [0, \pi)$ and cone/boundary angles $\Xi : V \rightarrow (0, \infty)$ exists if and only if the set of coherent angle systems $\mathcal{A}(\mathcal{T}, \theta, \Xi)$ is not empty. In this case, the circle pattern is unique up to scale.*

Section 2 contains the basic definitions and a precise statement of the “circle pattern problem” under consideration. The set of coherent angle systems $\mathcal{A}(\mathcal{T}, \theta, \Xi)$

2000 *Mathematics Subject Classification.* Primary 51M20; Secondary 52C26, 57M50.
Supported by the DFG Research Center MATHEON in Berlin.

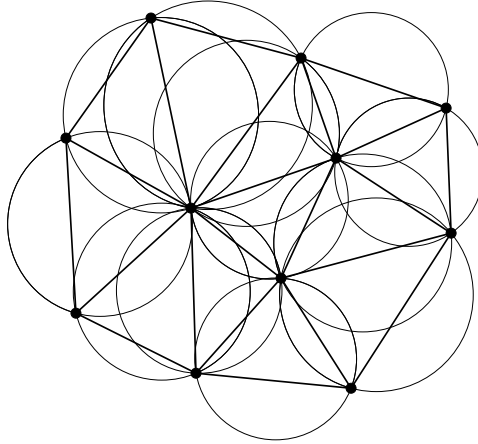

FIGURE 1. A Delaunay triangulation.

is defined in Section 2.5. It is a subset of $\mathbb{R}^{6|T|}$ defined by a system of linear equations and linear strict inequalities. The proof of Theorem 1 is based on the variational principle that is presented in Section 3, where a function $F : \mathbb{R}^{6|T|} \rightarrow \mathbb{R}$ is defined explicitly in terms of Milnor’s Lobachevsky function. The critical points of F in $\mathcal{A}(\mathcal{T}, \theta, \Xi)$ correspond to solutions of the circle pattern problem (Lemma 1). The uniqueness of a solution follows immediately from the fact that the function F is strictly concave on $\mathcal{A}(\mathcal{T}, \theta, \Xi)$ (Lemma 2). To prove the existence of a solution, we show that F cannot attain its maximum on the boundary $\overline{\mathcal{A}(\mathcal{T}, \theta, \Xi)} \setminus \mathcal{A}(\mathcal{T}, \theta, \Xi)$ (Lemma 3). Sections 4–6 are devoted to the proofs of these three main lemmas. The explicit formula for the function F is based on a hyperbolic volume formula which is derived in Section 7.

The variational principle presented here is not only a tool to prove the existence and uniqueness Theorem 1. Since it reduces the circle pattern problem to a convex optimization problem with linear constraints, it provides a means for its numerical solution. This is important in view of possible applications, such as using circle patterns to map 3D triangle meshes to the plane.

Different necessary and sufficient conditions for the existence of hyperideal circle patterns were obtained by Bao & Bonahon [4] and by Schlenker [32]. We discuss these results in Section 1.3.

1.2. Delaunay triangulations and hyperbolic polyhedra. “Patterns of circles” have become objects of mathematical interest after Thurston introduced them as elementary and intuitive images of polyhedra in hyperbolic 3-space [35]. Thus, a planar Delaunay triangulation (*i.e.* a triangulation of a convex polygonal region with the property that the circumcircle of each triangle does not contain any vertices in its interior, see Figure 1) can be viewed as representation of a convex hyperbolic polyhedron with all vertices in the infinite boundary of hyperbolic space: Erase all interior edges, keep only the circumcircles and the boundary edges, and extend the boundary edges to straight lines. Consider the paper plane as the infinite boundary of hyperbolic space, represented in the Poincaré half-space model. In this model, hyperbolic planes are represented by hemispheres and half-planes which intersect the infinite boundary orthogonally in circles and lines, respectively. Therefore, if we erect hemispheres and orthogonal half-planes over the circumcircles and the prolonged boundary edges, we obtain a set of hyperbolic planes which bound a convex polyhedron. This polyhedron’s vertices are the vertices of the Delaunay triangulation and one additional point, the infinite point of the boundary plane, where all

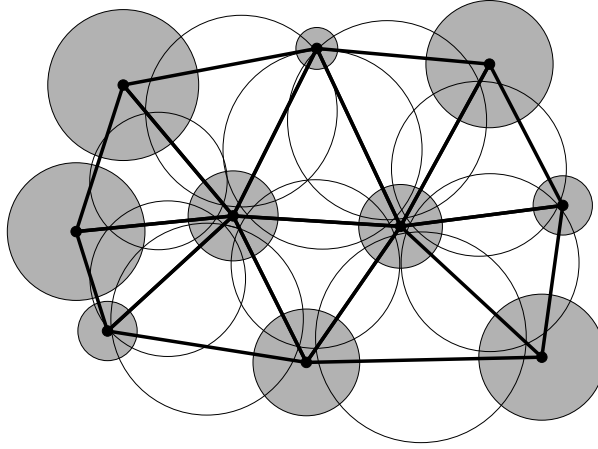

FIGURE 2. A weighted Delaunay triangulation. Note that the intersection points of two adjacent face-circles lie on the edge between them.

the hyperbolic planes corresponding to the boundary edges intersect. Moreover, the dihedral angle at an edge of the polyhedron is equal to the angle in which the corresponding circles/lines intersect.

A point in the infinite boundary of hyperbolic space is called an *ideal point*, and a polyhedron with all vertices in the ideal boundary is called an *ideal polyhedron*. This terminology has become widely accepted; in the old literature, the term “ideal point” was used for points *beyond* the ideal boundary, which are now called *hyperideal points*. If we consider Delaunay triangulations up to similarity and hyperbolic polyhedra up to isometry, then the construction above establishes a 1-to-1 correspondence between planar Delaunay triangulations and convex ideal polyhedra with one marked vertex. (Essentially the same construction, but represented in the projective model of hyperbolic space with a paraboloid as the absolute quadric, is known in Discrete Geometry as the “convex hull construction”.)

Weighted Delaunay triangulations are a well known generalization of Delaunay triangulations [15], where the sites are not points but circles (vertex-circles). We consider only the case where the closed disks bounded by the vertex-circles are pairwise disjoint. Instead of an empty circumcircle, to each triangle there corresponds a circle (face-circle) which intersects the adjacent vertex-circles orthogonally and which intersects no vertex-circle more than orthogonally (see Figure 2). Weighted Delaunay triangulations with non-intersecting vertex circles correspond to hyperbolic polyhedra with hyperideal vertices but with edges still intersecting hyperbolic space. Hyperideal points are not represented as such in the Poincaré half-space model. In the projective model, they are simply represented by the points outside the absolute quadric. The plane that is polar to such a point (with respect to the absolute quadric) intersects the absolute quadric, hence it represents a hyperbolic plane. Thus, hyperideal points are in 1-to-1 correspondence with hyperbolic planes. Two hyperbolic planes intersect orthogonally iff one is incident with the hyperideal point polar to the other. The correspondence between Delaunay triangulations and hyperbolic polyhedra extends to weighted Delaunay triangulations: *A weighted Delaunay triangulation with non-intersecting vertex circles corresponds to a convex hyperbolic polyhedron with one marked ideal vertex and all other vertices hyperideal, and with edges intersecting hyperbolic space.* The problem we will consider is to construct such polyhedra with prescribed combinatorial type and

dihedral angles. More generally, we will also consider weighted Delaunay triangulations in piecewise flat surfaces with cone singularities with prescribed cone angle at the vertices. These correspond to certain non-compact hyperbolic cone manifolds with polyhedral boundary where the lines of curvature connect one marked ideal vertex with the other hyperideal vertices.

1.3. Related work. For a comprehensive bibliography on circle packings and circle patterns we refer to Stephenson's monograph [34]. Here, we can only attempt to briefly discuss some of the most important and most closely related results.

Let \mathcal{C} be a cellulation of the 2-sphere and suppose there is a weight $\theta_e \in (0, \pi)$ attached to each edge e . Does there exist a hyperbolic polyhedron that is combinatorially equivalent to \mathcal{C} and whose exterior dihedral angles are the weights θ_e ; and if so, is it unique? A complete answer to this question is unknown. Andreev gave an answer for compact polyhedra with non-obtuse dihedral angles [2] (see also [29]), and he extended his result to non-obtuse angled polyhedra with finite volume, some or all vertices of which may be in the sphere at infinity [3]. An analogous existence and uniqueness theorem for circle patterns in surfaces of non-positive Euler characteristic is due to Thurston [35]. The intersection angles have to be non-obtuse but this theorem also allows the circle pattern equivalent of hyperideal vertices. Chow & Luo [10] gave a proof which is inspired by work on the Ricci flow on surfaces. They also show that there is a variational principle for this circle pattern problem, but only the derivatives of the functional are known.

Rivin classified convex ideal polyhedra without any restriction to non-obtuse dihedral angles:

Theorem 2 (Rivin [27]). *There exists an ideal polyhedron that is combinatorially equivalent to a cellulation \mathcal{C} of S^2 and that has prescribed exterior dihedral angles $\theta_e \in (0, \pi)$ iff for each cycle γ in the 1-skeleton of the dual cellulation \mathcal{C}^* the inequality*

$$\sum_{e^* \in \gamma} \theta_e \geq 2\pi \tag{1}$$

holds and equality holds iff γ is the boundary of a face of \mathcal{C}^ . If it exists, the polyhedron is unique.*

Bao and Bonahon generalized Rivin's result for polyhedra with all vertices *on or beyond* the sphere at infinity:

Theorem 3 (Bao & Bonahon [4]). *There exists a polyhedron with ideal and hyperideal vertices and with edges intersecting hyperbolic space that is combinatorially equivalent to a cellulation \mathcal{C} of S^2 and has prescribed exterior dihedral angles $\theta_e \in (0, \pi)$ iff the following conditions hold:*

(i) For each cycle γ in the 1-skeleton of the dual cellulation \mathcal{C}^ the inequality (1) holds and equality may hold only if γ is the boundary of a face of \mathcal{C}^* .*

(ii) For each simple path γ in the 1-skeleton of the dual cellulation \mathcal{C}^ that joins two different vertices of a face v^* of \mathcal{C}^* and that is not contained in the boundary of v^* , $\sum_{e^* \in \gamma} \theta_e > \pi$.*

If it exists, the polyhedron is unique.

Andreev, Rivin, and Bao & Bonahon obtain their results by employing variants the *method of continuity* (or *deformation method*) that was pioneered by Alexandrov [1]. Schlenker gave a different proof of Bao & Bonahon's Theorem [31].

A variational approach to construct ideal hyperbolic polyhedra and, more generally, Delaunay triangulations of piecewise flat surfaces was also provided by Rivin [26]. The basic idea is to build an ideal polyhedron by gluing together ideal tetrahedra, or equivalently, to build a Delaunay triangulation by gluing together

triangles. The angles of the triangles are considered as variables. They have to satisfy simple linear equality and inequality constraints: They have to be positive and the three angles in each triangle have to sum to π . The angles around a vertex have to sum to 2π (more generally, some specified cone angle). Finally, to get the right circle intersection angles, the angles opposite an edge e have to sum to $\pi - \theta_e$. Using Colin de Verdière’s terminology [12], we call an assignment of values to the angle variables that satisfies these constraints a *coherent angle system*. A coherent angle system does in general not represent a Delaunay triangulation because for the triangles to fit together, further non-linear conditions on the angles have to be satisfied. Nevertheless, the following theorem holds.

Theorem 4 (Rivin [26]). *Let \mathcal{S} be a cellulation of a surface, let an intersection angle $\theta_e \in [0, \pi)$ be assigned to each edge e and a cone angle Ξ_v be assigned to each vertex v . There exists a Delaunay triangulation of a piecewise flat surface that is combinatorially equivalent to \mathcal{S} and has intersection angles θ and cone angles Ξ if and only if the above constraints on the angle variables are feasible, i.e. if a coherent angle system exists. In that case, the Delaunay triangulation is unique up to scale.*

Note that the necessary and sufficient conditions of Theorem 2, involving inequalities of sums of intersection angles over paths, are very different from the conditions of Theorem 4, involving the existence of a coherent angle system. There is also a third type of conditions for the existence of a Delaunay triangulation of a piecewise flat surface with prescribed intersection angles and cone angles that was first obtained by Bowditch [8]. It is by no means a triviality to directly derive one type of conditions from another type [28] [6]. A variant of Rivin’s variational approach for Delaunay decompositions of *hyperbolic* surfaces was developed by Leibon [19]. In this article, we extend Rivin’s variational approach to euclidean weighted Delaunay triangulations with non-intersecting vertex circles. The main Theorem 1 is of the type “a weighted Delaunay triangulation exists uniquely iff a coherent angle system exists.” The scope of Theorem 1 has non-empty intersection with Bao & Bonahon’s Theorem 3. Both cover hyperbolic polyhedra with hyperideal vertices and precisely one ideal vertex. But the conditions are of a different type and not obviously equivalent. Theorem 1 also covers weighted Delaunay triangulations in flat tori and, more generally, in piecewise flat surfaces, possibly with boundary. The variational method is better suited for numerical computation.

Recently, Schlenker has treated weighted Delaunay triangulations in piecewise flat and piecewise hyperbolic surfaces using a deformation method [32]. He obtains an existence and uniqueness theorem [32, Theorem 1.4] with the same scope as Theorem 1, but the conditions for existence are in terms of angle sums over paths like in Theorem 3. This seems to be the first time that this type of conditions was obtained for circle patterns with cone singularities. It would be interesting to show directly that the conditions of his theorem are equivalent to the conditions of Theorem 1.

Circle patterns have been applied to map 3D triangle meshes quasi-conformally to the plane. To improve these methods was an important motivation for this work. The group around Stephenson first used circle packings (circles touching without overlap) to construct planar maps of the human cerebellum [16]. This original method only takes the combinatorics of the input mesh into account. A later version uses so called *inversive distance packings* [9]. (The *inversive distance* of two non-intersecting circles is the cosh of the hyperbolic distance of the two planes they represent.) Inversive distance packings are similar to the weighted Delaunay triangulations considered here except that the inversive distances of the vertex-circles are prescribed instead of the intersection angles of the face-circles, and there is no

Delaunay criterion. Unfortunately, no existence and uniqueness theorem for inversive distance packings is known. Kharevych *et al.* [18] proceed along a different path. They first read off the intersection angles between circumcircles of the 3D triangle mesh. Then they construct a planar Delaunay triangulation with intersection angles as close to the measured angles as possible. To construct the Delaunay triangulation they use a variational principle by Bobenko & Springborn [6], which is related to Rivin's via a Legendre transformation. It has the advantage that the variables are (logarithmic) circle radii which are not subject to any constraints. However, the prior angle-adjustment is achieved by solving a quadratic programming problem, which is the most complicated and computationally most expensive stage of the algorithm. One may hope that using weighted Delaunay triangulations will provide a way to escape the tight constraints that have to be satisfied by the intersection angles of a Delaunay triangulation without giving up all mathematical certainty regarding existence and uniqueness. Another interesting question is this: Can one formulate a dual variational principle for weighted Delaunay triangulations, with an *explicit formula* for the functional, where the variables are circle radii and inversive distances?

ACKNOWLEDGMENTS

The research for this article was conducted almost entirely while I enjoyed the hospitality of the *Mathematisches Forschungsinstitut Oberwolfach*, where I participated in the Research in Pairs Program together with Jean-Marc Schlenker, who was working on his closely related paper [32]. I am grateful for the excellent working conditions I experienced in Oberwolfach and for the extremely inspiring and fruitful discussions with Jean-Marc, who was closely involved in the work presented here.

2. EUCLIDEAN HYPERIDEAL CIRCLE PATTERNS

2.1. Basic definitions. A *surface* is a two-dimensional manifold, possibly with boundary. A *triangulated surface* \mathcal{T} (or *triangulation* for short) is a two-dimensional CW complex whose total space is a surface S and which has the property that for each two-cell attaching map $\sigma : B^2 \rightarrow S$ the set $\sigma^{-1}(V)$ contains three points, where V is the vertex set (zero-skeleton) of the CW complex.

This definition allows non-regular triangulations. A cell complex is called *regular* if the cell attaching homomorphisms embed the closed cells. A cell complex is called *strongly regular* if it is regular and the intersection of two closed cells is empty or a closed cell. The usual definition of simplicial complexes implies that they are strongly regular. Throughout this paper we assume all triangulations to be regular, *but only to simplify notation*. We will label vertices by i, j, k, \dots and denote edges by pairs ij and triangles by triples ijk . However, this regularity assumption is not essential for the material presented here; everything holds for non-regular triangulations as well.

We denote the set of vertices, edges, and triangles of a triangulation \mathcal{T} by V, E , and T , respectively. Throughout this paper, all triangulations are assumed to be finite.

A *triangulated piecewise flat surface* (\mathcal{T}, d) is a triangulated surface \mathcal{T} equipped with a metric d such that for each two-cell attaching map $\sigma : B^2 \rightarrow S$ the closed disk B^2 equipped with the pulled back metric σ^*d is a euclidean triangle, and σ maps the vertices of this triangle to vertices of the CW complex. In other words, a triangulated piecewise flat surface is a surface obtained by glueing together euclidean triangles along their sides. (Of course, sides that are identified by glueing must have the same length.) The metric d is flat except in the vertices of the

triangulation where it may have cone-like singularities. The *cone angle* at a vertex i is the sum of all triangle angles incident at i . If the cone angle at a vertex is 2π then the metric is flat there. A triangulated piecewise flat surface is determined by the triangulation \mathcal{T} and the function $l : E \rightarrow \mathbb{R}_{>0}$ that maps each edge $ij \in E$ to its length l_{ij} . For each triangle $ijk \in T$, the lengths l_{ij}, l_{jk}, l_{ki} satisfy the triangle inequalities. Conversely, a triangulation \mathcal{T} and a function $l : E \rightarrow \mathbb{R}_{>0}$ that satisfies the triangle inequalities for each triangle determines a triangulated piecewise flat surface.

A *euclidean hyperideal circle pattern* is a triangulated piecewise flat surface together with a function $r : V \rightarrow \mathbb{R}_{>0}$ with the following two properties.

(i) For each edge $ij \in E$, $r_i + r_j < l_{ij}$, where l_{ij} is the length of the edge.

Let $ijk \in T$ be a triangle of the triangulation \mathcal{T} . If we draw a triangle with sides l_{ij}, l_{jk} and l_{ki} in the euclidean plane and circles with radii r_i, r_j and r_k around the vertices, then the property (i) simply says that these circles do not touch or intersect. Consequently there exists a unique fourth circle that intersects all three circles orthogonally. The second condition concerns these orthogonally intersecting circles.

(ii) Let $ij \in E$ be an *interior* edge. Let ijk and jil be the adjacent triangles on either side. (These may actually be one and the same triangle if the triangulation is not regular.) Draw two abutting triangles with the same side lengths in the euclidean plane, and draw circles with radii r_i, r_j, r_k and r_l around the vertices. Then the orthogonal circle through the vertex-circles of one triangle intersects the fourth vertex-circle either not at all or at an angle that is less than $\frac{\pi}{2}$.

In other words, a euclidean hyperideal circle pattern is a weighted Delaunay triangulation with non-intersecting vertex-circles in a piecewise flat surface. (Note that condition (ii) invokes an edge-local Delaunay condition. This raises the question whether it is also true for piecewise flat surfaces that the local condition implies the global condition that no face-circle intersects any vertex-circle more than orthogonally. Such questions shall not be treated here. We refer to Bobenko & Springborn [7] and Bobenko & Izmistiev [5] for a more thorough treatment of Delaunay triangulations and weighted Delaunay triangulations in piecewise flat surfaces.)

Just as a triangulated piecewise flat surface is obtained by glueing together euclidean triangles along the edges, a euclidean hyperbolic circle pattern is obtained by putting together triangles which are decorated by circles as shown in Figure 3.

2.2. Interpretation as hyperbolic polyhedra. By the construction explained in Section 1.2, the decorated triangle shown in Figure 3 may be interpreted as a tetrahedron in three-dimensional hyperbolic space with one vertex on the sphere at infinity and three vertices beyond that sphere, as shown in Figure 4. The sides of the triangle and the face-circle that intersects the three vertex-circles orthogonally correspond to hyperbolic planes that bound a tetrahedron with one ideal and three hyperideal vertices, which are represented by the vertex-circles.

If we can put together the decorated triangles to form a circle pattern, we can also glue the corresponding hyperbolic tetrahedra to form a hyperbolic cone manifold with polyhedral boundary. Such a glueing will identify the ideal vertices of all tetrahedra. The resulting point will either be an ideal vertex if \mathcal{T} has boundary or a cusp of the hyperbolic manifold if \mathcal{T} is closed. The hyperideal vertices of the tetrahedra will be identified in groups corresponding to vertices of \mathcal{T} to form hyperideal vertices of the polyhedral boundary. There will in general be cone lines running from the cusp or ideal vertex to the hyperideal vertices. If the circle pattern has no curvature at the vertices, we obtain a non-compact hyperbolic manifold with

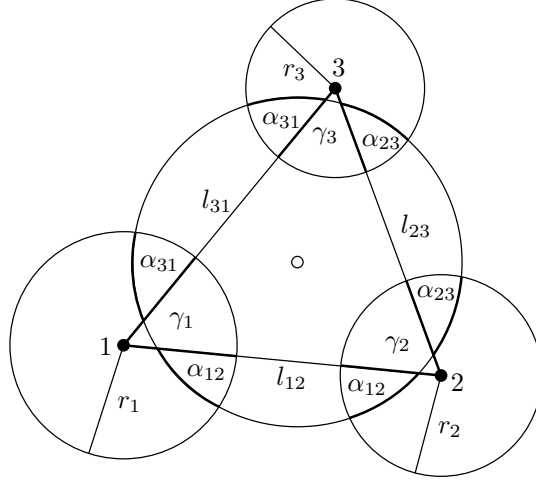

FIGURE 3. Local geometry at a triangle.

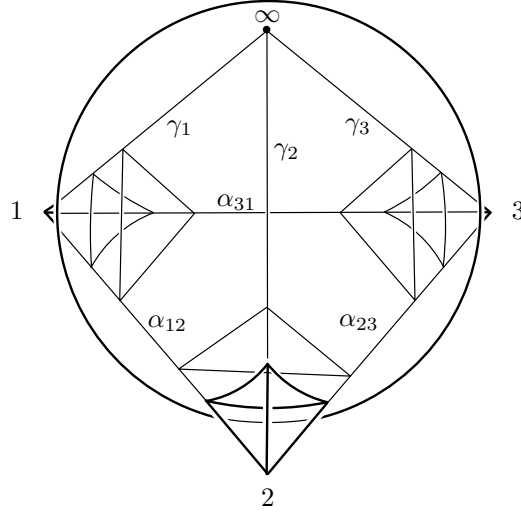

FIGURE 4. A tetrahedron in hyperbolic space (shown in the projective model) with one ideal vertex and three hyperideal vertices. The tetrahedron is truncated by the polar planes of the hyperideal vertices.

polyhedral boundary. If in addition the triangulation \mathcal{T} is topologically a disk, we obtain a convex hyperbolic polyhedron with one ideal vertex all others hyperideal.

2.3. The circle pattern problem. From a euclidean hyperideal circle pattern one can read off the following data:

- A triangulated surface \mathcal{T} .
- For each vertex $i \in V$, the sum $\Xi_i \in (0, \infty)$ of incident triangle angles. For an interior vertex, this is the cone angle at i , and $\Xi_i = 2\pi$ if the circle pattern is flat at i . For a boundary vertex, Ξ_i is the interior angle of the polygonal boundary at i .
- For each interior edge $ij \in E$, the intersection angle $\theta_{ij} \in [0, \pi)$ of the orthogonal circles corresponding to the two adjacent triangles ijk and jil . An intersection angle $\theta_{ij} = 0$ means that the orthogonal circles of triangles ijk and jil coincide.

- For each boundary edge $ij \in E$, the intersection angle, also denoted by θ_{ij} , of the orthogonal circle corresponding to the adjacent triangle ijk with the line segment containing the edge ij . The range of these intersection angles at boundary edges is $\theta_{ij} \in (0, \pi)$.

We consider the following *circle pattern problem*: Given an abstract triangulation \mathcal{T} and angle data $\Xi : V \rightarrow (0, \infty)$, $\theta : E \rightarrow [0, \pi)$ find a corresponding euclidean hyperideal circle pattern.

2.4. Local geometry at a triangle. Consider a geometric figure consisting of a euclidean triangle with three non-touching and non-intersecting circles centered at the vertices and a fourth circle intersecting the other three orthogonally. Let α_{12} , α_{23} , α_{31} , γ_1 , γ_2 , γ_3 be the angles shown in Figure 3. They are positive,

$$\alpha_{ij} > 0, \quad \gamma_j > 0, \quad (2)$$

satisfy the angle sum equation

$$\gamma_1 + \gamma_2 + \gamma_3 = \pi, \quad (3)$$

and the inequalities

$$\begin{aligned} \gamma_1 + \alpha_{12} + \alpha_{31} &< \pi, \\ \gamma_2 + \alpha_{23} + \alpha_{12} &< \pi, \\ \gamma_3 + \alpha_{31} + \alpha_{23} &< \pi. \end{aligned} \quad (4)$$

Let

$$\Delta = \{(\alpha_{12}, \alpha_{23}, \alpha_{31}, \gamma_1, \gamma_2, \gamma_3) \in \mathbb{R}^6 \text{ satisfying (2), (3), and (4)}\}.$$

Conversely, if $(\alpha_{12}, \alpha_{23}, \alpha_{31}, \gamma_1, \gamma_2, \gamma_3) \in \Delta$, then there exists one such figure with these angles, and only one up to similarity. Indeed, the construction of such a figure is simple: Draw any circle in the plane. (This fixes the scale and translational degrees of freedom.) Then draw a line intersecting it at the angle α_{12} . (This fixes the remaining rotational degree of freedom.) Then draw the other two lines intersecting the circle and the first line at the prescribed angles. The inequalities (4) ensure that the lines intersect outside the face-circle and that the orthogonal vertex-circles do not intersect each other.

2.5. Coherent angle systems. Let \mathcal{T} be a triangulation with triangle set T , edge set E , and vertex set V . We label the coordinates of points in $\mathbb{R}^{6|T|}$ by $\alpha_{ij}^t, \gamma_i^t$ where $t \in T$ is a triangle and $i, j \in t$ are vertices of t . We fix this labeling once and for all. Let $\Xi : V \rightarrow (0, \infty)$ be a function on the vertices and $\theta : E \rightarrow [0, \pi)$ be a function on the edges. The *space of coherent angle systems* $\mathcal{A}(\mathcal{T}, \theta, \Xi)$ is the set of all points $(\alpha, \gamma) \in \mathbb{R}^{6|T|}$ such that

- for each triangle $t = ijk \in T$

$$(\alpha_{ij}^t, \alpha_{jk}^t, \alpha_{ki}^t, \gamma_i^t, \gamma_j^t, \gamma_k^t) \in \Delta,$$

- for each interior edge $ij \in E$

$$\alpha_{ij}^t + \alpha_{ji}^{t'} = \pi - \theta_{ij}, \quad (5)$$

where $t, t' \in T$ are the adjacent triangles on either side of edge ij ,

- for each boundary edge $ij \in E$, $\theta_{ij} > 0$ and

$$\alpha_{ij}^t = \pi - \theta_{ij}, \quad (6)$$

where t is the triangle incident with edge ij ,

- for each vertex $i \in V$

$$\sum_{t \in T: i \in t} \gamma_i^t = \Xi_i. \quad (7)$$

A *coherent angle system* is an element of $\mathcal{A}(\mathcal{T}, \theta, \Xi)$. If $\mathcal{A}(\mathcal{T}, \theta, \Xi)$ is not empty, then the closure $\overline{\mathcal{A}(\mathcal{T}, \theta, \Xi)}$ is a compact polytope in $\mathbb{R}^{6|T|}$, and $\mathcal{A}(\mathcal{T}, \theta, \Xi)$ is its relative interior.

2.6. Existence and uniqueness. The main Theorem 1 reduces the question of existence and uniqueness of a solution of the circle pattern problem of Section 2.3 to a linear feasibility problem. The “only if” part of the theorem—if a circle pattern exists then a coherent angle system exists—is trivial, since one can simply read off a coherent angle system from a euclidean hyperideal circle pattern. The “if” part—if a coherent angle system exists then a circle pattern exists—is not trivial, and the rest of this paper is devoted to proving it. It is *not* true that for each coherent angle system there exists a euclidean hyperideal circle pattern with these angles. While it *is* true that a coherent angle system determines up to similarity a geometric figure as shown in Figure 3 for each triangle of the triangulation, these figures cannot in general be put together to form a circle pattern. The relative scale of the two figures corresponding to neighboring triangles is determined by the condition that the triangle edges to be glued together must have the same length. But the two pairs of corresponding vertex circles in the two figures will in general not have matching radii. Even if we disregarded the vertex circles, it is in general not possible to choose consistently a scale for each triangle such that the corresponding sides of triangles that are to be glued together have the same length.

3. A VARIATIONAL PRINCIPLE

The space $\mathcal{A}(\mathcal{T}, \theta, \Xi) \subset \mathbb{R}^{6|T|}$ of coherent angle systems is defined by *linear* equations and inequalities. For a coherent angle system to describe a solution for the circle pattern problem, it has to satisfy in addition certain *non-linear* equations, which guarantee that the triangle figures can be put together to form a circle pattern. It turns out that these non-linear compatibility conditions are the conditions for a critical point of the function $F : \mathbb{R}^{6|T|} \rightarrow \mathbb{R}$ defined below under variations in $\mathcal{A}(\mathcal{T}, \theta, \Xi) \subset \mathbb{R}^{6|T|}$. This is the content of Lemma 1. Together with Lemmas 2 and 3 this provides a proof of Theorem 1.

3.1. The functional. Label $\mathbb{R}^{6|T|}$ as in Section 2.5 and define

$$F_{\mathcal{T}} : \mathbb{R}^{6|T|} \rightarrow \mathbb{R}$$

by

$$F_{\mathcal{T}} = \sum_{t=ijk \in T} V(\alpha_{ij}^t, \alpha_{jk}^t, \alpha_{ki}^t, \gamma_i^t, \gamma_j^t, \gamma_k^t), \quad (8)$$

where

$$\begin{aligned} 2V(\alpha_{12}, \alpha_{23}, \alpha_{31}, \gamma_1, \gamma_2, \gamma_3) = & \\ & \mathbb{J}(\gamma_1) + \mathbb{J}(\gamma_2) + \mathbb{J}(\gamma_3) \\ & + \mathbb{J}\left(\frac{\pi + \alpha_{31} - \alpha_{12} - \gamma_1}{2}\right) + \mathbb{J}\left(\frac{\pi + \alpha_{12} - \alpha_{23} - \gamma_2}{2}\right) + \mathbb{J}\left(\frac{\pi + \alpha_{23} - \alpha_{31} - \gamma_3}{2}\right) \\ & + \mathbb{J}\left(\frac{\pi - \alpha_{31} + \alpha_{12} - \gamma_1}{2}\right) + \mathbb{J}\left(\frac{\pi - \alpha_{12} + \alpha_{23} - \gamma_2}{2}\right) + \mathbb{J}\left(\frac{\pi - \alpha_{23} + \alpha_{31} - \gamma_3}{2}\right) \\ & + \mathbb{J}\left(\frac{\pi + \alpha_{31} + \alpha_{12} - \gamma_1}{2}\right) + \mathbb{J}\left(\frac{\pi + \alpha_{12} + \alpha_{23} - \gamma_2}{2}\right) + \mathbb{J}\left(\frac{\pi + \alpha_{23} + \alpha_{31} - \gamma_3}{2}\right) \\ & + \mathbb{J}\left(\frac{\pi - \alpha_{31} - \alpha_{12} - \gamma_1}{2}\right) + \mathbb{J}\left(\frac{\pi - \alpha_{12} - \alpha_{23} - \gamma_2}{2}\right) + \mathbb{J}\left(\frac{\pi - \alpha_{23} - \alpha_{31} - \gamma_3}{2}\right), \end{aligned} \quad (9)$$

and the function

$$\mathbb{J}(x) = - \int_0^x \log |2 \sin \xi| d\xi$$

is *Milnor’s Lobachevsky function* [22], [24]. (This is up to scale the same as *Clausen’s integral* $\text{Cl}_2(x) = 2\mathbb{J}(\frac{x}{2})$; see Clausen [11], Lewin [20].) The function \mathbb{J} is π -periodic, continuous, and odd. It is smooth everywhere except at integer multiples

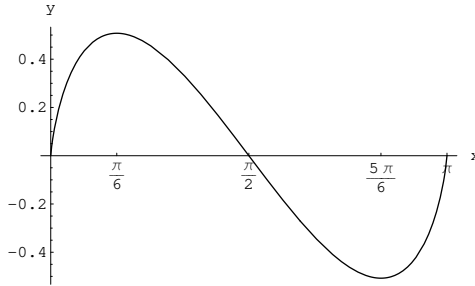

FIGURE 5. Milnor's Lobachevsky function, $y = \mathbb{J}\mathbb{I}(x)$.

of π where its graph has a vertical tangent; see Figure 5. We will simply write F for $F_{\mathcal{T}}$ when the triangulation \mathcal{T} can be inferred from the context.

3.2. The main lemmas. The following three lemmas imply Theorem 1. By Lemma 1, the critical points of F in $\mathcal{A}(\mathcal{T}, \theta, \Xi)$ correspond to the solutions of the circle pattern problem. Lemma 2 implies the uniqueness claim of Theorem 1. The existence claim follows from Lemma 3.

Lemma 1. *A coherent angle system $p \in \mathcal{A}(\mathcal{T}, \theta, \Xi)$ is a critical point of F under variations in $\mathcal{A}(\mathcal{T}, \theta, \Xi)$ if and only if the decorated triangles fit together.*

Lemma 2. *The function F is strictly concave on $\mathcal{A}(\mathcal{T}, \theta, \Xi)$.*

Lemma 3. *If $\mathcal{A}(\mathcal{T}, \theta, \Xi)$ is non-empty, then the restriction of F to the closure $\overline{\mathcal{A}(\mathcal{T}, \theta, \Xi)}$ attains its maximum in $\mathcal{A}(\mathcal{T}, \theta, \Xi)$.*

4. PROOF OF LEMMA 1

The key ingredient to this proof is Schläfli's formula for the derivative of the volume of a hyperbolic polyhedron when it is deformed in such a way that its combinatorial type is preserved; see Milnor [25], [30].

Theorem (Schläfli's differential volume formula). *The differential of the volume function V on the space of 3-dimensional hyperbolic polyhedra of a fixed combinatorial type is*

$$dV = -\frac{1}{2} \sum_{ij} a_{ij} d\alpha_{ij}, \quad (10)$$

where the sum is taken over the edges ij , and a_{ij} , α_i are the length and interior dihedral angle at edge ij .

Hyperbolic polyhedra with some or all vertices on the sphere at infinity still have finite volume. Milnor notes (in the concluding remarks of [25]) that Equation (10) remains true for such polyhedra, under the following modification which is necessary because the edges incident with an ideal vertex are of course infinitely long. Choose arbitrary horospheres centered at the ideal vertices, and for edges ij incident with an ideal vertex let a_{ij} be the length of the edge truncated at the horosphere(s) centered the ideal endpoint(s). One should add that only deformations that leave the ideal vertices on the infinite sphere are considered. The angle sum at an ideal vertex remains constant under such a deformation, so $\sum d\alpha_{ij} = 0$. If one chooses a different horosphere at an ideal vertex i , the resulting truncated edge lengths of the incident edges differ by the same additive constant: α_{ij} becomes $\alpha_{ij} + c_i$. Hence the right hand side of Equation (10) does not depend on the choice of horospheres. A

proof for this extension of Schläfli's differential volume formula to polyhedra with ideal vertices is contained in [33] (Lemma 4.1).

Next we extend Schläfli's differential volume formula to polyhedra that have vertices beyond the sphere at infinity, but all of whose edges still intersect hyperbolic space. If we truncate the hyperideal vertices at the dual hyperbolic planes, we obtain a polyhedron with finite volume. (It may still have ideal vertices.)

Definition. The *truncated volume* of a hyperbolic polyhedron with vertices beyond infinity is the finite volume of the corresponding truncated polyhedron, truncated at the hyperbolic planes dual to the hyperideal vertices.

Equation (10) remains true for polyhedra with hyperideal vertices if we let V be the truncated volume and a_{ij} be the edge lengths truncated at the dual planes of hyperideal vertices and at horospheres centered at ideal vertices. Indeed, if we apply Schläfli's differential volume formula to the truncated polyhedron, the edges introduced by the truncation (those between original faces and truncation planes) have dihedral angle $\pi/2$, and this angle is constant during any deformation. So for these edges $d\alpha_{ij} = 0$. Thus, only terms involving the original edges remain in (10).

Lemma 4. *The truncated volume of the tetrahedron with one ideal and three hyperideal vertices with angles as shown in Figure 4 is equal to $V(\alpha_{12}, \alpha_{23}, \alpha_{31}, \gamma_1, \gamma_2, \gamma_3)$ as defined by Equation (9).*

We prove this lemma in Section 7.

Remark. Exactly the same formula holds for tetrahedra with one ideal and three *finite* vertices [36], [37]. The only difference is that the dihedral angles for such polyhedra satisfy the opposite inequalities instead of (4). This seems to be a common phenomenon: that the same volume formula holds regardless of whether certain vertices are finite or hyperideal. In the case of orthoschemes (the generalization of triply orthogonal tetrahedra to arbitrary dimension) this was observed by Kellerhals [17]. Section 7 contains some more examples. It would obviously be useful to have this observation cast into a theorem. The author is not aware that this has been done.

From Schläfli's differential volume formula and Lemma 4 we obtain the following.

Lemma 5. *If we choose a horosphere centered at the ideal vertex of the truncated hyperbolic tetrahedron shown in Figure 4 then*

$$-2 \frac{\partial V}{\partial \alpha_{ij}} = a_{ij}, \quad (11)$$

where a_{ij} is the length of the edge between the hyperideal vertices i and j truncated at the polar planes, and

$$-2 \left(\frac{\partial V}{\partial \gamma_i} - \frac{\partial V}{\partial \gamma_j} \right) = a_i - a_j, \quad (12)$$

where a_i is the length of the edge from the ideal vertex to the hyperideal vertex i , truncated at the horosphere and the dual plane.

Equations (11) and (12) provide formulas for the edge lengths of the truncated hyperbolic polyhedron in terms of the dihedral angles α_{ij} and γ_i . Because the choice of the truncating horosphere at the ideal vertex is arbitrary, the lengths a_i are only determined up to an additive constant.

The hyperbolic lengths a_{ij} and a_i are related to the euclidean lengths l_{ij} and the radii r_i (see Figure 3). The radii r_i are proportional to e^{-a_i} , *i.e.*

$$\frac{r_i}{r_j} = e^{-a_i + a_j}, \quad (13)$$

and

$$l_{ij}^2 = r_1^2 + r_2^2 + 2r_1r_2 \cosh a_{12}. \quad (14)$$

(These relations are obtained by straightforward calculation in the Poincaré half-space model. The quantity $\cosh a_{12}$ is the *inversive distance* of two circles in the plane.) Together, Equations (11)–(14) provide formulas for the radii r_i and the euclidean edge lengths l_{ij} in terms of the angles α_{ij} and γ_i . They determine the r_i and l_{ij} up to a common factor, in agreement with the fact that the angles determine the decorated triangle of Figure 3 up to similarity.

Now let $(\alpha, \gamma) \in \mathcal{A}(\mathcal{T}, \theta, \Xi)$ be a coherent angle system. For each triangle $t \in T$ the angles $(\alpha_{ij}^t, \alpha_{jk}^t, \alpha_{ki}^t, \gamma_i^t, \gamma_j^t, \gamma_k^t)$ determine a decorated triangle up to similarity. These fit together to form a hyperideal circle pattern iff they can be scaled consistently; this means iff a radius r_i can be assigned to each vertex i and a length l_{ij} to each edge such that the relations (11)–(14) hold for each triangle. Equivalently, the corresponding hyperbolic tetrahedra fit together iff the horospheres at the infinite vertices can be chosen consistently; this means iff an $a_i \in \mathbb{R}$ can be assigned to each vertex i and an $a_{ij} \in \mathbb{R}$ to each edge ij such that the following holds:

If $t \in T$ and $i, j \in t$, then

$$-2 \frac{\partial V}{\partial \alpha_{ij}^t} = a_{ij} \quad (15)$$

and

$$-2 \left(\frac{\partial V}{\partial \gamma_i^t} - \frac{\partial V}{\partial \gamma_j^t} \right) = a_i - a_j, \quad (16)$$

where the derivatives are evaluated at $(\alpha_{ij}^t, \alpha_{jk}^t, \alpha_{ki}^t, \gamma_i^t, \gamma_j^t, \gamma_k^t)$. Now since

$$\frac{\partial V}{\partial \alpha_{ij}^t}(\alpha_{ij}^t, \alpha_{jk}^t, \alpha_{ki}^t, \gamma_i^t, \gamma_j^t, \gamma_k^t) = \frac{\partial F}{\partial \alpha_{ij}^t}(\alpha, \gamma)$$

and

$$\frac{\partial V}{\partial \gamma_i^t}(\alpha_{ij}^t, \alpha_{jk}^t, \alpha_{ki}^t, \gamma_i^t, \gamma_j^t, \gamma_k^t) = \frac{\partial F}{\partial \gamma_i^t}(\alpha, \gamma),$$

(see Equation (8)), Equations (15) and (16) are equivalent to

$$-2 \frac{\partial F}{\partial \alpha_{ij}^t}(\alpha, \gamma) = a_{ij} \quad (17)$$

and

$$-2 \left(\frac{\partial F}{\partial \gamma_i^t}(\alpha, \gamma) - \frac{\partial F}{\partial \gamma_j^t}(\alpha, \gamma) \right) = a_i - a_j. \quad (18)$$

Clearly, the Equations (17) for the a_{ij} are compatible iff the following condition holds:

(i) For each interior edge ij ,

$$\left(\frac{\partial}{\partial \alpha_{ij}^t} - \frac{\partial}{\partial \alpha_{ij}^{t'}} \right) F(\alpha, \gamma) = 0, \quad (19)$$

where t and t' are the triangles adjacent with ij .

Equations (18) for the a_i are compatible iff the condition holds:

(ii) If $i_0 t_1 i_1 t_2 i_3 \dots t_n i_n$ is any finite sequence of alternatingly vertices and triangles that starts and ends with the same vertex $i_0 = i_n$, and that has the property that each t_m contains preceding vertex i_{m-1} and the following vertex i_m , then

$$\sum_{m=1}^n \left(\frac{\partial}{\partial \gamma_{i_m}^{t_m}} - \frac{\partial}{\partial \gamma_{i_{m-1}}^{t_{m-1}}} \right) F(\alpha, \gamma) = 0. \quad (20)$$

These conditions (i) and (ii) are the non-linear compatibility conditions that a coherent has to satisfy to represent a solution to the circle pattern problem. It

remains to show that they are also the conditions for a critical point of F under variations in $\mathcal{A}(\mathcal{T}, \theta, \Xi)$. This is achieved by the following lemma, which concludes the proof of Lemma 1.

Lemma 6. *The tangent space to $\mathcal{A}(\mathcal{T}, \theta, \Xi)$ is spanned by the tangent vectors*

$$\frac{\partial}{\partial \alpha_{ij}^t} - \frac{\partial}{\partial \alpha_{ji}^{t'}} \quad (21)$$

(one for each interior edge) and

$$\sum_{m=1}^n \left(\frac{\partial}{\partial \gamma_m^{t_m}} - \frac{\partial}{\partial \gamma_{m-1}^{t_m}} \right) \quad (22)$$

(one for each cycle $i_0 t_1 i_1 t_2 i_3 \dots t_n i_n$) that appear in conditions (i) and (ii) above.

Proof. The space $\mathcal{A}(\mathcal{T}, \theta, \Xi)$ is defined by strict inequalities and Equations (3), (5), (6), and (7). The equations for a tangent vector are therefore:

- (a) For each boundary edge ij : $d\alpha_{ij}^t = 0$.
- (b) For each interior edge $ij = t \cap t'$: $d\alpha_{ij}^t + d\alpha_{ji}^{t'} = 0$.
- (c) For each vertex i : $\sum_{t \ni i} d\gamma_i^t = 0$.
- (d) For each triangle $t = ijk$: $d\gamma_i^t + d\gamma_j^t + d\gamma_k^t = 0$.

Since each equation involves either alphas or gammas but not both, the tangent space is the direct sum of an α -subspace and a γ -subspace. The α -subspace is clearly spanned by the tangent vectors (21). To see that the γ -subspace is spanned by the vectors (22), let G be the graph with vertex-set $\mathcal{V} = V \cup T$ and edge-set

$$\mathcal{E} = \{ \{i, t\} \in \mathcal{V} \mid i \in V, t \in T, i \in t \}.$$

The edges $\{i, t\}$ of G are in one-to-one correspondence with the tangent vectors $\frac{\partial}{\partial \gamma_i^t}$. This gives rise to a linear isomorphism between the space of edge-chains of G (over \mathbb{R}) and the space spanned by the vectors $\frac{\partial}{\partial \gamma_i^t}$. Equations (c) and (d) are then simply the equations for the cycle-space of G . \square

5. PROOF OF LEMMA 2

We are going to show that each of the terms $V(\alpha_i^t, \alpha_j^t, \alpha_k^t, \gamma_i^t, \gamma_j^t, \gamma_k^t)$ in Equation (8) is concave. To this end, we split the 15-term sum in Equation (9) which defines V into five parts; see Equation (25). Each part represents the volume of an ideal tetrahedron (Theorem 5), which is known to be concave (Lemma 7).

5.1. The volume of an ideal tetrahedron. Consider a hyperbolic tetrahedron with all four vertices on the sphere at infinity. For each vertex the sum of the interior dihedral angles at the adjacent edges is π . This implies that the angles at opposite edges are equal [22] [24]. An ideal tetrahedron is therefore determined by three angles in the set

$$\Delta_0 = \{ (\gamma_1, \gamma_2, \gamma_3) \in \mathbb{R}^3 \mid \gamma_i > 0, \gamma_1 + \gamma_2 + \gamma_3 = \pi \}. \quad (23)$$

Theorem 5 (Milnor [22] [24]). *The hyperbolic volume of an ideal tetrahedron with dihedral angles $(\gamma_1, \gamma_2, \gamma_3) \in \Delta_0$ is*

$$V_0(\gamma_1, \gamma_2, \gamma_3) = \mathbb{J}\mathbb{I}(\gamma_1) + \mathbb{J}\mathbb{I}(\gamma_2) + \mathbb{J}\mathbb{I}(\gamma_3). \quad (24)$$

Lemma 7 (Rivin [26]). *The volume function V_0 is strictly concave on Δ_0 .*

The proof is straight forward. For the reader's convenience, we repeat it here.

Proof of Lemma 7. Let

$$f(\alpha, \beta) = V_0(\alpha, \beta, \pi - \alpha - \beta) = \mathbb{J}(\alpha) + \mathbb{J}(\beta) - \mathbb{J}(\alpha + \beta)$$

and assume that $\alpha > 0$, $\beta > 0$, $\alpha + \beta < \pi$. Since $\mathbb{J}''(x) = -\cot x$, the Hessian matrix of f is

$$\text{Hess } f = \begin{pmatrix} -\cot \alpha + \cot(\alpha + \beta) & \cot(\alpha + \beta) \\ \cot(\alpha + \beta) & -\cot \beta + \cot(\alpha + \beta) \end{pmatrix}.$$

A short calculation shows that the determinant of $\text{Hess}(f)$ is 1. The matrix is therefore either positive definite or negative definite. But since the cotangent is a strictly decreasing function on $(0, \pi)$, the diagonal elements are negative. Hence $\text{Hess}(f)$ is negative definite and $f(\alpha, \beta)$ is strictly concave. \square

5.2. Five ideal tetrahedra. Equation (9) for the truncated volume $V(\alpha_{12}, \alpha_{23}, \alpha_{31}, \gamma_1, \gamma_2, \gamma_3)$ can be rewritten as

$$2V(T) = \sum_{i=1}^3 (\mathbb{J}(\gamma_i) + \mathbb{J}(\gamma'_i) + \mathbb{J}(\gamma''_i) + \mathbb{J}(\mu_i) + \mathbb{J}(\nu_i)),$$

where

$$\begin{aligned} \gamma'_1 &= \frac{\pi + \alpha_{31} - \alpha_{12} - \gamma_1}{2}, & \gamma'_2 &= \frac{\pi + \alpha_{12} - \alpha_{23} - \gamma_2}{2}, & \gamma'_3 &= \frac{\pi + \alpha_{23} - \alpha_{31} - \gamma_3}{2}, \\ \gamma''_1 &= \frac{\pi - \alpha_{31} + \alpha_{12} - \gamma_1}{2}, & \gamma''_2 &= \frac{\pi - \alpha_{12} + \alpha_{23} - \gamma_2}{2}, & \gamma''_3 &= \frac{\pi - \alpha_{23} + \alpha_{31} - \gamma_3}{2}, \\ \mu_1 &= \frac{\pi + \alpha_{31} + \alpha_{12} - \gamma_1}{2}, & \mu_2 &= \frac{\pi + \alpha_{12} + \alpha_{23} - \gamma_2}{2}, & \mu_3 &= \frac{\pi + \alpha_{23} + \alpha_{31} - \gamma_3}{2}, \\ \nu_1 &= \frac{\pi - \alpha_{31} - \alpha_{12} - \gamma_1}{2}, & \nu_2 &= \frac{\pi - \alpha_{12} - \alpha_{23} - \gamma_2}{2}, & \nu_3 &= \frac{\pi - \alpha_{23} - \alpha_{31} - \gamma_3}{2}. \end{aligned}$$

The following observation is both very simple and crucial for this proof (and also for the proof of Lemma 3 in Section 6): If

$$(\alpha_{12}, \alpha_{23}, \alpha_{31}, \gamma_1, \gamma_2, \gamma_3) \in \Delta,$$

then

$$(\gamma'_1, \gamma'_2, \gamma'_3) \in \Delta_0, \quad (\gamma''_1, \gamma''_2, \gamma''_3) \in \Delta_0$$

and also

$$(\gamma_1, \mu_1, \nu_1) \in \Delta_0, \quad (\gamma_2, \mu_2, \nu_2) \in \Delta_0, \quad (\gamma_3, \mu_3, \nu_3) \in \Delta_0.$$

Thus, $2V$ is the sum of the volumes of five ideal tetrahedra:

$$\begin{aligned} 2V(\alpha_{12}, \alpha_{23}, \alpha_{31}, \gamma_1, \gamma_2, \gamma_3) &= V_0(\gamma'_1, \gamma'_2, \gamma'_3) + V_0(\gamma''_1, \gamma''_2, \gamma''_3) \\ &\quad + V_0(\gamma_1, \mu_1, \nu_1) + V_0(\gamma_2, \mu_2, \nu_2) + V_0(\gamma_3, \mu_3, \nu_3). \end{aligned} \quad (25)$$

Since each of the five terms is concave by Lemma 7, $2V$ is concave and so is F . This completes the proof of Lemma 2.

Remark. We have no geometric explanation why $2V$ is the sum of the volumes of five ideal tetrahedra, although this may well be a consequence of Doyle & Leibon's "23040 symmetries of hyperbolic tetrahedra" [14]. Equation (25) is not the only way to write $2V$ as a sum of five tetrahedra: For example, because $(\alpha_1, \alpha_2, \alpha_3, \gamma_1, \gamma_2, \gamma_3) \in \Delta$ also implies

$$(\gamma_1, \gamma_2, \gamma_3) \in \Delta_0, \quad (\gamma'_1, \mu_2, \nu_3) \in \Delta_0, \quad (\gamma'_2, \mu_3, \nu_1) \in \Delta_0, \quad (\gamma'_3, \mu_1, \nu_2) \in \Delta_0,$$

one has as well

$$\begin{aligned} 2V(\alpha_{12}, \alpha_{23}, \alpha_{31}, \gamma_1, \gamma_2, \gamma_3) &= V_0(\gamma_1, \gamma_2, \gamma_3) + V_0(\gamma''_1, \gamma''_2, \gamma''_3) \\ &\quad + V_0(\gamma'_1, \mu_2, \nu_3) + V_0(\gamma'_2, \mu_3, \nu_1) + V_0(\gamma'_3, \mu_1, \nu_2). \end{aligned}$$

6. PROOF OF LEMMA 3

To prove Lemma 3 we have to show the following:

Claim. *Suppose $\mathcal{A}(\mathcal{T}, \theta, \Xi) \neq \emptyset$ and let $p \in \overline{\mathcal{A}(\mathcal{T}, \theta, \Xi)} \setminus \mathcal{A}(\mathcal{T}, \theta, \Xi)$. Then there is a $q \in \mathcal{A}(\mathcal{T}, \theta, \Xi)$ with $F(q) > F(p)$.*

In the following Section, we will analyze the behavior of the volume function V as the dihedral angles approach the relative boundary of the domain. In Section 6.2 we will use this analysis to prove the Claim.

6.1. Behavior of the volume function at the boundary of the domain. We will first recollect Rivin's analysis [26] of the behavior of the volume $V_0(p)$ of an ideal tetrahedron (see Section 5.1) as p approaches the relative boundary $\overline{\Delta_0} \setminus \Delta_0$ of the domain Δ_0 . Then we will use this for the corresponding analysis of the volume function V of a tetrahedron with one ideal and three hyperideal vertices. Here we will again make essential use of the decomposition into five ideal tetrahedra described in Section 5.2.

Boundary behavior of V_0 . First consider the set Δ_0 of dihedral angles of ideal tetrahedra (see Equation (23) in Section 5.1). Its closure $\overline{\Delta_0}$ is the 2-simplex in \mathbb{R}^3 that is spanned by the points $(\pi, 0, 0)$, $(0, \pi, 0)$, $(0, 0, \pi)$. The points in the relative boundary $\overline{\Delta_0} \setminus \Delta_0$ correspond to ideal tetrahedra that have degenerated to planar figures.

Definition. We call a point $(\gamma_1, \gamma_2, \gamma_3) \in \overline{\Delta_0} \setminus \Delta_0$ *mildly degenerate* iff $(\gamma_1, \gamma_2, \gamma_3)$ is some permutation of $(0, \beta, \pi - \beta)$ with $0 < \beta < \pi$, *i.e.* iff p is contained in an open side of the boundary triangle. We call it *badly degenerate* iff $(\gamma_1, \gamma_2, \gamma_3)$ is some permutation of $(0, 0, \pi)$, *i.e.* iff it is a vertex of the boundary triangle.

It is easy to see that V_0 vanishes on $\overline{\Delta_0} \setminus \Delta_0$. But the speed with which $V(q)$ tends to 0 as $q \in \Delta_0$ approaches the boundary is different depending on whether q approaches a mildly or a badly degenerate point:

Lemma 8. *Let $p \in \overline{\Delta_0} \setminus \Delta_0$, $q \in \Delta_0$. If p is mildly degenerate, then*

$$\lim_{t \searrow 0} \frac{d}{dt} V_0((1-t)p + tq) = +\infty. \quad (26)$$

If p is badly degenerate then the t -derivative

$$\frac{d}{dt} V_0((1-t)p + tq) \quad (27)$$

has a finite positive limit for $t \searrow 0$.

Proof. The claim for mildly degenerate p follows directly from the fact that $\mathbb{J}(x)$ is smooth except at integer multiples of π , where the derivative $\mathbb{J}'(x) = -\log |2 \sin x|$ tends to $+\infty$. To prove the claim for badly degenerate p , let us assume without loss of generality that $p = (0, 0, \pi)$. Then

$$(1-t)p + tq = (ta, tb, \pi - t(a+b))$$

for some $a, b > 0$, and

$$V_0((1-t)p + tq) = \mathbb{J}(ta) + \mathbb{J}(tb) - \mathbb{J}(t(a+b)).$$

Hence for the t -derivative we obtain

$$\frac{d}{dt} V_0((1-t)p + tq) = \log \left| \frac{\sin^{a+b}(t(a+b))}{\sin^a(ta) \sin^b(tb)} \right| \xrightarrow{t \searrow 0} \log \frac{(a+b)^{a+b}}{a^a b^b} > 0.$$

□

Boundary behavior of V . Now consider the set Δ of dihedral angles of tetrahedra with one ideal and three hyperideal vertices (see Section 2.4). Its closure $\overline{\Delta}$ is the set of points $(\alpha_{12}, \alpha_{23}, \alpha_{31}, \gamma_1, \gamma_2, \gamma_3) \in \mathbb{R}^6$ that satisfy Equation (3) and the non-strict versions of the inequalities (2) and (4). A point is in the relative boundary $\overline{\Delta} \setminus \Delta$ if it satisfies with equality at least one of these the non-strict inequalities. In Section 5.2 we described an affine map $\Delta \rightarrow (\Delta_0)^5$ associating five ideal tetrahedra with each point in Δ . This extends to a map $\overline{\Delta} \rightarrow (\overline{\Delta}_0)^5$. We classify the degenerate points $p \in \overline{\Delta} \setminus \Delta$ according to whether any of the five corresponding ideal tetrahedra degenerate and the way in which they do:

Definition. Let $p \in \overline{\Delta} \setminus \Delta$. We say that p is *mildly degenerate* iff at least one of the five corresponding ideal tetrahedra is mildly degenerate. We say that p is *badly degenerate* iff at least one of the five ideal tetrahedra is badly degenerate but none are mildly degenerate. We say that p is *α -degenerate* iff all five corresponding ideal tetrahedra are non-degenerate.

Clearly, every $p \in \overline{\Delta} \setminus \Delta$ is either mildly degenerate, badly degenerate or α -degenerate. By Lemma 10, there is only one badly degenerate p up to a permutation of the indices. The reason for calling the last type “ α -degenerate” will be made clear by Lemma 11. The next lemma follows immediately from Lemma 8.

Lemma 9. *Let $p \in \overline{\Delta} \setminus \Delta$, $q \in \Delta$. If p is mildly degenerate, then*

$$\lim_{t \searrow 0} \frac{d}{dt} V((1-t)p + tq) = +\infty. \quad (28)$$

If p is badly degenerate or α -degenerate then the t -derivative

$$\frac{d}{dt} V((1-t)p + tq) \quad (29)$$

has a finite limit for $t \searrow 0$.

Lemma 10. *Suppose $(\alpha_{12}, \alpha_{23}, \alpha_{31}, \gamma_1, \gamma_2, \gamma_3) \in \overline{\Delta} \setminus \Delta$ is badly degenerate. Then*

$$\gamma_i = \alpha_{jk} = \pi, \quad \gamma_j = \gamma_k = \alpha_{ij} = \alpha_{ki} = 0$$

for some permutation (i, j, k) of $(1, 2, 3)$. (This implies that all five corresponding ideal tetrahedra are badly degenerate.)

Proof. We consider separately all essentially different cases of one of the five ideal tetrahedra badly degenerating in some way, where we consider cases as essentially different if they do not only differ by a permutation of the indices. First, note that by summing (the non-strict versions of) the inequalities (4) and using Equation (3), one obtains

$$\alpha_{12} + \alpha_{23} + \alpha_{31} \leq \pi.$$

Case 1: $(\gamma'_1, \gamma'_2, \gamma'_3) = (0, 0, \pi)$. Since

$$\pi = 2\gamma'_3 - \pi = \alpha_{23} - \alpha_{31} - \gamma_3,$$

we have $\alpha_{23} = \pi$ and hence $\alpha_{12} = \alpha_{31} = \gamma_2 = \gamma_3 = 0$ and $\gamma_1 = \pi$.

Case 2: $(\gamma_1, \mu_1, \nu_1) = (\pi, 0, 0)$. First, $\gamma_1 = \pi$ implies $\gamma_2 = \gamma_3 = \alpha_{12} = \alpha_{31} = 0$. Then

$$(\gamma'_1, \gamma'_2, \gamma'_3) = \left(0, \frac{\pi - \alpha_{23}}{2}, \frac{\pi + \alpha_{23}}{2}\right),$$

and since by assumption this is not mildly degenerate, we have $\alpha_{23} = \pi$.

Case 3: $(\gamma_1, \mu_1, \nu_1) = (0, \pi, 0)$. First, $\gamma_1 = 0$ implies $\gamma_2 + \gamma_3 + \pi; \mu_1 = \pi$ implies $\alpha_{31} + \alpha_{12} = \pi$ and hence $\alpha_{23} = 0$. Now the non-strict versions of the inequalities (4) imply $\alpha_{12} + \gamma_2 = \pi$ and $\alpha_{31} + \gamma_3 = \pi$. Hence $\nu_2 = \nu_3 = 0$. Since by assumption, neither (γ_2, μ_2, ν_2) nor (γ_3, μ_3, ν_3) are mildly degenerate, either $\gamma_2 = \alpha_{31} = \pi$ and $\gamma_3 = \alpha_{12} = 0$ or $\gamma_2 = \alpha_{31} = 0$ and $\gamma_3 = \alpha_{12} = \pi$.

(Non-)Case 4: $(\gamma_1, \mu_1, \nu_1) = (0, 0, \pi)$. This cannot happen because $\nu_1 \leq \frac{\pi}{2}$. \square

Lemma 11. *Suppose $p = (\alpha_{12}, \alpha_{23}, \alpha_{31}, \gamma_1, \gamma_2, \gamma_3) \in \overline{\Delta} \setminus \Delta$ is α -degenerate. Then all $\gamma_i > 0$ and the strict inequalities (4) are satisfied, but some α_{ij} vanish.*

Proof. First, $\gamma_i > 0$ and $\gamma_i + \alpha_{ij} + \alpha_{ki} < \pi$ because $\gamma_i = 0$ or $\gamma_i + \alpha_{ij} + \alpha_{ki} = \pi$ would imply that (γ_i, μ_i, ν_i) is degenerate. But then some α_{ij} must vanish because otherwise $p \in \Delta$. \square

6.2. Proof of the Claim. Suppose $\mathcal{A}(\mathcal{T}, \theta, \Xi) \neq \emptyset$ and let $p = (\alpha, \gamma) \in \overline{\mathcal{A}(\mathcal{T}, \theta, \Xi)} \setminus \mathcal{A}(\mathcal{T}, \theta, \Xi)$. We distinguish several cases.

Case 1. *There is at least one triangle $t \in T$ such that (α^t, γ^t) is mildly degenerate.* Let $\tilde{p} = (\tilde{\alpha}, \tilde{\gamma}) \in \mathcal{A}(\mathcal{T}, \theta, \Xi)$ be any coherent angle system. Then Lemma 9 implies

$$\lim_{t \searrow 0} \frac{d}{dt} F((1-t)p + t\tilde{p}) = +\infty.$$

It follows (by the mean value theorem) that if $\varepsilon > 0$ is small enough, then $F(q) > F(p)$ for $q = (1-\varepsilon)p + \varepsilon\tilde{p}$. This completes the proof of the Claim under the assumption of Case 1.

Case 2. *There are no $t \in T$ with (α^t, γ^t) mildly degenerate or α -degenerate.* This means all degenerate (α^t, γ^t) are badly degenerate. We will construct a $\tilde{p} \in \overline{\mathcal{A}(\mathcal{T}, \theta, \Xi)} \setminus \mathcal{A}(\mathcal{T}, \theta, \Xi)$ which satisfies $F(p) = F(\tilde{p})$ and the conditions of Case 1. Since the Claim was proven for Case 1, it holds in Case 2 also.

Suppose $t_1 \in T$ with $(\alpha^{t_1}, \gamma^{t_1})$ badly degenerate. Let ij be the edge of t_1 with $\alpha_{ij}^{t_1} = \pi$. Equations (5) and (6) imply that $\theta_{ij} = 0$ and therefore that edge ij is not a boundary edge. Let $t_2 \in T$ be the triangle neighboring t_1 across edge ij . Again by Equation (5), $\alpha_{ji}^{t_2} = 0$, so t_2 is also badly degenerate. By repeating this argument we construct a sequence t_1, t_2, t_3, \dots of badly degenerate triangles, each one adjacent to the next. Since there are only finitely many triangles, this sequence must eventually loop back on itself. Let us reindex the triangles such that $t_1, t_2, \dots, t_n = t_1$ is such a loop of badly degenerate triangles. Define an angle system $\tilde{p} = (\tilde{\alpha}, \tilde{\gamma})$ as follows (see Figure 6). If $t \in T$ is not contained in the loop of triangles, then let $(\tilde{\alpha}^t, \tilde{\gamma}^t) = (\alpha^t, \gamma^t)$. If $t = t_m$ is contained in the loop, let $ij = t_m \cap t_{m+1}$ and $jk = t_{m-1} \cap t_m$, hence

$$\alpha_{ij}^t = \gamma_k^t = \pi, \quad \alpha_{jk}^t = \alpha_{ki}^t = \gamma_i = \gamma_j = 0.$$

Let

$$\begin{aligned} \tilde{\alpha}_{ij}^t &= \tilde{\gamma}_k^t = \pi - \varepsilon, \\ \tilde{\alpha}_{jk}^t &= \tilde{\gamma}_i = \varepsilon, \\ \tilde{\alpha}_{ki}^t &= \tilde{\gamma}_j = 0, \end{aligned}$$

with $\varepsilon \in (0, \pi)$ arbitrary but the same for all triangles in the loop. We claim that $\tilde{p} \in \overline{\mathcal{A}(\mathcal{T}, \theta, \Xi)} \setminus \mathcal{A}(\mathcal{T}, \theta, \Xi)$. Indeed, the triangles in the loop are still in $\overline{\Delta} \setminus \Delta$, but now they are mildly degenerate instead of badly degenerate. Further, the sum of α -angles at edges has obviously not changed, so Equation (5) still holds. Finally, to see that the sum of γ -angles around each vertex has not changed, note that at a vertex i this angle sum is increased by ε for each time that the loop of triangles enters the star of i and is decreased by ε each time it leaves the star. So Equation (7) still holds. Also $F(p) = F(\tilde{p})$, because the truncated volumes for the triangles in the loop are 0 before and after the deformation. Hence we have reduced Case 2 to Case 1.

Case 3. *There are no $t \in T$ with (α^t, γ^t) mildly degenerate, but there is at least one $t \in T$ such that (α^t, γ^t) is α -degenerate.* Suppose $t = ijk \in T$ is α -degenerate and

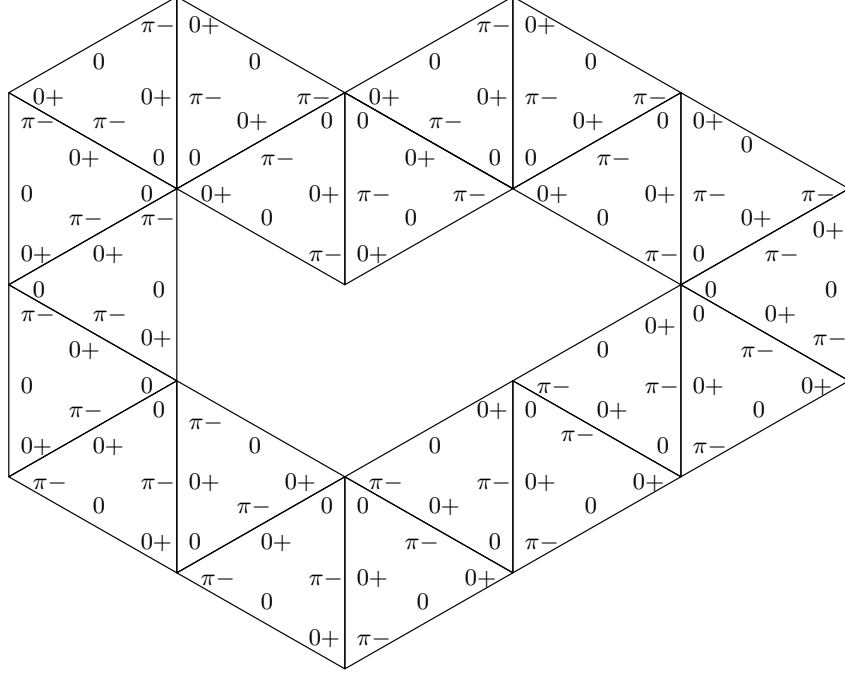

FIGURE 6. How to modify the angles along a loop of badly degenerate triangles. We write $\pi-$ and $0+$ as shorthand for “ π is replaced by $\pi - \varepsilon$ ” and for “ 0 is replaced by ε ”, respectively. The changes in α -angles are indicated along the edges, the changes in γ -angles are indicated in the corners of each triangle.

$\alpha_{ij}^t = 0$. Let $t' = jil$ be the triangle on the other side of edge ij . Note that $\alpha_{ji}^{t'}$ cannot vanish, because this would imply $\theta_{ij} = \pi - \alpha_{ij}^t - \alpha_{ji}^{t'} = \pi$. We distinguish two sub-cases.

Case 3(a). t' is not badly degenerate. Then $0 < \alpha_{ji}^{t'} < \pi$, and we can change the angle system p to the angle system \tilde{p} by setting $\tilde{\alpha}_{ij}^t = \varepsilon$ and $\tilde{\alpha}_{ji}^{t'} = \alpha_{ji}^{t'} - \varepsilon$ for some small $\varepsilon > 0$, and keeping all other angles the same. We claim that $F(\tilde{p}) > F(p)$ if ε is small enough. Indeed,

$$\frac{\partial}{\partial \alpha_{ij}^t} V(\alpha^t, \gamma^t) = 0,$$

because $V(\alpha^t, \gamma^t)$ is even in the α -variables (see Equation (9)), and

$$\frac{\partial}{\partial \alpha_{ji}^{t'}} V(\alpha^{t'}, \gamma^{t'}) = -\frac{1}{2} a_{ji}^{t'} < 0,$$

where $a_{ji}^{t'}$ is the length of the corresponding truncated edge (Lemma 5), which is positive because $a_{ji} = 0$ only if $\alpha_{ji} = 0$ (see Equation (14) and Figure 3). So provided that $\varepsilon > 0$ is small enough, $V(\alpha^t, \gamma^t) + V(\alpha^{t'}, \gamma^{t'})$ increases if α_{ij}^t increases by ε and $\alpha_{ji}^{t'}$ decreases by ε . We have thus constructed a $\tilde{p} \in \overline{\mathcal{A}(\mathcal{T}, \theta, \Xi)}$ without mildly degenerated triangles such that $F(\tilde{p}) > F(p)$ and the number of vanishing α -angles has decreased by one. The Claim follows by induction on the number of vanishing α -angles.

Case 3(b). t' is badly degenerate We will construct a $q \in \mathcal{A}(\mathcal{T}, \theta, \Xi)$ such that $F(q) > F(p)$, but the construction is less straightforward than in the other cases. Note that in this case, $\alpha_{ji}^{t'} = \pi$ and hence $\theta_{ij} = 0$. This means that the solution of

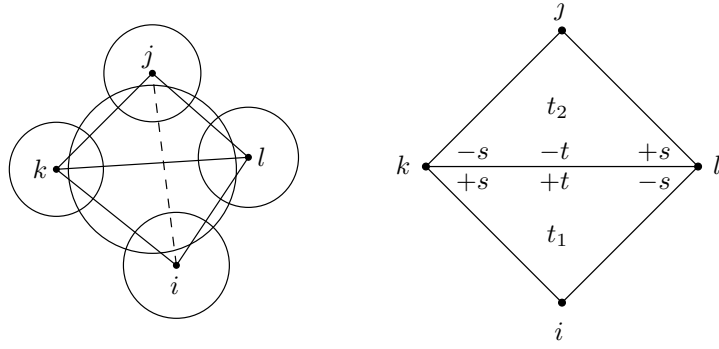

FIGURE 7. *Left*: If neighboring triangles share the same orthogonally intersecting circle, we can perform an edge flip. *Right*: How $\tilde{q}(s, t)$ differs from \tilde{q} .

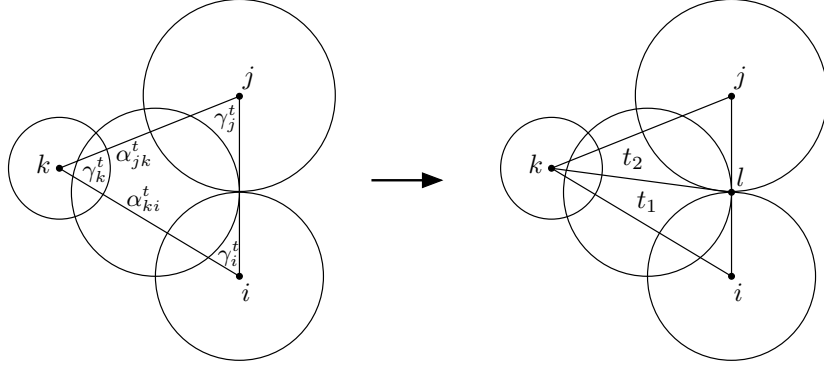

FIGURE 8. The α -degenerate tetrahedron $t = (ijk)$ with $\alpha_{ij}^t = 0$ is split into two triangles $t_1 = (ilk)$, $t_2 = (jkl)$.

the circle pattern problem (if it exists) is such that the same face-circle corresponds to both triangles t and t' ; see Figure 7 (left). Equivalently, the tetrahedra corresponding to these triangles fit together to form a pyramid over a quadrilateral base. Thus, one could pose an equivalent circle pattern problem using the triangulation \tilde{T} that is obtained by flipping the edge ij . This is the basic motivating idea behind the construction we will now describe.

First, we split the α -degenerate tetrahedron (α^t, γ^t) into two tetrahedra $(\alpha^{t_1}, \gamma^{t_1})$ and $(\alpha^{t_2}, \gamma^{t_2})$ as shown in Figure 8. This introduces new angles $\gamma_k^{t_1}, \gamma_l^{t_1}, \gamma_k^{t_2}, \gamma_l^{t_2}, \alpha_{lk}^{t_1}, \alpha_{kl}^{t_2}$, which are uniquely determined by the old angles (α^t, γ^t) . They clearly satisfy

$$\gamma_k^{t_1} + \gamma_k^{t_2} = \gamma_k^t, \quad \gamma_l^{t_1} + \gamma_l^{t_2} = \pi, \quad \alpha_{lk}^{t_1} + \alpha_{kl}^{t_2} = \pi,$$

and also

$$\gamma_l^{t_1} + \alpha_{lk}^{t_1} = \pi, \quad \gamma_l^{t_2} + \alpha_{kl}^{t_2} = \pi.$$

The remaining angles in $(\alpha^{t_1}, \gamma^{t_1})$ and $(\alpha^{t_2}, \gamma^{t_2})$ are equal to the corresponding angles in (α^t, γ^t) :

$$\gamma_i^{t_1} = \gamma_i^t, \quad \gamma_j^{t_2} = \gamma_j^t, \quad \alpha_{ki}^{t_1} = \alpha_{ki}^t, \quad \alpha_{jk}^{t_2} = \alpha_{jk}^t, \quad \alpha_{il}^{t_1} = \alpha_{lj}^{t_2} = \alpha_{ij}^t = 0.$$

The volumes satisfy

$$V(\alpha^t, \gamma^t) = V(\alpha^{t_1}, \gamma^{t_1}) + V(\alpha^{t_2}, \gamma^{t_2}). \quad (30)$$

The tetrahedra $(\alpha^{t_1}, \gamma^{t_1})$ and $(\alpha^{t_2}, \gamma^{t_2})$ are mildly degenerate, because they are not badly degenerate but

$$\gamma_l^{t_1} + \alpha_{ik}^{t_1} + \alpha_{il}^{t_1} = \pi, \quad \gamma_l^{t_2} + \alpha_{ij}^{t_2} + \alpha_{kl}^{t_2} = \pi.$$

Now let $\tilde{\mathcal{T}}$ be the triangulation obtained from \mathcal{T} by flipping the edge ij , thus replacing it with an edge kl and replacing the triangles t, t' with triangles t_1, t_2 . (This edge flip can be performed even if the triangulation \mathcal{T} is not regular. The only obstruction for an edge to be flippable is that it is adjacent to the same triangle on either side. But this is not the case here, because (α^t, γ^t) is α -degenerate, whereas $(\alpha^{t'}, \gamma^{t'})$ is badly degenerate.) Let \tilde{p} be the angle system with $(\alpha^{t_1}, \gamma^{t_1}), (\alpha^{t_2}, \gamma^{t_2})$ as described above and all other angles the same as in p . Then

$$\tilde{p} \in \overline{\mathcal{A}(\tilde{\mathcal{T}}, \tilde{\theta}, \Xi)},$$

where $\tilde{\theta}_{mn} = \theta_{mn}$ for all edges mn of $\tilde{\mathcal{T}}$ except for kl and $\tilde{\theta}_{kl} = \theta_{ij} = 0$. Because of Equation (30) and because the volume of the badly degenerate tetrahedron $(\alpha^{t'}, \gamma^{t'})$ vanishes, we have $F_{\mathcal{T}}(p) = F_{\tilde{\mathcal{T}}}(\tilde{p})$. Now $\mathcal{A}(\tilde{\mathcal{T}}, \tilde{\theta}, \Xi) \neq \emptyset$ because from every coherent angle system in $\mathcal{A}(\mathcal{T}, \theta, \Xi)$ one can easily construct a coherent angle system in $\mathcal{A}(\tilde{\mathcal{T}}, \tilde{\theta}, \Xi)$. Hence the reasoning of Case 1 above applies and there exists a

$$\tilde{q} = (\tilde{\alpha}, \tilde{\gamma}) \in \mathcal{A}(\tilde{\mathcal{T}}, \tilde{\theta}, \Xi) \quad \text{with} \quad F_{\tilde{\mathcal{T}}}(\tilde{q}) > F_{\tilde{\mathcal{T}}}(\tilde{p}) = F_{\mathcal{T}}(p).$$

It remains to construct a $q \in \mathcal{A}(\mathcal{T}, \theta, \Xi)$ with $F_{\mathcal{T}}(q) \geq F_{\tilde{\mathcal{T}}}(\tilde{q})$. If the tetrahedra $(\tilde{\alpha}^{t_1}, \tilde{\gamma}^{t_1})$ and $(\tilde{\alpha}^{t_2}, \tilde{\gamma}^{t_2})$ fit together, this could be achieved by performing another edge flip as in Figure 7 (left). However, they will in general not fit together. We will therefore deform \tilde{q} to obtain a $\tilde{\tilde{q}} \in \mathcal{A}(\tilde{\mathcal{T}}, \tilde{\theta}, \Xi)$ such that the triangles fit together and $F_{\tilde{\mathcal{T}}}(\tilde{\tilde{q}}) \geq F_{\tilde{\mathcal{T}}}(\tilde{q})$. To this end, let $\tilde{q}(s, t)$ be the angle system with

$$\begin{aligned} \tilde{\gamma}_k^{t_1}(s, t) &= \tilde{\gamma}_k^{t_1} + s, & \tilde{\gamma}_l^{t_1}(s, t) &= \tilde{\gamma}_l^{t_1} - s, \\ \tilde{\gamma}_k^{t_2}(s, t) &= \tilde{\gamma}_k^{t_2} - s, & \tilde{\gamma}_l^{t_2}(s, t) &= \tilde{\gamma}_l^{t_2} + s, \\ \tilde{\alpha}_{lk}^{t_1}(s, t) &= \tilde{\alpha}_{lk}^{t_1} + t, & \tilde{\alpha}_{kl}^{t_2}(s, t) &= \tilde{\alpha}_{kl}^{t_2} - t, \end{aligned}$$

and all other angles the same as in \tilde{q} ; see Figure 7 (right). Let

$$U = \{(s, t) \in \mathbb{R}^2 \mid \tilde{q}(s, t) \in \mathcal{A}(\tilde{\mathcal{T}}, \tilde{\theta}, \Xi)\}.$$

This is a bounded open subset of \mathbb{R}^2 . Let $f(s, t) = F_{\tilde{\mathcal{T}}}(\tilde{q}(s, t))$. For $(s_0, t_0) \in U$, the two tetrahedra $(\tilde{\alpha}^{t_1}(s_0, t_0), \tilde{\gamma}^{t_1}(s_0, t_0))$ and $(\tilde{\alpha}^{t_2}(s_0, t_0), \tilde{\gamma}^{t_2}(s_0, t_0))$ fit together iff (s_0, t_0) is a critical point of $f(s, t)$. To see this, apply the same reasoning that was used to prove Lemma 1 in Section 4. Also, $f(s, t)$ is strictly concave on U , because it is a restriction of the strictly concave function $F_{\tilde{\mathcal{T}}}$ (Lemma 2) to an affine subspace. Finally, the maximum of $f(s, t)$ on the compact set \overline{U} cannot be attained on the boundary ∂U . To see this, apply the same reasoning that was used in Case 1 and in Case 3(a) above. (The tetrahedra $(\tilde{\alpha}^{t_1}(s, t), \tilde{\gamma}^{t_1}(s, t))$ and $(\tilde{\alpha}^{t_2}(s, t), \tilde{\gamma}^{t_2}(s, t))$ cannot degenerate badly for $(s, t) \in \overline{U}$.) Hence the restriction of $f(s, t)$ to \overline{U} attains its maximum at some $(s_m, t_m) \in U$, and we have found $\tilde{\tilde{q}} = \tilde{q}(s_m, t_m)$. Finally we obtain $q \in \mathcal{A}(\mathcal{T}, \theta, \Xi)$ with $F_{\mathcal{T}}(q) = F_{\tilde{\mathcal{T}}}(\tilde{\tilde{q}}) > F_{\mathcal{T}}(p)$ from $\tilde{\tilde{q}}$ by flipping the edge kl .

Since we have thus dealt with the last Case, this completes the proof of the Claim, and hence the proof of Lemma 3.

7. VOLUME COMPUTATIONS. PROOF OF LEMMA 4

In this section we derive Equation (9) for the volume of a tetrahedron with one ideal and three hyperideal vertices, that is, we prove Lemma 4 of Section 4. Vinberg [36] [37] derived a formula—in fact, the same formula—for the volume of a tetrahedron

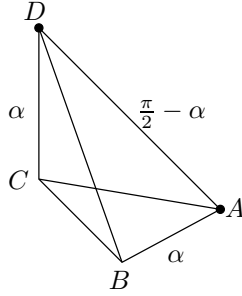

FIGURE 9. The bi-rectangular tetrahedron P_1 with two ideal vertices A and D . The dihedral angles at the unlabeled edges are $\frac{\pi}{2}$.

with one ideal and three *finite* vertices. Here we follow a very similar path. We subdivide a tetrahedron with one ideal and three hyperideal vertices into three special pyramids (Section 7.5). A volume formula for these is derived in Section 7.4 with the help of yet other volume formulas that we present in the following sections.

7.1. The volume of a bi-rectangular tetrahedron with two ideal vertices.

A tetrahedron with vertices $ABCD$ is called *bi-rectangular* or an *orthoscheme* if the edge AB is perpendicular on the side BCD and the edge CD is perpendicular on the side ABC . Then the dihedral angles at edges AC , BD , and BC are $\frac{\pi}{2}$. A formula for the volume of a bi-rectangular hyperbolic tetrahedron as a function of the remaining three dihedral angles was already derived by Lobachevsky [21], see also Coxeter [13]. We are only interested in the case of a bi-rectangular tetrahedron P_1 whose vertices A and D are ideal (see Figure 9). Because the dihedral angles sum to π at the ideal vertices it follows that the angles at AB and CD are equal, say, to α , and the angle at AD is $\frac{\pi}{2} - \alpha$. Milnor derived the particularly simple volume formula

$$\text{Vol}(P_1) = \frac{1}{2} \mathcal{I}(\alpha) \quad (31)$$

by direct integration [22] [24].

7.2. The volume of an ideal prism. Let P_2 be a triangular prism with all vertices at infinity. Such a prism is always symmetric with respect to a planar reflection that interchanges the triangular faces. (This is so because any three points on S^2 , the sphere at infinity, can be mapped to any other three points on S^2 by an orientation reversing Möbius transformation of S^2 , and such a transformation is the restriction of a hyperbolic reflection.) Formula (32) below for the volume of P is derived in [19]. For the reader's convenience we reproduce the argument. Let the interior dihedral angles be $\alpha, \beta, \gamma, \alpha', \beta', \gamma'$, as shown in Figure 10 (left). The symmetry plane intersects the side faces of the prism orthogonally in the dashed triangle. Hence there exists an ideal prism with dihedral angles α, β, γ , iff there is a hyperbolic triangle with these angles, *i.e.* iff

$$\alpha + \beta + \gamma < \pi.$$

The dihedral angles sum to π at each ideal vertex, hence

$$\gamma' = \frac{\pi - \alpha - \beta + \gamma}{2}, \quad \alpha' = \frac{\pi + \alpha - \beta - \gamma}{2}, \quad \beta' = \frac{\pi - \alpha + \beta - \gamma}{2}.$$

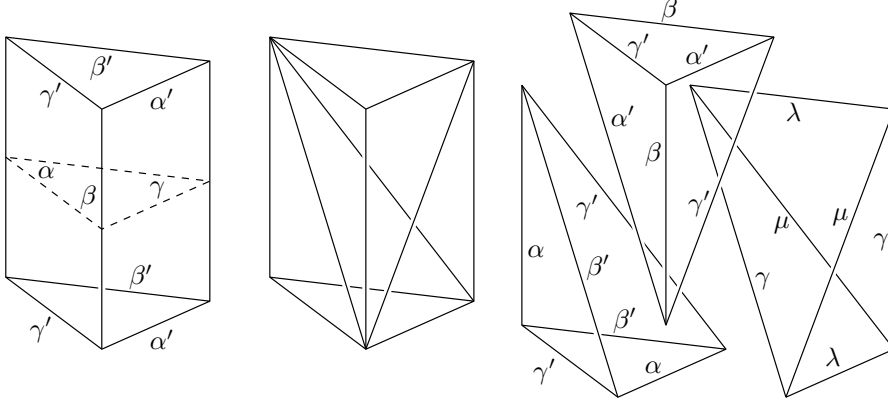

FIGURE 10. The ideal prism P_2 . To calculate its volume, we subdivide it into three ideal tetrahedra.

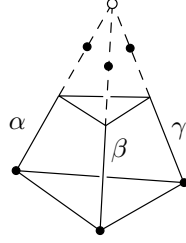

FIGURE 11. The tetrahedron P_3 with one hyperideal vertex (marked \circ) and three ideal vertices. The points where the edges intersect the sphere at infinity are marked \bullet . The tetrahedron is truncated at the polar plane of the hyperideal vertex.

Lemma 12 (Leibon [19]). *The volume of the prism P_2 is*

$$\begin{aligned} \text{Vol}(P_2) &= \mathbb{I}(\alpha) + \mathbb{I}(\beta) + \mathbb{I}(\gamma) \\ &+ \mathbb{I}\left(\frac{\pi + \alpha - \beta - \gamma}{2}\right) + \mathbb{I}\left(\frac{\pi - \alpha + \beta - \gamma}{2}\right) \\ &+ \mathbb{I}\left(\frac{\pi - \alpha - \beta + \gamma}{2}\right) + \mathbb{I}\left(\frac{\pi - \alpha - \beta - \gamma}{2}\right). \end{aligned} \quad (32)$$

Proof. Subdivide the the prism P_2 into three ideal tetrahedra as shown in Figure 10 (middle, right). Since in an ideal tetrahedron the dihedral angles at opposite edges are equal [22] [24], most of the dihedral angles of the three tetrahedra are equal to some angle of the prism; see Figure 10 (right). The remaining two dihedral angles, λ and μ , are obtained by considering how the angles of the prism are sums of angles of the tetrahedra:

$$\lambda = \beta' - \beta = \frac{\pi - \alpha - \beta - \gamma}{2}, \quad \mu = \pi - \gamma'.$$

Now the volumes of the three tetrahedra are obtained from Equation (24). Take the sum and note that $\mathbb{I}(\pi - x) = -\mathbb{I}(x)$ to obtain Equation (32). \square

7.3. The truncated volume of a tetrahedron with one hyperideal and three ideal vertices. Let P_3 be a tetrahedron with one hyperideal and three ideal vertices as shown in Figure 11.

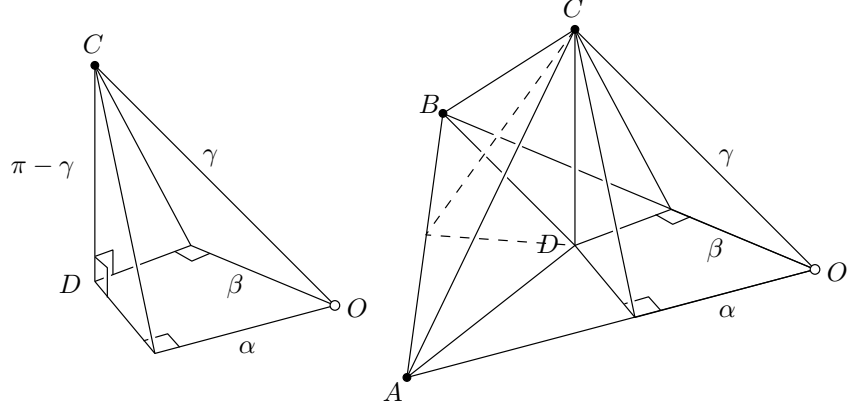

FIGURE 12. The special pyramid P_4 (left). Decomposition of a tetrahedron with one hyperideal and three ideal vertices into one special pyramid and four birectangular tetrahedra, two of which are mirror symmetric to each other (right).

Lemma 13. *The truncated volume (see Definition on p. 12) of P_3 is*

$$\begin{aligned} \text{Vol}(P_3) = \frac{1}{2} & \left(\mathfrak{I}(\alpha) + \mathfrak{I}(\beta) + \mathfrak{I}(\gamma) \right. \\ & + \mathfrak{I}\left(\frac{\pi + \alpha - \beta - \gamma}{2}\right) + \mathfrak{I}\left(\frac{\pi - \alpha + \beta - \gamma}{2}\right) \\ & \left. + \mathfrak{I}\left(\frac{\pi - \alpha - \beta + \gamma}{2}\right) + \mathfrak{I}\left(\frac{\pi - \alpha - \beta - \gamma}{2}\right) \right). \quad (33) \end{aligned}$$

Proof. If you reflect the truncated tetrahedron at the truncation plane, you get an ideal prism. The volume of the truncated tetrahedron is therefore half the volume of the ideal prism, Equation (32). \square

Remark. The same volume formula holds when the apex is finite instead of hyperideal [36] [37]. In that case $\alpha + \beta + \gamma > \pi$.

7.4. The truncated volume of a special pyramid. Let P_4 be a pyramid over a quadrilateral base, such that the apex C is at infinity, one lateral edge CD is perpendicular to the base, the vertex O of the base that is opposite D is hyperideal, and at the other two vertices the angles of the base quadrilateral are $\frac{\pi}{2}$; see Figure 12 (left). Let the interior dihedral angles at the edges emanating from O be α , β , and γ as shown. They satisfy $\alpha, \beta < \pi/2$ and $\alpha + \beta + \gamma < \pi$. Since the sum of dihedral angles at the four-valent apex C is 2π and two of the incident edges have dihedral angle $\frac{\pi}{2}$, the dihedral angle at edge CD is $\pi - \gamma$.

Lemma 14. *The truncated volume of P_4 is*

$$\begin{aligned} V(P_4) = \frac{1}{2} & \left(\mathfrak{I}(\gamma) + \mathfrak{I}\left(\frac{\pi + \alpha - \beta - \gamma}{2}\right) + \mathfrak{I}\left(\frac{\pi - \alpha + \beta - \gamma}{2}\right) \right. \\ & \left. - \mathfrak{I}\left(\frac{\pi - \alpha - \beta + \gamma}{2}\right) + \mathfrak{I}\left(\frac{\pi - \alpha - \beta - \gamma}{2}\right) \right). \quad (34) \end{aligned}$$

Proof. Extend the edges of the base emanating from O until they intersect the infinite boundary at the ideal points A, B , see Figure 12 (right). The truncated volume of the tetrahedron P_3 with vertices $ABCO$ is given by Equation (33). It can be partitioned into the special pyramid P_4 , the tetrahedron $ABCD$, and two birectangular tetrahedra as shown. The volumes of the birectangular tetrahedra are given

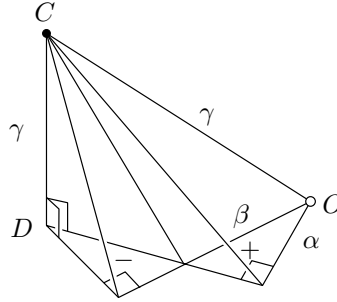

FIGURE 13. The base may also be a self-intersecting quadrilateral. Here, $\beta > \frac{\pi}{2}$.

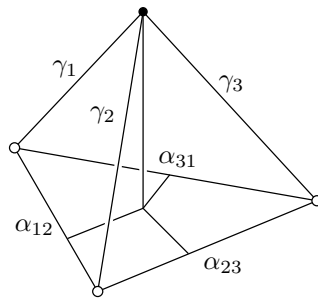

FIGURE 14. Tetrahedron with one ideal and three hyperideal vertices, partitioned into four special pyramids

by Equation (31); they are $\frac{1}{2} \mathcal{J}(\alpha)$ and $\frac{1}{2} \mathcal{J}(\beta)$. The tetrahedron $ABCD$ is symmetric with respect to reflection at the plane that contains edge CD and intersects edge AB orthogonally. This symmetry plane splits the tetrahedron $ABCD$ into two symmetric birectangular tetrahedra. At edge CD , each of them has a dihedral angle of $\frac{1}{2}(\pi - \alpha - \beta + \gamma)$. (To see this consider the dihedral angles of all the pieces at edge CD ; their sum is 2π . Thus the angle in question is $\frac{1}{2}(2\pi - \alpha - \beta - (\pi - \gamma))$.) The volume of the tetrahedron $ABCD$ is therefore $\mathcal{J}(\frac{1}{2}(\pi - \alpha - \beta + \gamma))$. Subtract from the truncated volume of P_4 the volumes of tetrahedron $ABCD$ and the two birectangular tetrahedra to obtain Equation (34). \square

Remark. The same volume formula holds when O is finite instead of hyperideal [36] [37]. In that case $\alpha + \beta + \gamma > \pi$.

Equation (34) holds also when the base is a self-intersecting quadrilateral; see Figure 13. In this case one of the angles α or β is greater than $\frac{\pi}{2}$. We have to regard the pyramid P_4 as a difference of two tetrahedra (with signs as indicated in Figure 13), and its volume as the difference of the volumes of these tetrahedra. One can derive Equation (34) by a similar construction.

7.5. The truncated volume of a tetrahedron with one ideal and three hyperideal vertices. Finally, consider a tetrahedron with one ideal and three hyperideal vertices as shown in Figure 4. Drop the perpendicular from the ideal vertex onto the plane of the opposite face and subdivide the tetrahedron into four special pyramids (the bases of which may be self-intersecting quadrilaterals) as shown in Figure 14. The volume formula for the tetrahedron, Equation (9), is obtained as the sum of the volumes of the four special pyramids, given by Equation (34). (Note $\mathcal{J}(\frac{\pi}{2} - x) = -\mathcal{J}(\frac{\pi}{2} + x)$.) This concludes the proof of Lemma 4.

REFERENCES

1. A. D. Alexandrov, *Convex Polyhedra*, Springer, Berlin, 2005, english edition of the 1950 Russian classic with added material, MR2127379, Zbl 1067.52011.
2. E. M. Andreev, *On convex polyhedra in Lobačevskii spaces*, Math. USSR, Sb. **10** (1970), 413–440, Zbl 0217.46801, translation of MR0259734 (Russian).
3. ———, *On convex polyhedra of finite volume in Lobačevskii spaces*, Math. USSR, Sb. **12** (1970), 255–259, Zbl 0252.52005, translation of MR0273510 (Russian).
4. X. Bao and F. Bonahon, *Hyperideal polyhedra in hyperbolic 3-space*, Bull. Soc. Math. France **130** (2002), no. 3, 457–491, MR1943885, Zbl 1033.52009.
5. A. I. Bobenko and I. Izhestiev, *Alexandrov's theorem, weighted Delaunay triangulations, and mixed volumes*, Preprint arxiv:math.DG/0609447, 2006.
6. A. I. Bobenko and B. A. Springborn, *Variational principles for circle patterns and Koebe's theorem*, Trans. Amer. Math. Soc. **356** (2004), no. 2, 659–689 (electronic), MR2022715, Zbl 1044.52009.
7. A. I. Bobenko and B. A. Springborn, *A discrete Laplace-Beltrami operator for simplicial surfaces*, Preprint arXiv:math.DG/0503219, 2005, to appear in *Discrete Comput. Geom.*
8. B. H. Bowditch, *Singular euclidean structures on surfaces*, J. London Math. Soc. (2) **44** (1991), 553–565, MR1149015, Zbl 0748.57003.
9. P. L. Bowers and M. K. Hurdal, *Planar conformal mappings of piecewise flat surfaces*, Visualization and Mathematics III (Hans-Christian Hege and Konrad Polthier, eds.), Springer-Verlag, Berlin, 2003, MR2046999, Zbl 1069.30011, pp. 3–34.
10. B. Chow and F. Luo, *Combinatorial Ricci flows on surfaces*, J. Differential Geom. **63** (2003), 97–129, MR2015261, Zbl 1070.53040.
11. T. Clausen, *Ueber die Function $\sin \varphi + \frac{1}{2^2} \sin 2\varphi + \frac{1}{3^2} \sin 3\varphi + \text{etc}$* , J. Reine Angew. Math. **8** (1832), 298–300, ERAM 008.0308cj.
12. Y. Colin de Verdière, *Un principe variationnel pour les empilements de cercles*, Invent. Math. **104** (1991), no. 3, 655–669, MR1106755, Zbl 0745.52010.
13. H. S. M. Coxeter, *The functions of Schläfli and Lobatschewsky*, Quarterly Journal of Mathematics (Oxford series) **6** (1935), 13–29, Zbl 0011.17006, republished in *Twelve Geometric Essays*, Southern Illinois University Press, Carbondale, Ill., 1968, pp. 3–20, which was in turn republished as *The Beauty of Geometry. Twelve Essays*, Dover Publications, Mineola, N. Y., 1999, MR0310745.
14. Peter Doyle and Gregory Leibon, *23040 symmetries of hyperbolic tetrahedra*, Preprint arXiv:math.GT/0309187, 2003.
15. H. Edelsbrunner, *Geometry and topology for mesh generation*, Cambridge Monographs on Applied and Computational Mathematics, Cambridge University Press, Cambridge, 2001, MR1833977, Zbl 0981.65028.
16. M. K. Hurdal, P. L. Bowers, K. Stephenson, D. W. L. Sumners, K. Schaper K. Rehm, and D. A. Rotternberg, *Quasi-conformally flat mapping the human cerebellum*, Medical Image Computing and Computer-Assisted Intervention (MICCAI '99) (C. Taylor and A. Colchester, eds.), Lecture Notes in Computer Science, vol. 1679, Springer-Verlag, Berlin, 1999, pp. 279–286.
17. R. Kellerhals, *On the volume of hyperbolic polyhedra*, Math. Ann. **285** (1989), 541–569, MR1027759, Zbl 0664.51012.
18. L. Kharevych, B. Springborn, and P. Schröder, *Discrete conformal mappings via circle patterns*, ACM Transactions on Graphics **25** (2006), no. 2, 412–438.
19. G. Leibon, *Characterizing the Delaunay decompositions of compact hyperbolic surfaces*, Geometry and Topology **6** (2002), 361–391, MR1914573, Zbl 1028.52014.
20. L. Lewin, *Polylogarithms and Associated Functions*, North Holland, New York, 1981, MR0618278, Zbl 0465.33001.
21. N. J. Lobatschewskij, *Imaginäre Geometrie und ihre Anwendung auf einige Integrale*, Abhandlungen zur Geschichte der mathematischen Wissenschaften mit Einschluss ihrer Anwendungen **19** (1904), collection of two articles originally published in Kazan in 1835 and 1836, translated into German from the Russian original, edited and annotated by H. Liebmann.
22. J. Milnor, *Hyperbolic geometry: the first 150 years*, Bull. Amer. Math. Soc. **6** (1982), no. 1, 9–24, MR0634431, Zbl 0486.01006. Republished in [23].
23. ———, *Collected Papers, Volume 1, Geometry*, Publish or Perish, Houston, 1994, MR1277810, Zbl 0857.01015.
24. ———, *How to compute volume in hyperbolic space*, in *Collected Papers* [23], MR1277810, Zbl 0857.01015, pp. 189–212.
25. ———, *The Schläfli differential equality*, in *Collected Papers* [23], MR1277810, Zbl 0857.01015, pp. 281–295.

26. I. Rivin, *Euclidean structures of simplicial surfaces and hyperbolic volume*, Ann. of Math. **139** (1994), 553–580, MR1283870, Zbl 0823.52009.
27. ———, *A characterization of ideal polyhedra in hyperbolic 3-space*, Ann. of Math. (2) **143** (1996), no. 1, 51–70, MR1370757, Zbl 0874.52006.
28. ———, *Combinatorial optimization in geometry*, Adv. in Appl. Math. **31** (2003), no. 1, 242–271, MR1985831, Zbl 1028.52006.
29. R. K. W. Roeder, J. H. Hubbard, and W. D. Dunbar, *Andreev's theorem on hyperbolic polyhedra*, Annales de l'Institut Fourier **57** (2007), no. 3, 825–882.
30. L. Schläfli, *Theorie der vielfachen Kontinuität*, Gesammelte mathematische Abhandlungen, vol. 1, Birkhäuser, 1950, MR0034587, Zbl 0035.21902, pp. 167–392.
31. J.-M. Schlenker, *Hyperideal circle patterns*, Math. Res. Lett. **12** (2005), no. 1, 85–112, MR2122733, Zbl 1067.52016.
32. ———, *Circle patterns on singular surfaces*, Preprint arxiv:math.DG/0601531 v2, 2006.
33. B. A. Springborn, *Variational principles for circle patterns*, Ph.D. thesis, Technische Universität Berlin, 2003, arXiv:math.GT/0312363.
34. K. Stephenson, *Introduction to Circle Packing. The Theory of Discrete Analytic Functions*, Cambridge University Press, Cambridge, 2005, MR2131318, Zbl 1074.52008.
35. William P. Thurston, *The geometry and topology of three-manifolds, chapter 13*, unpublished. An electronic edition is distributed by the MSRI at <http://www.msri.org/publications/books/gt3m/>.
36. E. B. Vinberg, *The volume of polyhedra on a sphere and in Lobachevsky space*, Amer. Math. Soc. Transl. (2) **148** (1991), 15–27, MR1109060, Zbl 0742.51019.
37. ———, *Volumes of non-Euclidean polyhedra*, Russian Math. Surveys **48** (1993), no. 2, 15–45, MR1239859, Zbl 0799.01019.

BORIS SPRINGBORN, TECHNISCHE UNIVERSITÄT BERLIN, INSTITUT FÜR MATHEMATIK, MA 8-3,
STRASSE DES 17. JUNI 136, 10623 BERLIN, GERMANY,
E-mail address: boris.springborn@tu-berlin.de