

CLOSED/OPEN STRING DIAGRAMMATICS

RALPH M. KAUFMANN
DEPARTMENT OF MATHEMATICS
UNIVERSITY OF CONNECTICUT, STORRS, USA

R. C. PENNER
DEPARTMENTS OF MATHEMATICS AND PHYSICS/ASTRONOMY
UNIVERSITY OF SOUTHERN CALIFORNIA, LOS ANGELES, USA

ABSTRACT. We introduce a combinatorial model based on measured foliations in surfaces which captures the phenomenology of open/closed string interactions. The predicted equations are derived in this model, and new equations can be discovered as well. In particular, several new equations together with known transformations generate the combinatorial version of open/closed duality. On the topological and chain levels, the algebraic structure discovered is new, but it specializes to a modular bi-operad on the level of homology.

INTRODUCTION

There has been considerable activity towards a satisfactory diagrammatics of open/closed string interaction and the underlying topological field theories. For closed strings on the topological level, there are the fundamental results of Atiyah and Dijkgraaf [1, 2], which are nicely summarized in [3]. The topological open/closed theory has proved to be trickier since there have been additional unexpected axioms, notably the Cardy condition [4–8]; this algebraic background is again nicely summarized in [9].

In closed string field theory [10–12], there are many new algebraic features [13–15], in particular, coupling to gravity [16, 17] and a Batalin-Vilkovisky structure [18, 19]. This BV structure has the same origin as that underlying string topology [20–24] and the decorated moduli spaces [25–27].

In terms of open/closed theories beyond the topological level, many interesting results have been established for D -branes [28–45] and Gepner models in particular [46–48]. Mathematically, there has also been work towards generalizing known results to the open/closed setting [49–53].

We present a model which accurately reflects the standard phenomenology of interacting open/closed strings and which satisfies and indeed rederives the “expected” equations of open/closed topological field theory and the BV-structure of the closed sector. Furthermore, the model allows the calculation of many new equations, and there is an infinite algorithm for generating all of the equations of this theory on the topological level. A finite set of equations, four of them new, are shown to generate open/closed duality.

The rough idea is that as the strings move and interact, they form the leaves of a foliation, the “string foliation”, on their world-sheets. Dual to this foliation is another foliation of the world-sheets, which comes equipped with the additional structure of a “transverse measure”; as we shall see, varying the transverse measure on the dual “measured foliation” changes the combinatorial type of the string foliation.

The algebra of these string interactions is then given by gluing together the string foliations along the strings, and this corresponds to an appropriate gluing operation on the dual measured foliations. The algebraic structure discovered is new, and we axiomatize it (in Appendix A) as a “closed/open” or “c/o structure”. This structure is present on the topological level of string interactions as well as on the chain level. On the homology level, it induces the structure of a modular bi-operad, which governs c/o string algebras (see Appendix A and Theorem 4.4).

Roughly, a measured foliation in a surface F is a collection of rectangles of some fixed widths and unspecified lengths foliated by horizontal lines (see Appendix B for the precise definition). One glues such a collection of rectangles together along their widths in the natural measure-preserving way (cf. Figure 5), so as to produce a measured foliation of a closed subsurface of F . In the transverse direction, there is a natural foliation of each rectangle also by its vertical string foliation, but this foliation has no associated transverse measure. In effect, the physical length of the string is the width of the corresponding rectangle. A measured foliation does *not* determine a metric on the surface, rather, one impressionistically thinks of a measured foliation as describing *half* of a metric since the widths of the rectangles are determined but not their lengths (see also §B.1 for more details).

Nevertheless, there is a condition that we may impose on measured foliations by rectangles, namely, a measured foliation of F by rectangles is said to *quasi fill* F if every component of F complementary to the rectangles is either a polygon or an exactly once-punctured polygon. The cell decomposition of decorated Riemann’s moduli space for punctured surfaces [54–58] has been extended to surfaces with boundary

in [26], and the space of quasi filling measured foliations by rectangles again turns out to be naturally homotopy equivalent to Riemann’s moduli space of F (i.e., classes of structures on surfaces with one distinguished point in each hyperbolic geodesic boundary component; see the next section for further details). Thus, in contrast to a measured foliation impressionistically representing half a metric, a quasi filling measured foliation actually *does* determine a conformal class of metrics on F . See the closing remarks for a further discussion of this “passage from topological to conformal field theory”.

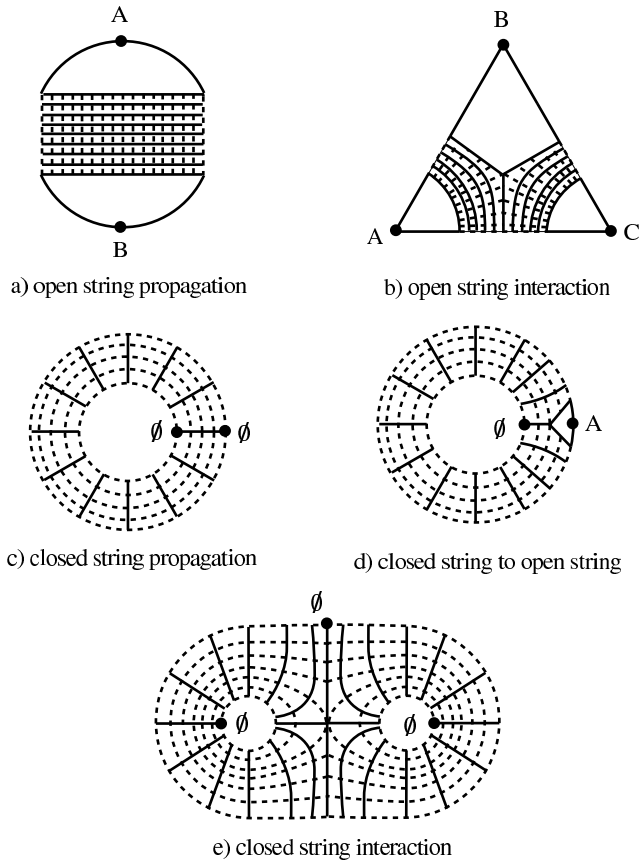

Figure 1 Foliations for several string interactions, where the strings are represented by dashed lines and the dual measured foliation by solid lines. The white regions in parts a-b are for illustration purposes only

More explicitly in Figure 1, each boundary component comes equipped with a non-empty collection of distinguished points that may represent the branes, and the labeling will be explained presently. That part of

the boundary that is disjoint from the foliation and from the distinguished points has no physical significance: the physically meaningful picture arises by replacing each distinguished point in the boundary by a small distinguished arc (representing that part of the interaction that occurs within the corresponding brane) and collapsing to a point each component of the boundary disjoint from the foliation and from the distinguished arcs.

Since the details for general measured foliations may obfuscate the relevant combinatorics and phenomenology of strings, we shall restrict attention for the most part to the special measured foliations where each non-singular leaf is an arc properly embedded in the surface. The more general case is not without interest (see Appendix B).

The natural equivalence classes of such measured foliations are in one-to-one correspondence with “weighted arc families”, which are appropriate homotopy classes of properly and disjointly embedded arcs together with the assignment of a positive real number to each component (see the next section for the precise definition). Furthermore, the quotient of this subspace of foliations by the mapping class group is closely related to Riemann’s moduli space of the surface (again see the next section for the precise statement).

A *windowed surface* $F = F_g^s(\delta_1, \dots, \delta_r)$ is a smooth oriented surface of genus $g \geq 0$ with $s \geq 0$ punctures and $r \geq 1$ boundary components together with the specification of a non-empty finite subset δ_i of each boundary component, for $i = 1, \dots, r$, and we let $\delta = \delta_1 \cup \dots \cup \delta_r$ denote the set of all distinguished points in the boundary ∂F of F and let σ denote the set of all punctures. The set of components of $\partial F - \delta$ is called the set W of *windows*.

In the physical context of interacting closed and open strings, the open string endpoints are labeled by a set of branes in the physical target, and we let \mathcal{B} denote this set of brane labels, where we assume $\emptyset \notin \mathcal{B}$. In order to account for all possible interactions, it is necessary to label elements of $\delta \cup \sigma$ by the power set $\mathcal{P}(\mathcal{B})$ (comprised of all subsets of \mathcal{B}). In effect, the label \emptyset denotes closed strings, and the label $\{B_1, \dots, B_k\} \subseteq \mathcal{B}$ denotes the formal intersection of the corresponding branes. This intersection in the target may be empty in a given physical circumstance.

A *brane-labeling* on a windowed surface F is a function

$$\beta : \delta \sqcup \sigma \rightarrow \mathcal{P}(\mathcal{B}),$$

where \sqcup denotes the disjoint union, so that if $\beta(p) = \emptyset$ for some $p \in \delta$, then p is the unique point of δ in its component of ∂F . A brane-labeling may take the value \emptyset at a puncture. (In effect, revisiting windowed

surfaces from [61] now with the additional structure of a brane-labeling leads to the new combinatorial topology of the next sections.)

A window $w \in W$ on a windowed surface F brane-labeled by β is called *closed* if the endpoints of w coincide at the point $p \in \delta$ and $\beta(p) = \emptyset$; otherwise, the window w is called *open*.

To finally explain the string phenomenology, consider a weighted arc family in a windowed surface F with brane-labeling β . To each arc a in the arc family, associate a rectangle R_a of width given by the weight on a , where R_a is foliated by horizontal lines as before. We shall typically dissolve the distinction between a weighted arc a and the foliated rectangle R_a , thinking of R_a as a “band” of arcs parallel to a whose width is the weight. Disjointly embed each R_a in F with its vertical sides in W so that each leaf of its foliation is homotopic to a rel δ . Taken together, these rectangles produce a measured foliation of a closed subsurface of F as before, and the leaves of the corresponding unmeasured vertical foliation represent the strings.

Thus, a weighted arc family in a brane-labeled windowed surface represents a string interaction. Given such surfaces F_i with weighted arc families α_i and a choice of window w_i of F_i , for $i = 1, 2$, suppose that the sum of the weights of the arcs in α_1 meeting w_1 agrees with the sum of the weights of the arcs in α_2 meeting w_2 . In this case as in open/closed cobordism (see e.g. [9]), we may glue the surfaces F_1, F_2 along their windows w_1, w_2 respecting the orientations so as to produce another oriented surface F_3 , and because of the condition on the weights, we can furthermore combine α_1 and α_2 to produce a weighted arc family α_3 in F_3 (cf. Figure 5). This describes the basic gluing operations, namely, the operations of a *c/o* structure on the space of all weighted arc families in brane-labeled windowed surfaces (cf. Section 2 for full details). Furthermore, these operations descend to the chain and homology levels as well (cf. Section 2 and Appendix A).

As we shall explain (in Section 3), the degree zero indecomposables of the *c/o* structure are illustrated in Figures 3 and 4, and further useful degree one indecomposables are illustrated in Figure 6 (whose respective parts a-e correspond to those of Figure 1.)

Relations in the *c/o* structure of weighted arc families or measured foliations are derived from decomposable elements, i.e., from the fact that a given surface admits many different decompositions into “generalized pairs of pants” (see the next section), so the weighted arc families or measured foliations in it can be described by different compositions of indecomposables in the *c/o* structure.

We shall see that all of the known equations of open/closed string theory, including the “commutative and symmetric Frobenius algebras,

Gerstenhaber-Batalin-Vilkovisky, Cardy, and center (or knowledge)” equations, hold for the c/o structure on chains on weighted arc families (cf. Figures 7-11).

Furthermore, we shall derive several new such equations (cf. Figure 12) and in particular a set of four new equations which together with known relations generate closed/open string duality (see Theorem 3.1).

Indeed, it is relatively easy to generate many new equations of string interactions in this way, and we shall furthermore (in Section 3.2) describe an algorithm for generating all equations of all degrees on the topological level, and in a sense also on the chain level.

We turn in Section 4 to the algebraic analysis of Section 3 and derive independent sets of generators and relations in degree zero on the topological, chain, or homology levels. In particular, this gives a new non-Morse theoretic calculation of the open/closed cobordism group in dimension two [5, 9]. Several results on higher degree generators and relations are also presented, and there is furthermore a description of algebras over our c/o structure on arc families.

Having completed this “tour” of the figures and this general physical discussion of the discoveries and results contained in this paper, let us next state an “omnibus” theorem likewise intended to summarize the results mathematically:

Theorem *For every brane-labeled windowed surface (F, β) , there is a space $\widetilde{\text{Arc}}(F, \beta)$ of mapping class group orbits of suitable measured foliations in F together with geometrically natural operations of gluing surfaces and measured foliations along windows. These operations descend to the level of piecewise-linear or cubical chains for example.*

These operations furthermore descend to the level of integral homology and induce the structure of a modular bi-operad, cf. [9]. Algebras over this bi-operad satisfy the expected equations as articulated in Theorem 4.4.

Furthermore, new equations can also be derived in the language of combinatorial topology: pairs of “generalized pants decompositions” of a common brane-labeled windowed surface give rise to families of relations.

In degree zero on the homology level, we rederive the known presentation of the open/closed cobordism groups [5, 9], and further partial algebraic results are given in higher degrees. In particular, several new relations (which have known transformation laws) are shown to act transitively on the set of all generalized pants decompositions of a fixed brane-labeled windowed surface.

This paper is organized as follows. §1 covers the basic combinatorial topology of measured foliations in brane-labeled windowed surfaces and their generalized pants decompositions leading up to a description of the indecomposables of our theory, which in a sense go back to the 1930's. §2 continues in a similar spirit to combinatorially define the spaces $\widehat{Arc}(n, m)$ underlying our algebraic structure on the topological level as well as the basic gluing operations on the topological level. The operations on the chain level then follow tautologically. The operations on the homology level require the analysis of certain fairly elaborate flows, which are defined and studied in Appendix C and also discussed in §2. In §3 continuing with combinatorial topology, we present generators, relations, and finally prove the result that appropriate moves act transitively on generalized pants decompositions. §4 finally turns to the algebraic discussion of the material described in §3 and explains the precise sense in which the figures actually represent traditional algebraic equations; §4 furthermore presents our new algebraic results about string theory. Closing remarks in particular include a discussion of how one might imagine our results extending from topological to conformal field theory.

Appendix A gives the formal algebraic definition and basic properties of a *c/o* structure, and Appendix B briefly surveys Thurston's theory of measured foliations from the 1970-80's and describes the extension of the current paper to the setting of general measured foliations on windowed surfaces. It is fair to say that Appendix A could be more appealing to a mathematician than a physicist (for whom we have tried to make Appendix A optional by emphasizing the combinatorial topology in the body of the paper), and that the physically speculative Appendix B should probably be omitted on a first reading in any case.

Appendix C defines and studies certain flows which are fundamental to the descent to homology as described in Appendix A. Nevertheless, the discussion of the flows and their salient properties in Appendix C is independent of the technical aspects of Appendix A (since chains are interpreted simply as parameterized families); in a real sense, Appendix C is the substance of this paper beyond the combinatorial topology, algebraic structure, and phenomenology, so we have strived to keep it generally accessible.

1. WEIGHTED ARC FAMILIES, BRANE-LABELING, AND
GENERALIZED PANTS DECOMPOSITIONS

1.1. **Weighted arc families in brane-labeled windowed surfaces.**

In the notation of the introduction, consider a windowed surface $F = F_g^s(\delta_1, \dots, \delta_r)$, with punctures σ , boundary distinguished points $\delta = \delta_1 \cup \dots \cup \delta_r$ and windows W , together with a brane-labeling $\beta : \delta \cup \sigma \rightarrow \mathcal{P}(B)$. Define the sets

$$\begin{aligned}\delta(\beta) &= \{p \in \delta : \beta(p) \neq \emptyset\}, \\ \sigma(\beta) &= \{p \in \sigma : \beta(p) \neq \emptyset\}.\end{aligned}$$

Fix some brane label $A \in \mathcal{B}$, and define the brane-labeling β_A to be the constant function on $\delta \cup \sigma$ with value $\{A\}$; β_A corresponds to the “purely open sector with a space-filling brane-label”. On the other hand, the constant function β_\emptyset with value \emptyset corresponds to the “purely closed sector”.

It is also useful to have the notation $F_{g,(\#\delta_1, \dots, \#\delta_r)}^s$, where $\#S$ is the cardinality of a set S . For instance, a pair of pants with one distinguished point on each boundary component is a surface of type $F_{0,(1,1,1)}^0$, while the data of the windowed surface $F_g^s(\delta_1, \delta_2, \delta_3)$ includes the specification of one point in each boundary component as well. One further point of convenient notation is that we shall let simply $F_{g,r}^s$ denote a surface of genus g with s punctures and $r > 0$ boundary components when there is a unique distinguished point on each boundary component.

Define a β -arc a in F to be an arc properly embedded in F with its endpoints in W so that a is not homotopic fixing its endpoints into $\partial F - \delta(\beta)$. For example, given a distinguished point $p \in \partial F$, consider the arc lying in a small neighborhood that simply connects one side of p to another in F ; a is a β -arc if and only if $\beta(p) \neq \emptyset$.

Two β -arcs are *parallel* if they are homotopic rel δ , and a β -arc family is the homotopy class rel δ of a collection of β -arcs, no two of which are parallel. Notice that we take homotopies rel δ rather than rel $\delta(\beta)$.

A *weighting* on an arc family is the assignment of a positive real number to each of its components.

Let $\text{Arc}'(F, \beta)$ denote the geometric realization of the partially ordered set of all β -arc families in F . $\text{Arc}'(F, \beta)$ is described as the set of all projective positively weighted β -arc families in F with the natural topology. (See for instance [25] or [59] for further details and Figure 2 below for an illustrative example.)

The (*pure*) *mapping class group* $MC(F)$ of F is the group of orientation-preserving homeomorphisms of F pointwise fixing $\delta \cup \sigma$ modulo homotopies pointwise fixing $\delta \cup \sigma$. $MC(F)$ acts naturally on $Arc'(F, \beta)$ by definition with quotient the *arc complex*

$$Arc(F, \beta) = Arc'(F, \beta)/MC(F).$$

We shall also require the corresponding deprojectivized versions: $\widetilde{Arc}'(F, \beta) \approx Arc'(F, \beta) \times \mathbb{R}_{>0}$ is the space of all positively weighted arc families in F with the natural topology, and

$$\widetilde{Arc}(F, \beta) = \widetilde{Arc}'(F, \beta)/MC(F) \approx Arc(F, \beta) \times \mathbb{R}_{>0}.$$

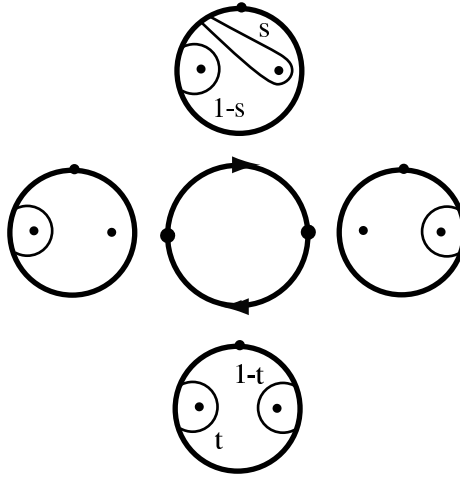

Figure 2 The arc complex $Arc(F_{0,1}^2, \beta_\emptyset)$ is homeomorphic to a circle S^1 . We omit the common label \emptyset at each point of $\delta \cup \sigma$ to avoid cluttering the figure. There are exactly the two $MC(F_{0,1}^2)$ -orbits of β_\emptyset -arcs on the right and left. These can be disjointly embedded in the two distinct ways at the top and bottom. As the parameter t on the bottom varies in the range $0 \leq t \leq 1$, there is described a projectively weighted β_\emptyset -arc family, that is, the two disjoint arcs determine a one-dimensional simplex in $Arc(F, \beta_\emptyset)$, and likewise for the parameter s on the top. The two one-simplices are incident at their endpoints as illustrated to form a circle $Arc(F, \beta_\emptyset) \approx S^1$. Furthermore, $Arc'(F, \beta_\emptyset) \approx \mathbb{R}$, $\widetilde{Arc}(F, \beta_\emptyset) \approx S^1 \times \mathbb{R}_{>0}$, and $\widetilde{Arc}'(F, \beta_\emptyset) \approx \mathbb{R} \times \mathbb{R}_{>0}$ with the primitive mapping classes acting by translation by one on \mathbb{R} .

It will be useful in the sequel to employ a notation similar to that in Figure 2, where parameterized collections of arc families are described by pictures of arc families together with functions next to the components, where the functions represent the parameterized evolution of

weights. We shall also typically let the icon \bullet denote either a puncture or a distinguished point on the boundary as in Figure 2.

In contrast to Figure 2, if we instead consider the purely open sector with space-filling brane-label β_A , for $A \neq \emptyset$, then there is yet another $MC(F_{0,1}^2)$ -orbit of arc encircling the boundary distinguished point. In this case, $Arc(F_{0,1}^2, \beta_A)$ is homeomorphic to the join of the circle in Figure 2 with the point representing this arc, namely, $Arc(F_{0,1}^2, \beta_A)$ is homeomorphic to a two-dimensional disk.

For another example of an arc complex, take the brane-labeling $\beta_\emptyset \equiv \emptyset$ on $F_{0,2}^0$, for which again $MC(F_{0,2}^0) \approx \mathbb{Z}$. There is a unique $MC(F_{0,2}^0)$ -orbit of singleton β_\emptyset -arc, and there are two possible $MC(F_{0,2}^0)$ -orbits of β_\emptyset -arc families with two component arcs illustrated in Figure 3. Again, $Arc(F_{0,2}^0, \beta_\emptyset)$ is homeomorphic to a circle. If $A \neq \emptyset$, then $Arc(F_{0,2}^0, \beta_A)$ is homeomorphic to a three-dimensional disk.

To explain the connection with earlier work, consider the purely closed sector $\beta_\emptyset \equiv \emptyset$ on $F = F_{g,r}^s$. Let $Arc_\#(F)$ denote the subspace of $Arc(F, \beta_\emptyset)$ corresponding to all projective positively weighted arc families α so that each component of $F - \cup \alpha$ is either a polygon or an exactly once-punctured polygon, i.e., α quasi fills F ; $Arc_\#(F)$ was shown in [26] to be proper homotopy equivalent to a natural bundle over Riemann's moduli space of the bordered surface F as defined in the Introduction provided F is not an annulus ($g = s = 0, r = 2$).

Let $Arc(F) \supseteq Arc_\#(F)$ denote the subspace of $Arc(F, \beta_\emptyset)$ corresponding to all projective positively weighted arc families α so that each window of F (i.e., each boundary component) has at least one arc in α incident upon it. The spaces $Arc(F)$ comprise the objects of the basic topological operad studied in [25].

1.2. Generalized pants decompositions. A *generalized pair of pants* is a surface of genus zero with r boundary components and s punctures, where $r + s = 3$, with exactly one distinguished point on each boundary component, that is, a surface of type $F_{0,3}^0$, $F_{0,2}^1$, or $F_{0,1}^2$.

A (*standard*) *pants decomposition* Π of a windowed surface $F = F_g^s(\delta_1, \dots, \delta_r)$ is (the homotopy class of) a collection of disjointly embedded essential curves in the interior F , no two of which are homotopic, together with a condition on the complementary regions to Π in F .

To articulate this condition, let us enumerate the curves c_1, \dots, c_K in Π , choose disjoint annular neighborhoods U_k of c_k in F , for $k =$

$1, \dots, K$, and set $U = U_1 \cup \dots \cup U_K$. Just for the purposes of articulation, let us also choose on each boundary component of U a distinguished point. We require that each component of $F - U$ is a generalized pair of pants or a boundary-parallel annulus of type $F_{0,(1,n)}^0$, for some $n \geq 1$.

Simple Euler characteristic considerations give the following lemma.

Lemma 1.1. *For a windowed surface $F = F_g^s(\delta_1, \dots, \delta_r)$, there are $\#W = \sum_i \#\delta_i = \#\delta$ many windows. The real dimension of $\text{Arc}(F, \beta_\emptyset)$ is $6g - 7 + 3r + 2s + \#\delta$. Furthermore, there are $3g - 3 + 2r + s$ curves in a pants decomposition Π of F and $2g - 2 + r + s$ generalized pairs of pants complementary to an annular neighborhood of the pants curves.*

If β is a brane-labeling on the windowed surface F , then a *generalized pants decomposition* of (F, β) is (the homotopy class of) a family of disjointly embedded closed curves in the interior of F and arcs with endpoints in $\delta(\beta) \cup \sigma(\beta)$, no two of which are parallel, so that each complementary region is one of the following *indecomposable brane-labeled surfaces*:

- a triangle $F_{0,(3)}^0$ with no vertex brane-labeled by \emptyset ;
- a generalized pair of pants $F_{0,3}^0$, $F_{0,2}^1$, or $F_{0,1}^2$ with all points δ in the boundary brane-labeled by \emptyset ;
- a once-punctured monogon $F_{0,1}^1$ with puncture brane-labeled by \emptyset and boundary distinguished point by $A \neq \emptyset$;
- an annulus $F_{0,2}^0$ with at least point of δ labeled by \emptyset .

For instance, if every brane label is empty, then a generalized pants decomposition is a standard pants decomposition. At the other extreme, if every brane label is non-empty, then F admits a decomposition into triangles and once-punctured monogons, a so-called *quasi triangulation* of F , cf. [58]; see Figures 12b and 13 for examples. Provided there is at least one non-empty brane label, we may collapse each boundary component with empty brane label to a puncture to produce another windowed surface F' from F . A quasi triangulation of F' can be completed with brane-labeled annuli to finally produce a generalized pants decomposition of F itself.

Thus, any brane-labeled windowed surface admits a generalized pants decomposition. Furthermore, any collection of disjointly embedded essential curves and arcs connecting non-empty brane labels so that no two components are parallel can be completed to a generalized pants decomposition.

1.3. Indecomposables. We shall introduce standard foliations on indecomposable surfaces which are the basic building blocks of the theory, and we begin with the annulus in Figure 3.

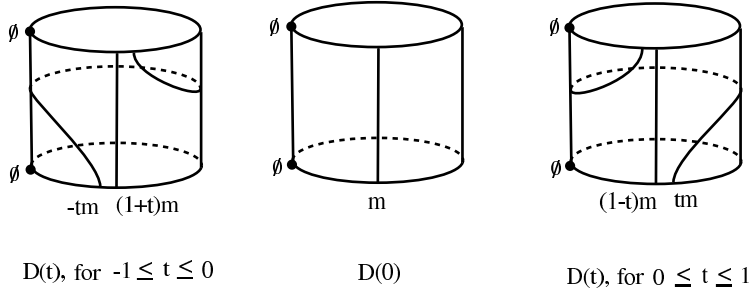

Figure 3 The twist flow on $\widetilde{Arc}'(\mathcal{A}, \beta_\emptyset)$.

In the notation of Figure 3, consider the purely closed sector with brane-labeling $\beta_\emptyset \equiv \emptyset$ on a fixed annulus \mathcal{A} of type $F_{0,2}^0$. Define a one-parameter “Dehn twist flow” $D(t)$, for $-1 \leq t \leq 1$, on $\widetilde{Arc}'(\mathcal{A}, \beta_\emptyset)$, as illustrated in the figure, where m denotes the sum of the weights of the arcs in $\alpha \in \widetilde{Arc}'(\mathcal{A}, \beta_\emptyset)$. Letting T denote the right Dehn twist along the core of the annulus, one extends to all positive real values of t by setting $D(t)(\alpha) = T^{[t]}D(t - [t])(\alpha)$, where $[t]$ denotes the integral part of t , and likewise for negative real values of t .

Figure 4 illustrates the remaining building blocks of the theory. Notice that $F_{0,1}^1$ brane-labeled with some β taking value \emptyset on the boundary is absent from Figure 4 and implicitly from the theory since $Arc(F_{0,1}^1, \beta)$ is empty.

A fact going back to Max Dehn in the 1930’s is that “free” homotopy classes rel $\delta(\beta_\emptyset) = \emptyset$ in a fixed pair of pants \mathcal{P} of type $F_{0,3}^0$ are determined by the three “intersection numbers” m_1, m_2, m_3 , namely, the number of endpoints of component arcs in each respective boundary component, subject to the unique constraint that $m_1 + m_2 + m_3$ is even. Two representative cases are illustrated in Figure 4e, and the full partially ordered set is illustrated in Figure 4d. There are conventions in the pair of pants that have been suppressed here insofar as the “arc connecting a boundary component to itself goes around the right leg of the pants”; see Figure 4f and see [60] for details.

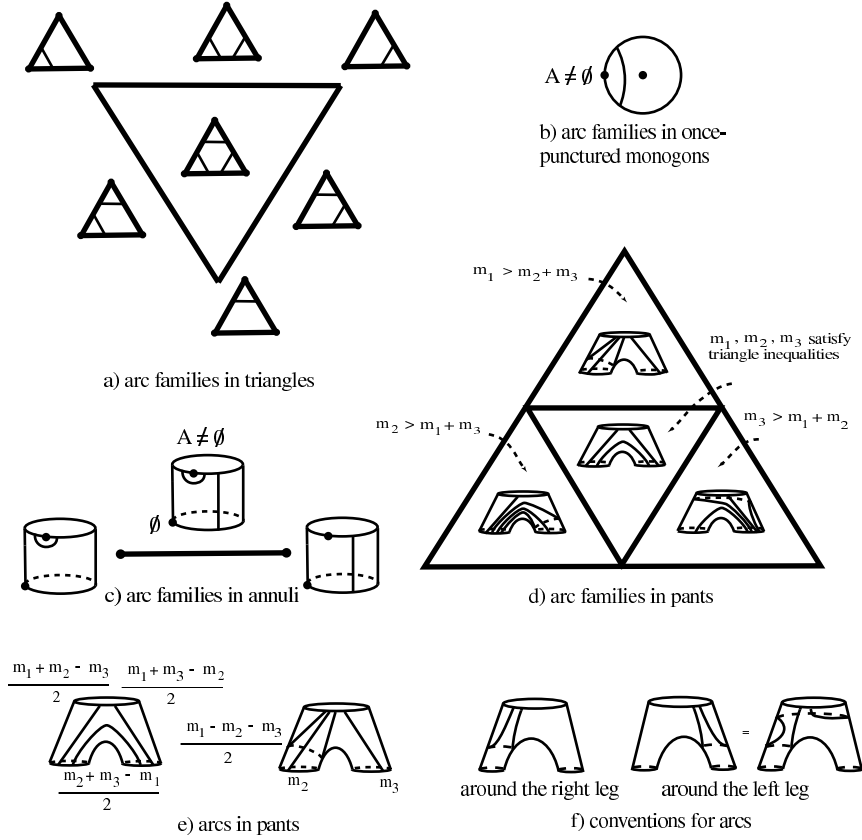

Figure 4 Indecomposables. We depict the geometric realization of $Arc(F_{0,(3)}^0, \beta)$ in part a for some brane-labeling β whose image does not contain \emptyset , and which is simply omitted from the figure. There is the unique element of $Arc(F_{0,1}^1, \beta)$ depicted in part b when the brane-label on the boundary is non-empty. For the brane-labeling β on $F_{0,2}^0$ indicated in part c, we consider instead the homotopy classes of β -arc families rel $\delta(\beta)$, rather than rel δ as before. Likewise, for the brane-labeling β_\emptyset on $F_{0,3}^0$, which we omit from the figure, we consider again the homotopy classes of β_\emptyset -arc families rel $\delta(\beta_\emptyset)$, where $\delta(\beta_\emptyset) = \emptyset$ by definition, and depict the geometric realization in part d.

One further remark is that arc families in all generalized pairs of pants are also implicitly described by Figures 4d-f, where punctures correspond to boundary components with no incident arcs.

1.4. Standard models of arc families. Suppose that Π is a generalized pants decomposition of a brane-labeled windowed surface (F, β) , where Π has curve components c_1, \dots, c_K and arc components d_1, \dots, d_L .

Let U_k denote a fixed annular neighborhood of c_k for $k = 1, \dots, K$, and set $U = U_1 \cup \dots \cup U_K$.

In order to parameterize weighted arc families, we must make several further choices, as follows. Choose a framing to the normal bundle to each curve c_k , which thus determines an identification of the unit normal bundle to c_k in F with the standard annulus \mathcal{A} . In turn, the unit normal bundle is also identified with the neighborhood U_k , and there is thus an identification of U_k with \mathcal{A} determined by the framing on c_k . Furthermore, choose homeomorphisms of each generalized pair of pants component of $F - U$ with some standard generalized pair of pants \mathcal{P} . Choose an embedded essential arc a_0 once and for all in \mathcal{A} , and likewise choose standard models for arc families in \mathcal{P} (say, with the conventions for twisting as in Figure 4f). Let us call a generalized pants decomposition together with this specification of further data a *basis* for arc families.

Given $\alpha \in \widetilde{\text{Arc}}(F, \beta)$, choose a representative weighted arc family that meets each component of Π transversely a minimal number of times, let m_k denote the sum of the weights of the arcs in α that meet c_k counted with multiplicity (and without a sign), and let n_ℓ denote the analogous sum for the arcs d_ℓ .

Theorem 1.2. *Fix a basis for arc families with underlying generalized pants decomposition Π of a brane-labeled windowed surface (F, β) , and adopt the notation above given some $\alpha \in \widetilde{\text{Arc}}'(F, \beta)$. Then under the identifications with the standard annulus \mathcal{A} and standard pants \mathcal{P} , α is represented by a weighted arc family that meets complementary regions to U in F in exactly one of the configurations shown in Figure 4 and meets each U_k in $D(t_k)(a_0)$ for some well-defined $t_k \in \mathbb{R}$, where a_0 is weighted by m_k . Furthermore, a point of $\widetilde{\text{Arc}}'(F)$ is uniquely determined by its coordinates (m_k, t_k) for $k = 1 \dots K$ and n_ℓ , for $\ell = 1, \dots, L$.*

Proof. Since the arcs in a generalized pants decomposition connect points of $\delta \cup \sigma$ and the components of an arc family avoid a neighborhood of $\delta \cup \sigma$, intersections with triangles and once-punctured monogons are established. We may homotope an arc family to a standard model in each pair of pants; the twisting numbers t_k are then the weighted algebraic intersection numbers (with a sign) with a_0 in each annulus (all arcs oriented from top-to-bottom or bottom-to-top of the annulus); see the ‘‘Dehn-Thurston’’ coordinates from [61], [60] for further details. \square

Corollary 1.3. *In the notation of Theorem 1.2, any parameterized family in $\widetilde{\text{Arc}}(F, \beta)$ is represented by one that meets complementary regions to U in F in parameterized families of the configurations shown in Figure 4 and meets each U_k in $D(t_k)(a_0)$, where t_k depends upon the parameters, for $k = 1, \dots, K$. Furthermore, a parameterized family is uniquely determined by its parameterized coordinates (m_k, t_k) for $k = 1 \dots K$ and n_ℓ , for $\ell = 1, \dots, L$. \square*

Notice that in either case of the theorem or the corollary, the intersection numbers on any triangle satisfy all three possible weak triangle inequalities.

2. C/O STRING OPERATIONS ON WEIGHTED ARC FAMILIES

Recall that a window $w \in W$ in a brane-labeled windowed surface F is *closed* if its closure is an entire boundary component of F and the distinguished point complementary to w is brane-labeled by \emptyset , and otherwise the window is *open*.

Given a positively weighted arc family in F , let us furthermore say that a window $w \in W$ is *active* if there is an arc in the family with an endpoint in w , and otherwise the window is *inactive*.

In order to most directly connect with the usual phenomenology of strings, we shall require all windows to be active, but the more general case of operations on inactive windows is not uninteresting, specializes to the treatment here, and will be discussed in Appendix B.

Given a positively weighted arc family in F , we may simply collapse each inactive window, or consecutive sequence of inactive windows in a boundary component, to a new distinguished point on the boundary, where the brane-labeling of the resulting distinguished point is the union of all the brane labels on the endpoints of the windows collapsed to it. In case a boundary component consists entirely of inactive windows, then it is collapsed to a new puncture, which is again brane-labeled by the union of all the brane labels on the collapsed boundary component. Thus, given any positively weighted arc family in F , there is a corresponding positively weighted arc family in a corresponding surface so that each window is active. (This is one explanation for why we brane-label by the power-set of branes, namely, in order to effectively take every window to be active.)

For any windowed surface F , define

$$\widetilde{Arc}(F) = \bigsqcup \widetilde{Arc}(F, \beta),$$

where the disjoint union is over all brane-labelings on F . The basic objects of our topological c/o structure are

$$\widetilde{Arc}(n, m) = \bigsqcup \left\{ \alpha \in \widetilde{Arc}(F) : \begin{array}{l} \alpha \text{ has } n \text{ closed and } m \text{ open active} \\ \text{windows and no inactive windows} \end{array} \right\},$$

where the disjoint union is over all orientation-preserving homeomorphism classes of windowed surfaces.

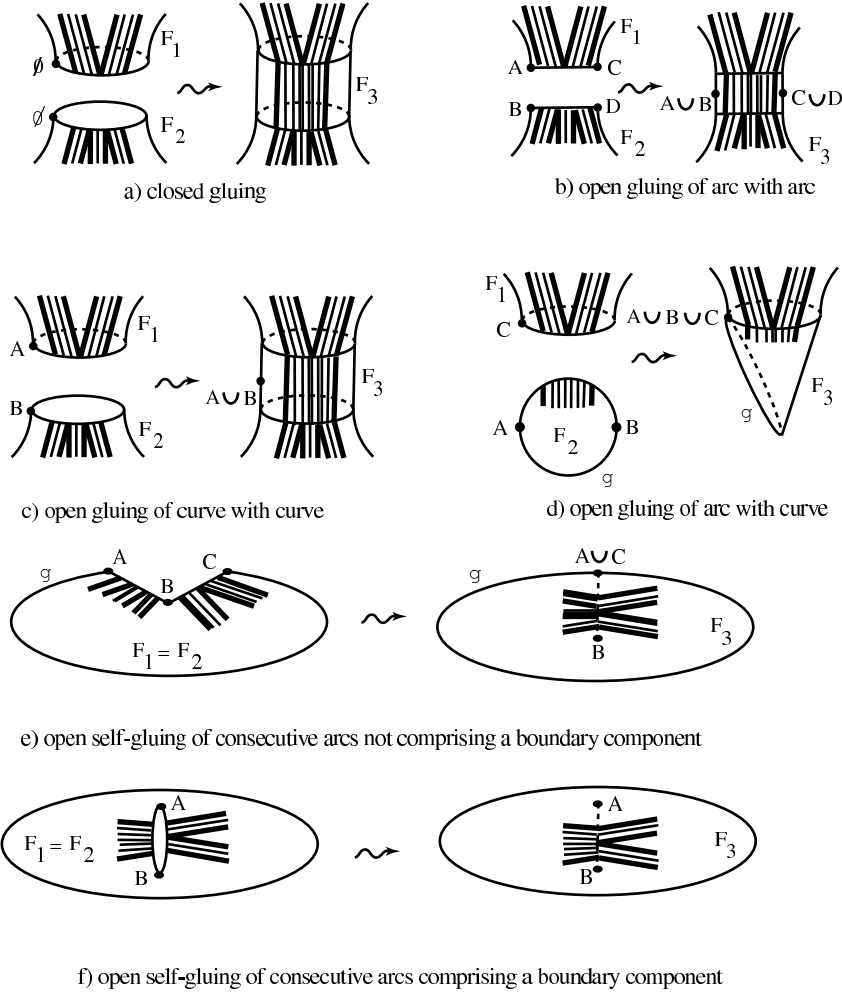

Figure 5 The c/o operations on measured foliations.

If $\alpha \in \widetilde{\text{Arc}}(n, m)$, then define the α -weighting of an active window w to be the sum of the weights of arcs in α with endpoints in w , where we count with multiplicity (so if an arc in α has both endpoints in w , then the weight of this arc contributes twice to the weight of w).

Suppose we have a pair of arc families α_1, α_2 in respective windowed surfaces F_1, F_2 and a pair of active windows w_1 in F_1 and w_2 in F_2 , so that the α_1 -weight of w_1 agrees with the α_2 -weight of w_2 . Since F_1, F_2 are oriented surfaces, so too are the windows w_1, w_2 oriented. In each operation, we identify windows reversing orientation, and we identify certain distinguished points.

To define the open and closed gluing ($F_1 \neq F_2$) and self-gluing ($F_1 = F_2$) of α_1, α_2 along the windows w_1, w_2 , we identify windows and distinguished points in the natural way and combine foliations. In closed string operations, we “replace the distinguished point, so there is no puncture” whereas with open string operations, “distinguished points always beget either other distinguished points or perhaps punctures”. In any case whenever distinguished points are identified, one takes the union of brane labels (the intersection of branes) at the new resulting distinguished point or puncture.

More explicitly, the general procedure of gluing defined above specializes to the following specific operations on the $\widetilde{\text{Arc}}(n, m)$:

Closed gluing and self-gluing See Figure 5a. Identify the two corresponding boundary components of F_1 and F_2 , identifying also the distinguished points on them *and then including this point in the resulting surface* F_3 . F_3 inherits a brane-labeling from those on F_1, F_2 in the natural way. We furthermore glue α_1 and α_2 together in the natural way, where the two collections of foliated rectangles in F_1 and F_2 which meet w_1 and w_2 have the same total width by hypothesis and therefore glue together naturally to provide a measured foliation \mathcal{F} of a closed subsurface of F_3 . (The projectivization of this gluing operation is precisely the composition in the cyclic operad studied in [25]; we have deprojectivized and included the weighting condition in the current paper in order to allow self-gluing of closed strings as well.)

Open gluing The surfaces F_1 and F_2 are distinct, and we identify w_1 to w_2 to produce F_3 . There are cases depending upon whether the closure of w_1 and w_2 is an interval or a circle. The salient cases are illustrated in Figure 5b-d. In each case, distinguished points on the boundary in F_1 and F_2 are identified to produce a new distinguished boundary point in F_3 , and the brane labels are combined, as is also illustrated. As before, since the α_1 -weight on w_1 agrees with the α_2 -weight on w_2 ,

the foliated rectangles again combine to provide a measured foliation \mathcal{F} of a closed subsurface of F_3 .

Open self-gluing There are again cases depending upon whether the closure of w_1 or w_2 is a circle or an interval, but there is a further case as well when the two intervals lie in a common boundary component and are consecutive. Other than this last case, the construction is identical to those illustrated in Figure 5b-d. In case the two windows are consecutive along a common boundary component, again they are identified so as to produce surface F_3 with a puncture resulting from their common endpoint as in Figure 5e-f, where the puncture is brane-labeled by the label of this point, and the foliated rectangles combine to provide a measured foliation \mathcal{F} of a closed subsurface of F_3 .

At this stage, we have only constructed a measured foliation \mathcal{F} of a closed subsurface of F_3 , and indeed, \mathcal{F} will typically not be a weighted arc family. By Poincaré recurrence, the sub-foliation \mathcal{F}' comprised of leaves that meet ∂F corresponds to a weighted arc family α_3 in F_3 . Notice that the α_3 -weight of any window uninvolved in the operation agrees with its α_1 - or α_2 -weight, so in particular, every window of F_3 is active for α_3 .

Let us already observe here that the part of \mathcal{F} that we discard to get α_3 can naturally be included (as we shall discuss in Appendix B). Furthermore, notice that a gluing operation never produces a “new” puncture brane-labeled by \emptyset .

The assignment of α_3 in F_3 to α_i in F_i , for $i = 1, 2$ completes the definition of the various operations. Associativity and equivariance for bijections are immediate, and so we have our first non-trivial example of a c/o structure (see Appendix A for the precise definition):

Theorem 2.1. *Together with open and closed gluing and self gluing operations, the spaces $\widetilde{\text{Arc}}(n, m)$ form a topological c/o structure. Furthermore, this c/o structure is brane-labeled by $\mathcal{P}(\mathcal{B})$ and is a $(g, \chi - 1)$ - c/o structure, where g is the genus and χ is the Euler-characteristic.*

Proof. See Appendix A for the definitions and the proof. □

Corollary 2.2. *The open and closed gluing operations descend to operations on the PL chain complexes of $\widetilde{\text{Arc}}(n, m)$ giving them a chain level c/o structure.*

Proof. We define a “chain level c/o structure” in such a manner that this follows immediately from the previous theorem; see Appendix A for details. \square

Theorem 2.3. *The integral homology groups $H_*(\widetilde{Arc}(n, m))$ comprise a modular bi-operad when graded by genus for closed gluings and self-gluings and by Euler-characteristic-minus-one for open gluings and self-gluings.*

Proof. In contrast to the previous corollary, this requires more than just a convenient definition since we must first show that the gluing operations descend to the level of homology; specifically, given homology classes in $\widetilde{Arc}(n, m)$ and $\widetilde{Arc}(n', m')$, we must find representative chains that assign a common weight on the windows to be glued.

This is accomplished by introducing two continuous flows on $\widetilde{Arc}(F, \beta)$ for each window w , namely, ψ_t^w , for $0 \leq t \leq 1$ for non self-gluing and ϕ_t^w , for $-1 \leq t < 1$ for self-gluing, where β is a fixed brane-labeling on the windowed surface F . In effect for non self-gluing, ψ_t^w simply scales in the $\mathbb{R}_{>0}$ -action on $\widetilde{Arc}(F, \beta)$ so that the weight of window w is unity at time one. To describe the key attributes of the more complicated flow for self-gluing, suppose that $w' \neq w$ is any other window of F and $\alpha \in \widetilde{Arc}(F, \beta)$ where the α -weight of w' is less than the α -weight of w .

There is a well-defined “critical” value $t_c = t_c(\alpha)$ of t so that the $\phi_{t_c}^w(\alpha)$ -weight of w first agrees with the $\phi_{t_c}^{w'}(\alpha')$ -weight of w' ; furthermore, the function $t_c(\alpha)$ is continuous in α .

These flows are defined and studied in Appendix C, and the theorem then follows directly from Proposition A.2. \square

3. OPERATIONS, RELATIONS, DUALITY

3.1. Operations. Operations may be conveniently described by weighted arc families, or by parameterized families of weighted arc families. If a parameterized family of arc families depends upon p real parameters, then we shall say that it is an operation of *degree* p . In order to establish notation, the standard operations in degrees zero and one are illustrated in Figure 6.

In this figure, the distinguished points on the boundary come with an enumeration that we have typically suppressed. Only for clarity for the bracket in Figure 6k do we indicate the enumeration of the distinguished points with the numerals “1” and “2”; we shall omit such enumerations in subsequent figures since they can be inferred from the incidence and labeling of arcs in the figure.

It is worth remarking that the BV operator $\Delta_a(t)$ is none other than the projection to $MC(F)$ -orbits of the Dehn twist operator $D(t)$ discussed in Section 1.3.

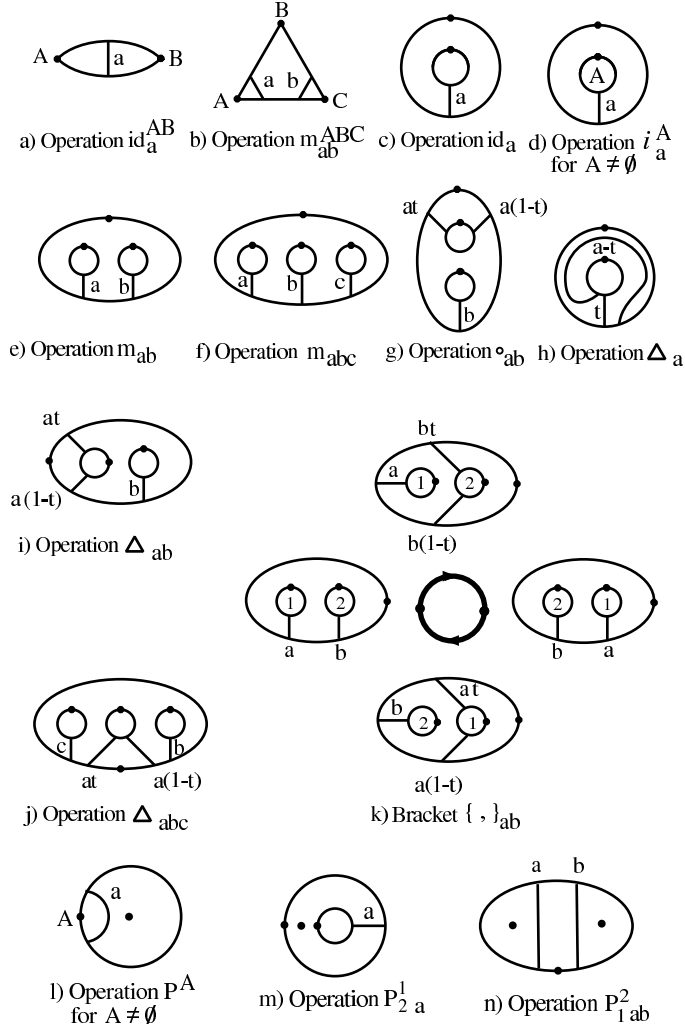

Figure 6 Standard operations of degrees zero and one. If there is no brane-label indicated, then the label is tacitly taken to be \emptyset . See Section 4.1 for the traditional algebraic interpretations.

3.2. Relations. Relations in the c/o structure on $\widetilde{Arc}(n, m)$ or its chain complexes can be described and derived by fixing some decomposable windowed surface F , choosing two generalized pants decompositions Π, Π' of F and specifying an arc family α or a parameterized

family of arc families in F . Each of Π and Π' decompose F into indecomposable surfaces and annular neighborhoods of the pants curves.

According to Theorems 1.2 and 2.1, α thus admits two different descriptions as iterated compositions of operations in the c/o structure, and these are equated to derive the corresponding algebraic relations. We shall abuse notation slightly and simply write an equality of two pictures of F , one side of the equation illustrating α and Π in F and the other illustrating α and Π' ; we shall explain the algebraic interpretations in the next section. As with operations, a relation on a p parameter family of weighted arc families is said to have *degree* p .

Accordingly, Figures 7 and 8 illustrate all of the standard relations of two-dimensional open/closed cobordism (cf. [5, 7–9]). In particular, notice that the “Whitehead move” in Figure 7a corresponds to associativity of the open string operation. The Cardy equation in Figure 7e depends upon the two generalized pants decompositions Π, Π' of the surface $F_{0,2}^0$ with no empty brane labels, where Π consists of a single simple closed curve, and Π' is an ideal triangulation.

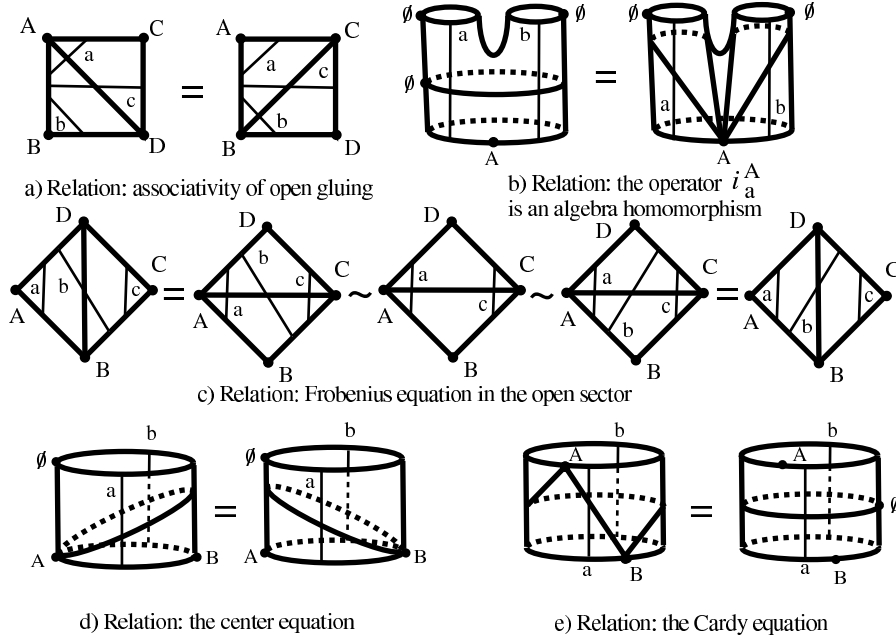

Figure 7 Open/closed cobordism relations.

The Frobenius equation is more interesting since it consists of two pairs (α_i, Π_i) , for $i = 1, 2$, where (α_i, Π_i) is comprised of a weighted arc family α_i with each window active and an ideal triangulation Π_i of a quadrilateral; see Figure 7c at the far left and right. Perform the unique possible Whitehead move on Π_i to get Π'_i , for $i = 1, 2$. In

fact, the pairs (α_1, Π'_1) and (α_2, Π'_2) are not identical, rather they are homotopic in $Arc(0, 4)$, as is also illustrated in Figure 7c.

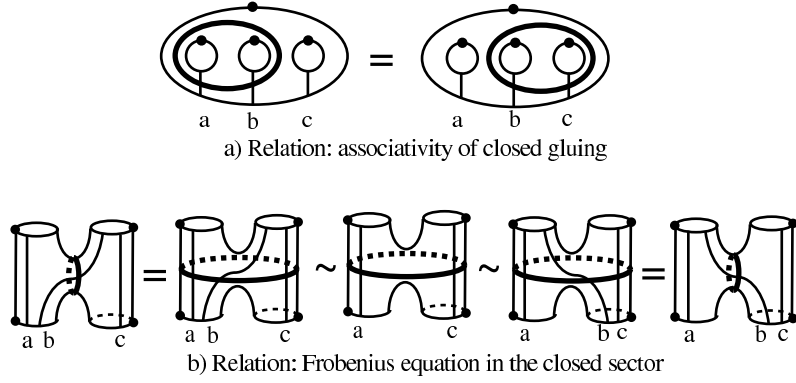

Figure 8 Further open/closed cobordism relations: associativity and the Frobenius equation in the closed sector.

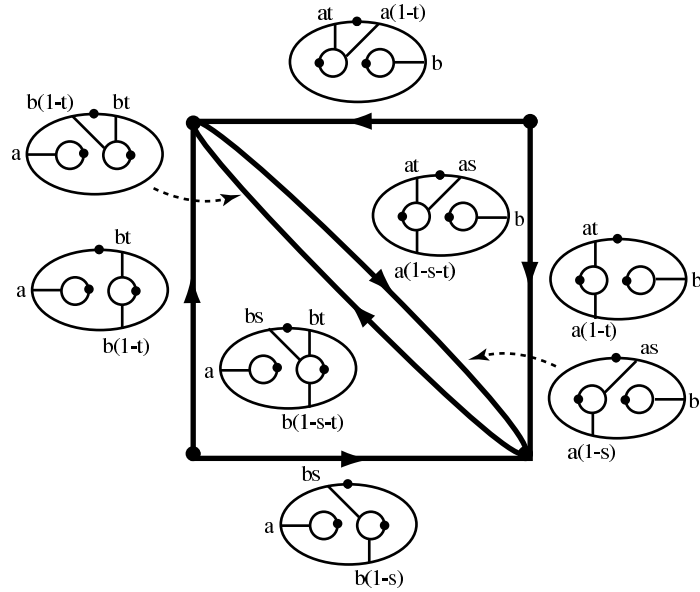

Figure 9 Closed sector relations: compatibility of bracket and composition.

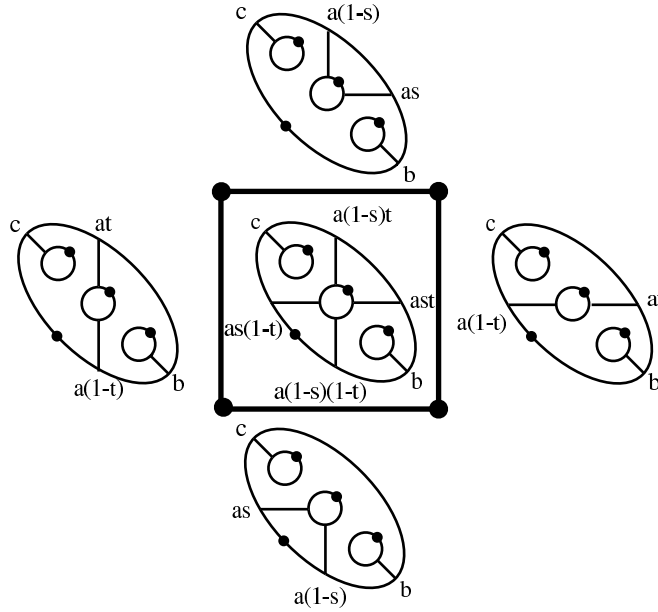

Figure 10 Homotopy for one-third of the BV equation.

The other closed sector relations were already confirmed in [25] and are rendered in Figures 8-11 in the current formalism, where all brane-labelings are tacitly taken to be \emptyset ; furthermore all boundary-parallel pants curves are omitted from the figures (except in Figure 11 for clarity). The Frobenius equation is again degree one, and the BV equation itself is degree two.

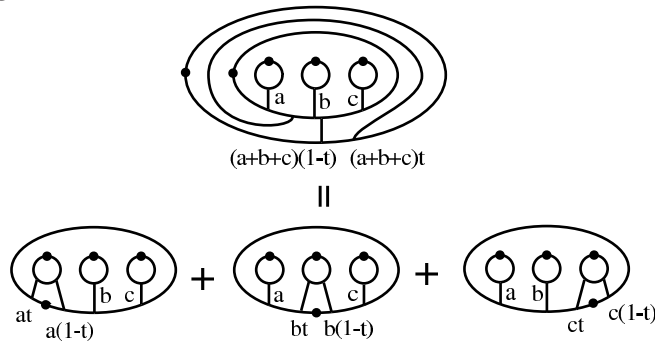

Figure 11 The homotopy BV equation. There are three summands in Figure 11, each of which is parameterized by an interval, which together combine to give the sides of a triangle. For each side of this triangle, there is the homotopy depicted in Figure 10 with the appropriate labeling. Glue the three rectangles from Figure 10 to the three sides of the triangle in the manner indicated. The BV equation is then the fact that one boundary component of this figure (9 terms) is homotopic to the other boundary component (3 terms); Figure 11 of [25] renders this entire homotopy.

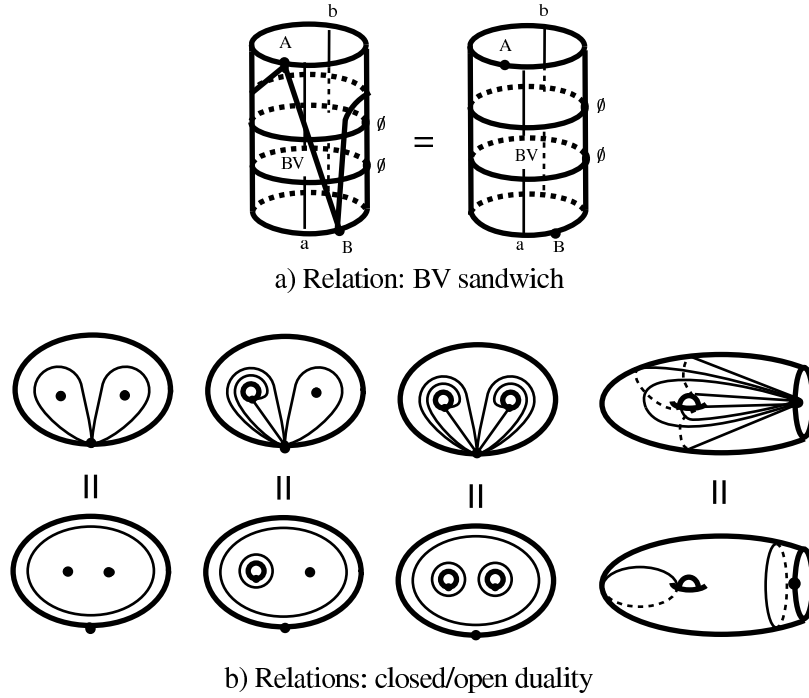

Figure 12 New relations.

It is thus straight-forward to discover new relations, and several such relations of some significance are indicated in Figure 12. Figure 12a illustrates a degree one equation on $F_{0,2}^0$ called the “BV sandwich”, which can be succinctly described by “close an open string, perform a BV twist, and then open the closed string”. One-parameter families of weighted arc families on two triangles are combined by parameterized open string gluing to produce a closed string BV twist sandwiched between closing/opening the string. The significance of the relations in Figure 12b and the justification for the choice of terminology will be explained in the next section.

Here is an algorithm for deriving all of the relations in degree zero on the topological level: Induct over the topological type of the surface and over the $MC(F)$ -orbits of all pairs of generalized pants decompositions of it. (Though there are only finitely many $MC(F)$ -orbits of singleton generalized pants decompositions, there are infinitely many $MC(F)$ -orbits of pairs.) In each indecomposable piece, consider each of the possible building blocks illustrated in Figures 3-4. Among these countably many equations are all of the degree zero equations of the topological c/o structure.

To derive all higher degree relations on the topological level, notice that each indecomposable surface has (the geometric realization of) its arc complexes of some fixed rather modest dimension. Thus, parameterized families may be described as specific parameterized families in each building block, for instance, in the coordinates of Corollary 1.3. Such parameterized families can be manipulated using known transformations (see the next section) to explicitly relate coordinates for different generalized pants decompositions and derive all topological relations.

A fortiori, topological relations hold on the chain level (and likewise for the chain and homology levels as well). For parameterized families, there is again the analogous exhaustively enumerative algorithm, but one must recognize when two parameterized families are homotopic, which is another level of complexity.

It is thus not such a great challenge to discover new relations in this manner. The remaining difficulties involve systematically understanding not only higher degree equations like the BV sandwich but also in determining a minimal set of relations, and especially in understanding the descent to homology.

3.3. Open/closed duality. We seek a collection of combinatorially defined transformations or “moves” on generalized pants decompositions of a fixed brane-labeled windowed surface, so that finite compositions of these moves act transitively. In particular, then any closed string interaction (a standard pants decomposition of a windowed surface brane-labeled by the emptyset) can be opened with the “opening operator” $(i_a^A)^*$ illustrated in Figure 6d, say with a single brane-label A ; this surface can be quasi triangulated, giving thereby an equivalent description as an open string interaction.

In particular, the two moves in Figure 13a-b were shown in [58] to act transitively on the quasi triangulations of a fixed surface, and likewise the two “elementary moves” on $F_{1,1}^0$ and $F_{0,4}^0$ of Figure 13c-d were shown in [62] to act transitively on standard pants decompositions, where we include also the generalized versions of Figure 13d on $F_{0,r}^s$ with $r + s = 4$ and Figure 13c on $F_{1,0}^1$ as well (though this includes some non-windowed surfaces strictly speaking).

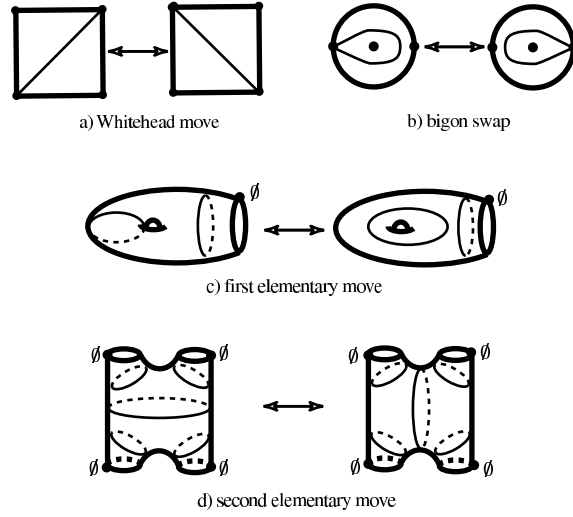

Figure 13 Four combinatorial moves, where absent brane labels are arbitrary.

For another example, the Cardy equation can be thought of as a move between the two generalized pants decompositions depicted in Figure 7e, and likewise for the four new relations in Figure 12b.

Theorem 3.1. *Consider the following set of combinatorial moves: those illustrated in Figure 13 together with the Cardy equation Figure 7e, and the four closed/open duality relations Figure 12b. Finite compositions of these moves act transitively on the set of all generalized pants decompositions of any surface.*

Proof. In light of the transitivity results mentioned above by topological induction, it remains only to show that the indicated moves allow one to pass between some standard pants decomposition and some quasi triangulation of a fixed surface F of type $F_{g,r}^s$. This follows from the fact that on any surface other than those in Figure 7e and 12b, one can find in F a separating curve γ separating off one of these surfaces. Furthermore, one can complete γ to a standard pants decomposition Π so that there is at least one window in the same component of $F - \cup \Pi$ as γ . Choose an arc a in $F - \cup \Pi$ connecting a window to γ ; the boundary of a regular neighborhood of $a \cup \gamma$ corresponds to one of the enumerated moves, and the theorem follows by induction. \square

It is an exercise to calculate the effect of these moves on the natural coordinates in Theorem 1.2 in the case of the quadrilateral $F_{0,(4)}^0$ and the once-punctured monogon $F_{0,1}^1$, and the calculation of the new duality

relations on generalized pairs of pants $F_{0,r}^s$, for $r + s = 3$, and on $F_{1,1}^0$ is implicit in Figure 4. The calculation of the first elementary move on $F_{1,1}^0$ is also not so hard, but the formulas are unfortunately incorrectly rendered in [67]; see [61] or [71]. The calculation of the second elementary move on $F_{0,4}^0$, a problem going back to Dehn, was solved in [61].

4. ALGEBRAIC PROPERTIES ON THE CHAIN AND HOMOLOGY LEVELS

4.1. Operations on the chain level. The moves discussed in the last section give rise to relations on the chain level as well. As explained in Appendix A upon fixing a chain functor $Chain$, a chain may be thought of as a parameterized family of arc families, i.e., as a suitable continuous function $a(s) \in \widetilde{Arc}(n, m)$, where s represents a tuple of parameters. The gluing operations on the chain level can furthermore be thought of as gluing in families, where the gluing is possible when the weights of the appropriate windows agree in the two families. As mentioned previously, any relation on the topological level gives rise to a relation of degree zero on the chain level. Some of the relations we discuss will be only up to homotopy, i.e., of higher degree.

Given any $a \in Chain(\widetilde{Arc}(n, m))$, i.e., given any suitable parameterized family $a(s) \in \widetilde{Arc}(n, n)$ on a component of $\widetilde{Arc}(n, m)$, say with underlying surface F , we may fix a window w on F and regard a, w as an operation in many different ways:

$(n+m-1)$ -ary operation: given chains a_1, \dots, a_{n+m-1} , each on a surface with distinguished window, glue them to all windows of F except w ; the $n + m - 1$ inputs a_1, \dots, a_{n+m-1} yield the output w ;

dual unary operation: given a chain b on a surface with distinguished window, glue it to F along w to produce the chain we shall denote $a^*(b)$; the input b yields the output $a^*(b)$.

More generally, we may partition the windows of the underlying surfaces into inputs and outputs to obtain more exotic operations associated with chains. (The mathematical structure of PROPs were invented to formalize this structure; for a review see [64, 65].)

For instance, let us explain the sense in which the constant chain m_{ab}^{ABC} in Figure 6b describes the binary operation of multiplication. Taking the base of the triangle as the distinguished window w , consider families $a(s) \in Chain(\widetilde{Arc}(n, m))$ with distinguished window w_a and

$b(t) \in \widetilde{Chain}(Arc(n', m'))$ with distinguished window w_b , where the brane labels at the endpoints of w_a are A, B and of w_b are B, C . These chains can be glued to the constant family m_{ab}^{ABC} if and only if the weight of $a(s)$ on its distinguished window is constant equal to a and the weight of $b(t)$ on its distinguished window is constant equal to b . Let the base of the triangle in Figure 6b be the window 0, the side AB the window 1, and the side BC the window 2. The chain operation is defined as $(m_{ab}^{ABC} \bullet_{1, w_a} a(s)) \bullet_{2, w_b} b(t)$. Notice that the resulting chain will have constant weight $a + b$ on its window 0. It is in this sense that we shall regard the constant chain m_{ab}^{ABC} as a binary multiplication.

On the other hand m_{ab}^{ABC} acts as a co-multiplication as well: given $a(s)$ with brane labels A, C on its distinguished window, we have $m_{ab}^{ABC*} \circ a(s) = m_{ab}^{ABC} \bullet_{0, w_a} a(s)$.

4.1.1. Degree 0 indecomposables and relations. Degree zero chains are generated by zero-dimensional families, that is, by points of the spaces $\widetilde{Arc}(n, m)$.

For the indecomposable brane-labeled surfaces of §1.2, the relevant degree 0 chains are enumerated in Figure 6a-e and 6l-n. They become explicit operators by fixing the distinguished window w to be the lower side in 6a, the base in 6b and the outside boundary in 6c-e and 6l-n: this is the algebraic meaning of the illustrations in Figure 6. For example, 6b and 6e give the respective open and closed binary multiplications m_{ab}^{ABC} and m_{ab} , while 6a and 6c give the respective identities id_a^{AB} and id_a on their domains of definition, namely, families whose weight on the distinguished window is constant equal to a . The subscripts indicate compatibility for chain gluing and self-gluing in the chain level c/o structure, and the superscripts denote brane-labels in the open sector.

It follows from Figures 7a and 8a, that the multiplications m_{ab}^{ABC} and m_{ab} are associative:

$$m_{a+c, b}^{ADB} \circ (m_{ac}^{ACD} \otimes id_b^{BC}) = m_{a, b+c}^{ACB} \circ (id_a^{AC} \otimes m_{c, b}^{CDB}), \quad (4.1)$$

$$m_{a+c, b} \circ (m_{ac} \otimes id_b) = m_{a, b+c} \circ (id_a \otimes m_{c, b}), \quad (4.2)$$

where \circ means the usual composition of operations. The dual unary operations to these multiplications satisfy the Frobenius equations up to homotopy as shown in Figure 7c for the open sector:

$$\begin{aligned} (id_a^{AD} \otimes m_{bc}^{DBC}) \circ (m_{ab}^{BDA*} \otimes id_c^{BC}) &= m_{a, b+c}^{CDA*} \circ m_{a+b, c}^{ABC} \sim m_{ac}^{CDA*} \circ m_{ac}^{ABC} \\ &\sim m_{a+b, c}^{CDA*} \circ m_{a, b+c}^{ABC} = (m_{ab}^{ABD} \otimes id_c^{CD}) \circ (id_a^{AB} \otimes m_{bc}^{CDB*}), \quad (4.3) \end{aligned}$$

and in Figure 8b for the closed sector:

$$\begin{aligned} (id \otimes m_{bc}) \circ (m_{ab}^* \otimes id) &= m_{a,b+c}^* \circ m_{a+b,c} \sim m_{ac}^* \circ m_{ac} \\ &\sim m_{a+b,c}^* \circ m_{a,b+c} = (m_{ab} \otimes id) \circ (id \otimes m_{bc}^*). \end{aligned} \quad (4.4)$$

The ‘‘closing’’ operation i_a^A of Figure 7d acts as a unary operation which changes one window from open to closed. Its dual ‘‘opening’’ operation changes one closed to one open window. It follows from Figure 7b that i_a^A is an algebra homomorphism:

$$i_{a+b}^A \circ m_{ab} = m_{ab}^{AAA} \circ (i_a^A, i_b^A). \quad (4.5)$$

The image of i_a^A lies in the center, as in Figure 7d:

$$m_{ab}^{ABA^*} \circ i_a^A = \tau_{1,2} \circ m_{ba}^{BAB^*} \circ i_b^B, \quad (4.6)$$

where τ_{12} interchanges the tensor factors, namely, interchanges the two non-base sides of the triangle, and it satisfies the Cardy equation in Figure 7e:

$$i_{a+b}^A \circ i_{a+b}^{B^*} = m_{ab}^{ABA} \circ \tau_{1,2} \circ m_{ab}^{BAB^*}. \quad (4.7)$$

The operators in Figures 6l-n are puncture operators, which are ‘‘shift operators for the puncture grading’’.

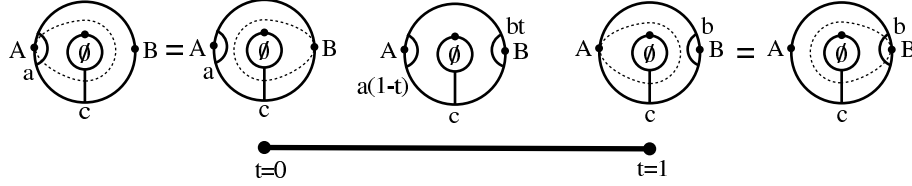

Figure 14 Homotopy of Equation (4.8) to Equation (4.6), where the dotted lines indicate generalized pants decompositions.

We finally express the center equation in a less symmetric but more familiar form:

$$m_{ac}^{AAB} \circ (i_b^A \circ id) \sim m_{ba}^{ABB} \circ \tau_{1,2} \circ (i_b^B \circ id). \quad (4.8)$$

As indicated in Figure 14, the equation (4.8), which is represented by the far left and right figures, is equivalent on the chain level to two copies of our equation (4.6), represented by the two equalities in the figure, which holds on the nose.

4.1.2. Degree one indecomposables and relations. The known degree one operations are given by the binary operation \circ_{ab} of Figure 7g and the operation Δ_a of Figure 7h. These operations are related,

indeed, they satisfy the GBV equations up to homotopy: \circ_{ab} is a homotopy pre-Lie operation whose induced homotopy Gerstenhaber structure coincides with the induced homotopy Gerstenhaber structure of the homotopy BV operator Δ_a (see Figures 9-11). This completes the discussion of know relations.

There is a degree one chain which is of interest, namely, the family which is generated by the BV sandwich setting $a = t$ and $b = a - t$ in Figure 12a. This is supported on the annulus $F_{0,2}^0$ with brane labels A and B. We shall call this operator D_a^{AB} . The BV sandwich equation then gives the equality of chain level operators

$$D_a^{A,B} = (i_a^B)^* \circ \Delta_a \circ i_a^A \quad (4.9)$$

In the same spirit, there is another degree one chain which is associated to $m_{t,(a-t)}^{ABC}$ for $0 \leq t \leq 1$. Although this chain is not closed, it appears naturally as follows. Using the BV sandwich relation for the chain D_a^{AB} , we see that it also decomposes as:

$$D_a^{AB} = m_{(a-t),t}^{ABA} \circ \tau_{1,2} \circ m_{(a-t),t}^{BAB*} \quad (4.10)$$

Thus, $D_a^{A,B}$ admits the two expressions (4.9) and (4.10), so the chain $D_a^{BC} D_a^{AB}$, which is a kind of ‘‘BV-squared in the open sector’’, likewise admits the two expressions corresponding to the two different generalized pants decompositions of $F_{0,2}^1$:

$$\begin{aligned} D_a^{BC} D_a^{AB} &= (i_a^C)^* \circ D_a \circ i_a^B \circ (i_a^B)^* \circ D_a \circ i_a^A \\ &= m_{(a-t),t}^{BCB} \circ \tau_{1,2} \circ m_{(a-t),t}^{CBC*} \circ m_{(a-t),t}^{ABA} \circ \tau_{1,2} \circ m_{(a-t),t}^{BAB*}. \end{aligned}$$

See the closing remarks for a further discussion of this operator D_a^{AB} .

Lemma 4.1. *Suppose that (F, β) is an indecomposable brane-labeled windowed surface. If F is a triangle or a once-punctured monogon, then $\widetilde{\text{Arc}}(F, \beta)$ is contractible. For an annulus, $\widetilde{\text{Arc}}(F, \beta)$ is homotopy equivalent to a circle, and for a generalized pair of pants with $r > 0$ boundary components, $\widetilde{\text{Arc}}(F, \beta)$ is homotopy equivalent to the Cartesian product of r circles.*

Proof. The claims for triangles and once-punctured monogons are clear from Figure 4a-b. For the degree one indecomposables, we first have the annuli $F_{0,2}^0$ brane-labeled by \emptyset, \emptyset or by $\emptyset, A \neq \emptyset$; the free generator of the first homology of the former is precisely the BV operator Δ , while the free generator of the latter is $i^A \circ_{1,1} \Delta$, where 1 is the window labeled by \emptyset . In each case, we have that $\widetilde{\text{Arc}}(F_{0,2}^0, \beta)$ is homotopy equivalent to

a circle. For $(F_{0,1}^2, \beta_\emptyset)$, we again have $\widetilde{\text{Arc}}(F_{01}^2, \beta_\emptyset)$ homotopy equivalent to a circle as in Figure 2, with the free generator $P_2^1 \circ \Delta$.

For the generalized pairs of pants, first notice that the set of *all* homotopy classes of families of projective weighted arcs in a generalized pair of pants with $r > 0$ boundary components (where the arc family need *not* meet each boundary component) is homeomorphic to the join of r circles. (In effect, a point in the circle determines a projective foliation of the annulus as in Figure 3, and one deprojectivizes and combines as in Figure 4d to produce a foliation of the pair of pants.). The complement of two spaces in their join is homeomorphic to the Cartesian product of the two spaces with an open interval, and the lemma follows. In fact, the first homology of $\widetilde{\text{Arc}}(F_{0,2}^1, \beta_\emptyset)$ is freely generated by $\Delta \circ_{1,1} P_2$, and $\Delta \circ_{1,2} P_2$, and the first homology of $\widetilde{\text{Arc}}(F_{0,3}^0, \beta_\emptyset)$ is freely generated by $\Delta \circ_{1,1} m_a$, $\Delta \circ_{1,2} m_a$, and $\Delta \circ_{1,3} m_a$. \square

For a final chain calculation, consider the degree two chain defined by $\Delta_{sq}^B = \Delta_a \circ (i_a^B)^* \circ i_a^B \circ \Delta_a$, which is another type of “BV-squared operator in the open sector” arising on the surface $F_{0,2}^1$ with brane-labeling β given by \emptyset on the boundary and by B at the puncture. In fact, Δ_{sq}^B generates $H_2(\widetilde{\text{Arc}}(F_{0,2}^1, \beta))$, where $H_2(\widetilde{\text{Arc}}(F_{0,2}^1, \beta)) = \mathbb{Z}$ by Lemma 4.1.

Tautologically, $\Delta_{sq}^B(s, t)$ can be written as the sum of two non-closed chains $\Delta_{sq}^B = (\Delta_{sq}^B)_+ + (\Delta_{sq}^B)_-$ given by

$$\begin{aligned} (\Delta_{sq}^B)_+ &= \Delta_a(t) \circ i_a^B \circ (i_a^B)^* \circ \Delta_a(s); & s + t \leq 1, \\ (\Delta_{sq}^B)_- &= \Delta_a(t) \circ i_a^B \circ (i_a^B)^* \circ \Delta_a(s); & s + t \geq 1. \end{aligned} \quad (4.11)$$

Furthermore, we may homotope each of the operators $(i_a^C)^* \circ (\Delta_{sq}^B)_+ \circ i_a^A$ and $(i_a^C)^* \circ (\Delta_{sq}^B)_- \circ i_a^A$ into “traces over multiplications” in the following sense, where we concentrate on $(\Delta_{sq}^B)_+$ with the parallel discussion for $(\Delta_{sq}^B)_-$ omitted. Consider the homotopy of arc families in $F_{0,2}^1$ depicted in Figure 15, which begins with $(\Delta_{sq}^B)_+$ and ends with the indicated family. Cutting on the dotted lines in Figure 15 decomposes each surface into a hexagon, and these hexagons may be triangulated into four triangles corresponding to four multiplications. Thus, each of the operations $(\Delta_{sq}^B)_+$ and $(\Delta_{sq}^B)_-$ is given as the double trace over a quadruple multiplication. Again, see the closing remarks for a further discussion of these operators.

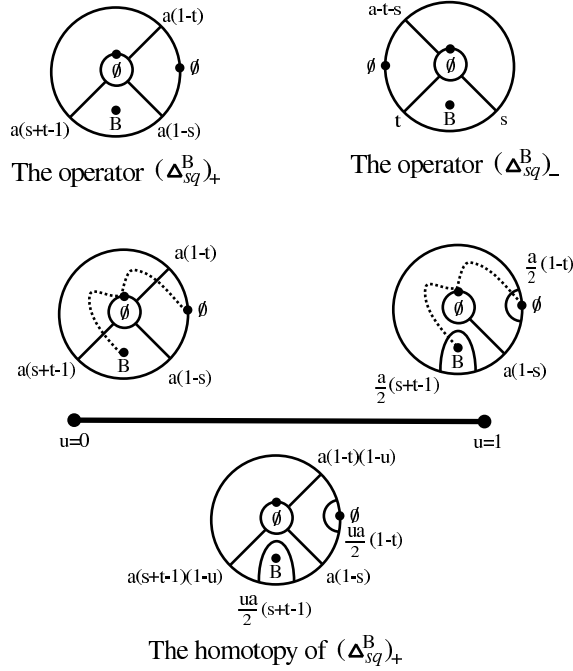

Figure 15 The operators $(\Delta_{sq}^B)_\pm$ and the homotopy of $(\Delta_{sq}^B)_+$.

4.2. Algebraic properties on the homology level. Since $\widetilde{Arc}(F, \beta)$ is connected for any windowed surface F with brane-labeling β , we conclude

$$H_0(\widetilde{Arc}(n, m)) = \bigoplus \mathbb{Z},$$

the sum over all homeomorphism classes of brane-labeled surfaces (F, β) with n closed and m open windows. It follows that the degree zero relations on the homology level are precisely those holding on the chain level up to homotopy.

This observation together with Theorem 3.1 implies the result of [5, 9] that the open/closed cobordism group admits the standard generators with the complete set of relations depicted in Figures 7 and 8: associativity, algebra homomorphism, the Frobenius equations, center and Cardy together with duality.

Lemma 4.2. *Each component of $\widetilde{Arc}(0, m)$ is contractible, hence the homology $H_*(\widetilde{Arc}(0, m))$ is concentrated in degree 0.*

Proof. Consider the foliation which has a little arc around each of the points of δ with constant weight one. We can define a flow on $\widetilde{Arc}(0, m)$, by including these arcs with any element $\alpha \in \widetilde{Arc}(0, m)$ and then

increasing their weights to one while decreasing the weights of all the original arcs to zero. \square

In particular, the first open BV operator D_a^{AB} itself thus vanishes on the homology level, while the second open BV operator $i_B \circ \Delta$ and even its “square” Δ_{sq}^B do not. (The situation may be different in conformal field theory as discussed in the closing remarks.)

Let m, m^{ABC}, i^A be the respective images in homology of the chains m_1, m_{11}^{ABC}, i_1^A , define P^A, P_2^1, P_1^2 to be the images of the puncture operators $P_1^A, P_{21}^1, P_{11}^2$ in homology, and Δ the image in homology of Δ_1 .

Just as chains can be regarded as operators on the chain level, so too homology classes can be regarded as operators on the homology level.

Proposition 4.3. *The degree zero operators on homology are precisely generated by the degree zero indecomposables m, m^{ABC} and i^A provided $\emptyset \notin \beta(\sigma)$, where σ denotes the set of punctures. If $\emptyset \in \beta(\sigma)$, then one must furthermore include the operators P^A, P_2^1, P_1^2 . The degree zero relations on homology are precisely those given by the moves of Theorem 3.1. All operations of all degrees supported on indecomposable surfaces are generated by the degree zero operators and Δ .*

Proof. The degree zero operators arise from constant families and each $\widetilde{\text{Arc}}(F, \beta)$ is connected. By Theorem 1.2, the operators of degree zero arise from degree zero chains on indecomposable surfaces, proving the first part. The second part follows from Lemma 4.1. \square

Theorem 4.4. *Suppose $\emptyset \notin \beta(\sigma)$. Then an algebra over the modular bi-operad $H_*(\coprod_{n,m} \widetilde{\text{Arc}}(n, m))$ is a pair of vector spaces (C, \mathcal{A}) which have the following properties: C is a commutative Frobenius BV algebra (C, m, m^*, Δ) , and $\mathcal{A} = \bigoplus_{(A,B \in \mathcal{P}(\mathcal{B})) \times \mathcal{P}(\mathcal{B})} \mathcal{A}_{AB}$ is a $\mathcal{P}(\mathcal{B})$ -colored Frobenius algebra (see e.g., [9] for the full list of axioms). In particular, there are multiplications $m^{ABC} : \mathcal{A}_{AB} \otimes \mathcal{A}_{BC} \rightarrow \mathcal{A}_{AC}$ and a non-degenerate metric on \mathcal{A} which makes each \mathcal{A}_{AA} into a Frobenius algebras.*

Furthermore, there are morphisms $i^A : C \rightarrow \mathcal{A}_{AA}$ which satisfy the following equations: letting i^* denote the dual of i , τ_{12} the morphism permuting two tensor factors, and letting A, B be arbitrary non-empty brane-labels, we have

$$i^B \circ i^{A*} = m_B \circ \tau_{12} \circ m_A^* \quad (\text{Cardy}) \quad (4.12)$$

$$i^A(C) \text{ is central in } \mathcal{A}_A \quad (\text{Center}) \quad (4.13)$$

$$i^A \circ \Delta \circ i^{B*} = 0 \quad (\text{BV vanishing}) \quad (4.14)$$

These constitute a spanning set of operators and a complete set of independent relations in degree zero. All operations of all degrees supported on indecomposable surfaces are generated by the degree zero operators and Δ .

Proof. By definition, an algebra over a modular operad is a vector space with a non-degenerate bilinear form such that the operations are compatible with dualization [63]. The previous proposition substantiates the first sentence of the theorem, and the second sentence follows in particular.

The claim that i^A and i_A^* are morphisms and the Cardy and center equations then follow from the chain level equations and the fact that the operation a^* for a chain a is in fact the dual operation on the Frobenius algebra. Indeed by Theorem 3.1, the Cardy and Center equations generate the relations in degree zero. Finally, BV vanishing follows from Lemma 4.2 and the last assertion from Lemma 4.1. \square

Notice that if A is a symmetric Frobenius algebra with a pairing $\langle \cdot, \cdot \rangle$ then our center equation (4.6) $m^{ABA^*} \circ i^a = \tau_{1,2} \circ m^{BAB^*} \circ i^B$ implies that i^A takes values in the center, that is, the equation $m^{AAB} \circ (i^A \circ id) = m^{ABB} \circ \tau_{1,2} \circ (i^B \circ id)$ holds. Indeed, we have

$$\begin{aligned} \langle i^A(a)b, c \rangle &= \langle i^A(a), bc \rangle = \langle m^{AAA^*}(a), b \otimes c \rangle \\ &= \langle \tau_{1,2} \circ m^{AAA^*} \circ i^A(a), b \otimes c \rangle = \langle a, cb \rangle = \langle ba, c \rangle, \end{aligned} \quad (4.15)$$

where the last equation holds since the Frobenius algebra was assumed to be symmetric.

There is a further grading by the number of punctures which are brane-labeled by \emptyset . (Recall that gluing operations never give rise to new punctures labeled by \emptyset .) In this case, representations will actually lie in triples of vector spaces (C, \mathcal{A}, W) , where W corresponds to closed string insertions which give deformations of the original operations.

5. CLOSING REMARKS

An important challenge is to understand the transition to conformal field theory from the topological field theory described in this paper as the degree zero part of the homology.

The higher degree part of the homology studied in the body of this paper is based on “exhaustive” arc families $\widetilde{Arc}(F, \beta)$ which meet each window of a brane-labeled windowed surface (F, β) . As mentioned in the Introduction, such an exhaustive family is not enough to determine

a metric on the surface unless the arc family quasi fills the surface, i.e., complementary regions are either polygons or exactly once-punctured polygons, and we shall let $\widetilde{Arc}_{\#}(F, \beta) \subseteq \widetilde{Arc}(F, \beta)$ denote the corresponding subspace.

Furthermore as in the Introduction, the subspace $\widetilde{Arc}_{\#}(F, \beta)$ is naturally identified with what is essentially Riemann's moduli space of F with one point in each boundary component. One might thus hope to describe CFT via the chains and homology groups of the quasi filling subspace $\widetilde{Arc}_{\#}(n, m)$ of the spaces $\widetilde{Arc}(n, m)$. In this setting, both the chain and homology levels must be re-examined compared to the exhaustive case studied in the body of the paper insofar as homotopies must respect $\widetilde{Arc}_{\#}(n, m)$, which in particular is not invariant under the gluing or self-gluing operations. To give a c/o-structure on the topological or chain level on $\widetilde{Arc}_{\#}(n, m)$, one can imagine using homotopies in the appropriate combinatorial compactification (see [59]) to define the gluings for compactified quasi filling arc families, or alternatively, one might proceed solely on the level of cellular chain complexes, see below.

By Lemma 4.2 for exhaustive arc families, the open sector BV operator $D^{BB} = i^{B*} \circ \Delta \circ i^B$ and its square vanish on the level of homology, while on the other hand, the other open BV-squared operator $\Delta_{sq}^B = \Delta \circ i^B \circ i^{B*} \circ \Delta$ is not zero, but rather a generator of the second homology group of $\widetilde{Arc}(F_{0,2}^1, \beta)$, where β takes value \emptyset on the boundary and value B at the puncture. In physical terms for exhaustive families, the corresponding bulk operator Δ_{sq}^B vanishes only after coupling to the boundary, i.e., $(D^{BB})^2 = 0$ yet $\Delta_{sq}^B \neq 0$.

On the other hand in the context of quasi filling arc families, Lemma 4.2 does *not* hold, and neither the operator D^{BB} nor its square now vanishes. This serves to emphasize one basic algebraic difference between exhaustive and quasi filling arc families, which are presumably required for CFT.

Furthermore, the non-vanishing of Δ_{sq}^B is reminiscent of the appearance of the Warner term in Landau-Ginzburg theory [72]. The other open sector BV-squared operator $(D^{BB})^2$ we consider is supported on the surface $F_{0,2}^1$ that is the ‘‘open square’’ of the surface $F_{0,2}^0$ which supports the Cardy equation. This gives additional credence to this point of view since it is shown in [28] that the Cardy condition is intimately related to the compensatory term required to make the action of the LG model BRST invariant.

The fact that the open sector BV-squared operator $(D^{BB})^2$ vanishes in the exhaustive case is what one would naively expect. However,

the non-vanishing of this operator in the quasi filling case might help to explain the appearance of unexpected D-branes in the LG models, cf. [28, 36, 44]. In particular in relation to Kontsevich's approach to D -branes on LG-modes (cf. [44]), one might ask if our open sector BV-squared operator Δ_{sq}^B or another "square of a BV-like operator" satisfies an equation of the form $\Delta_{sq}^B a = [U_B, a]$, or in a representation, $\Delta_{sq}^B m = U_B m$, for some operator U_B , on the level of either exhaustive or quasi filling families.

These remarks explain our attention to the chains $D_a^{A,B}$ and Δ_{sq}^B in Section 4.1.2. Although our results do not match this formulation exactly, the decomposition $\Delta_{sq}^B = (\Delta_{sq}^B)_+ + (\Delta_{sq}^B)_-$ is suggestive of a commutator equation, and the homotopy we described in Section 4.1.2 shows that each of $(\Delta_{sq}^B)_\pm$ is indeed a sort of multiplication operator, for instance, if the representing algebra is super-commutative.

In summary, the fact that the open sector BV-squared operator $(D^{BB})^2$ does not vanish in the quasi filling case and that Δ_{sq}^B does not vanish in the exhaustive case may be regarded as the statement that the boundary contribution of the BRST operator need not square to zero; rather, it may be necessary to introduce additional terms to make the entire action BRST invariant. Further analysis could give conditions on the representations of algebras over our c/o structure which can be considered physically relevant.

Although it has not been the focus in this paper, we wish to point out that there is a discretized version of G -colored c/o structures in the category of topological spaces giving G the discrete topology, and the G -colored c/o -structure then naturally descends to a G -colored c/o structure on both the chain and homology levels. We can for instance restrict the topological c/o structure on $\widetilde{Arc}(F, \beta)$ to the subspaces where each window has total weight given by a natural number.

In particular for closed strings, it can be shown [73] that there is a natural chain complex of open or relative cells, which calculates the homology of the moduli spaces, i.e., the homology of $\widetilde{Arc}_\#(F, \beta_\emptyset)$ which can be given the structure of an operad. In effect, these spaces are graded by the number of arcs in an arc family, and the corresponding filtration is preserved by the gluing operations when viewed as operations on filtered families. Now projecting to the associated graded object of the filtration, one obtains a cell level operad. Furthermore, discretizing as in the previous paragraph, one obtains actions on the tensor algebra and on the Hochschild co-chain complex of a Frobenius algebra. This discretized and filtered elaboration of the c/o structure

could give a formulation of a version of CFT purely in terms of algebraic topology. A proving ground for these considerations might be the topological LG models of [74, 75] and their orbifolds [76, 77].

Let us also mention that Thurston invented a notion of “tangential measure” (see [67]) precisely to capture the lengths as opposed to the widths of the rectangles in a measured foliation, suggesting yet another geometric aspect of this passage from TFT to CFT. It is perhaps also worth saying explicitly that an essential point of Thurston theory is that twisting about a curve accumulates in the space of *projective* measured foliations to the curve itself, and this suggests that the limit of the BV operator $\Delta(t)$ as t diverges might be profitably studied projectively in the context of Appendix B.

There is presumably a long way to go until the algebraic structure discovered here is fully understood in higher degrees on the level of homology, let alone for *compactifications* of arc complexes in the quasi filling and exhaustive cases. In the quasi filling case on the level of homology, the underlying groups supporting these operations comprise the homology groups of Riemann’s moduli spaces of bordered surfaces, which are themselves famously unknown, yet these unknown groups apparently support the modular bi-operad structure of Theorem 4.4 at least in this discretized filtered sense.

APPENDIX A: C/O STRUCTURES

A.1. The definition of a c/o-structure. Specify an object $\mathcal{O}(S, T)$ in some fixed symmetric monoidal category for each pair S and T of finite sets. A G -coloring on $\mathcal{O}(S, T)$ is the further specification of an object G in this category and a morphism $\mu : S \sqcup T \rightarrow \text{Hom}(\mathcal{O}(S, T), G)$, and we shall let $\mathcal{O}_\mu(S, T)$ denote this pair of data.

A G -colored “closed/open” or *c/o structure* is a collection of such objects $\mathcal{O}(S, T)$ for each pair of finite sets S, T together with a choice of weighting μ for each object supporting the following four operations which are morphisms in the category:

Closed gluing: $\forall s \in S, \forall s' \in S'$ with $\mu(s) = \mu'(s')$,

$$\circ_{s,s'} : \mathcal{O}_\mu(S, T) \otimes \mathcal{O}_{\mu'}(S', T') \rightarrow \mathcal{O}_{\mu''}(S \sqcup S' - \{s, s'\}, T \sqcup T');$$

Closed self-gluing: $\forall s, s' \in S$ with $\mu(s) = \mu(s')$ and $s \neq s'$,

$$\circ^{s,s'} : \mathcal{O}_\mu(S, T) \rightarrow \mathcal{O}_{\mu''}(S - \{s, s'\}, T);$$

Open gluing: $\forall t \in T, \forall t' \in T'$ with $\mu(t) = \mu'(t')$,

$$\bullet_{t,t'} : \mathcal{O}_\mu(S, T) \otimes \mathcal{O}_{\mu'}(S', T') \rightarrow \mathcal{O}_{\mu''}(S \sqcup S', T \sqcup T' - \{t, t'\});$$

Open self-gluing: $\forall t, t' \in T$ with $\mu(t) = \mu(t')$ and $t \neq t'$,

$$\bullet^{t,t'} : \mathcal{O}_\mu(S, T) \rightarrow \mathcal{O}_{\mu''}(S, T - \{t, t'\}).$$

In each case, the coloring μ'' is induced in the target in the natural way by restriction, and we assume that $S \sqcup S' \sqcup T \sqcup T' - \{s, s', t, t'\} \neq \emptyset$.

The axioms are that the operations are equivariant for bijections of sets and for bijections of pairs of sets, and the collection of all operations taken together satisfy associativity.

Notice that we use the formalism of operads indexed by finite sets rather than by natural numbers as in [64] for instance.

A.2. Restrictions. A c/o structure specializes to standard algebraic objects in the following several ways.

There are the two restrictions $(\mathcal{O}_\mu(S, \emptyset), \circ_{s,s'})$ and $(\mathcal{O}_\mu(\emptyset, T), \bullet_{\tau,\tau'})$ each of which forms a G -colored cyclic operad in the usual sense.

The spaces $(\mathcal{O}_\mu(S, T), \circ_{s,s'}, \bullet_{\tau,\tau'})$ with only the non self-gluing as structure maps form a cyclic $G \times \mathbb{Z}/2\mathbb{Z}$ -colored operad, where the $\mathbb{Z}/2\mathbb{Z}$ accounts for open and closed, e.g., the windows labeled by S are regarded as colored by 0 and the windows labeled by T are regarded as colored by 1.

If the underlying category has a coproduct (e.g., disjoint union for sets and topological spaces, direct sum for Abelian groups and linear spaces), which we denote by \coprod , then the indexing sets can be regarded as providing a grading: i.e., $(\coprod_T \mathcal{O}_\mu(S, T), \circ_{s,s'})$ form a cyclic G -colored operad graded by the sets T , and $(\coprod_S \mathcal{O}_\mu(S, T), \bullet_{\tau,\tau'})$ form a cyclic G -colored operad graded by the sets S .

A.3. Modular properties. There is a relationship between c/o structures and modular operads. Recall that in a modular operad there is an additional grading on the objects, which is additive for gluing and increases by one for self-gluing. Imposing this type of grading here, we define a $(g, \chi - 1)$ c/o-structure to be a c/o structure with two gradings (g, χ) ,

$$\mathcal{O}_\mu(S, T) = \coprod_{g \geq 0, \chi \leq 0} \mathcal{O}_\mu(S, T; g, \chi)$$

such that

- (1) $\mathcal{O}_\mu(S, T; \chi - 1) = \coprod_{g \geq 0} \mathcal{O}_\mu(S, T; g, \chi)$ is additive in $\chi - 1$ for $\bullet_{t,t'}$, and $\chi - 1$ increases by one for $\bullet^{t,t'}$; and

(2) $\mathcal{O}_\mu(S, T; g) = \coprod_{\chi \leq 0} \mathcal{O}_\mu(S, T; g, \chi)$ is additive in g for $\circ_{s, s'}$, and g increases by one for $\circ^{s, s'}$.

It follows that a $(g, \chi - 1)$ c/o structure is a modular G -colored bi-operad in the sense that the $\mathcal{O}_\mu(S, T; g)$ form a T -graded $\mathbb{R}_{>0}$ -colored modular operad* for the gluings $\circ_{s, s'}$ and $\circ^{s, s'}$, and the $\mathcal{O}_\mu(S, T; 1 - \chi)$ form an S -graded $\mathbb{R}_{>0}$ -colored modular operad* for the gluings $\bullet_{t, t'}$ and $\bullet^{t, t'}$.

A.4. Topological and Chain level c/o structures. A *topological c/o structure* is an $\mathbb{R}_{>0}$ -colored c/o structure in the category of topological spaces.

Let $Chain$ denote a chain functor together with fixed functorial morphisms for products $P : Chain(X) \otimes Chain(Y) \rightarrow Chain(X \times Y)$, viz. a chain functor of monoidal categories. The chain functors of cubical or PL chains for instance come naturally equipped with such maps, and for definiteness, let us just fix attention on PL chains. A *chain level c/o structure* is a $Chain(\mathbb{R}_{>0})$ -colored c/o-structure in the category of chain complexes of Abelian groups. Notice that if a collection $\{\mathcal{O}_\mu(S, T)\}$ forms a topological c/o structure, then we have natural maps

$$Chain(\mu) : S \sqcup T \rightarrow Hom(Chain(\mathcal{O}_\mu(S, T)), Chain(\mathbb{R}_{>0})).$$

These maps together with the induced operations make the collection $\{Chain(\mathcal{O}_\mu(S, T))\}$ into a *chain level c/o structure* by definition. The compatibility equation for self-gluings explicitly reads $Chain(\mu)(w)(a) = Chain(\mu)(w')(a)$ and for non self-gluings, we have

$$\begin{aligned} P(Chain(\mu) \otimes Chain(\mu))(w)(P(a \otimes b)) \\ = P(Chain(\mu) \otimes Chain(\mu))(w')P(a \otimes b). \end{aligned} \quad (\text{A-1})$$

It is not true that a topological c/o structure begets a $\mathbb{R}_{>0}$ -colored structure on the chain level, since the topology on $\mathbb{R}_{>0}$ is not the discrete topology. For PL chains, we may regard a generator $a \in Chain(\mathcal{O}_\mu(S, T))$ as a parameterized family, say depending on parameters s , and we shall denote such a parameterized family $a(s)$. The equation (A-1) then simply reads $\forall s, t$, we have $\mu(w)(a(s)) = \mu(w')(b(t))$.

A.5. The homology level. The coloring in a topological c/o structure is given by the contractible group $\mathbb{R}_{>0}$, and we take the coloring or grading by $Chain(\mathbb{R}_{>0})$ in the definition of chain level c/o structure.

*We impose neither $3g - 3 + |S| > 0$ nor $3(-\chi + 1) + |T| - 3 \geq 0$.

On the homology level, the grading $H_*(\mu) : H_*(\mathcal{O}_\mu(S, T)) \rightarrow H_*(\mathbb{R}_{>0})$ becomes trivial. Furthermore, it is in general not possible to push a c/o structure down to the level of homology since the gluing and self-gluing operations on the topological or chain level are defined only if certain restrictions are met. It is, however, possible in special cases to define operations by lifting to the chain level.

Lemma A.1. *Let $\mathcal{O}_\mu(S, T)$ be a topological c/o structure such that each $\mathcal{O}_\mu(S, T)$ is equipped with a continuous $\mathbb{R}_{>0}$ action ρ that diagonally acts on the $\mathbb{R}_{>0}$ grading $\mu(\rho(r)(\alpha)) = r\mu(\alpha)$. Then the homology groups $H_*(\mathcal{O}_\mu(S, T))$ form a cyclic two colored operad under non self-gluing induced by $\circ_{s,s'}$ and $\bullet_{t,t'}$.*

Proof. As in Appendix C, define a continuous flow $\psi_t^w : \mathcal{O}_\mu(S, T) \rightarrow \mathcal{O}_\mu(S, T)$ for each $w \in S \sqcup T$ by

$$\psi_t^w(\alpha) = \rho(1 - t + t/\mu(w))(\alpha);$$

thus, ψ_0^w is the identity, and $\psi_1^w(\alpha)$ has weight one on w . Given two cohomology classes $[a] \in H_*(\mathcal{O}_\mu(S, T))$ and $[b] \in H_*(\mathcal{O}_\mu(S', T'))$ represented by chains $a \in \text{Chain}(\mathcal{O}_\mu(S, T))$ and $b \in \text{Chain}(\mathcal{O}_\mu(S', T'))$ as well as two elements $(w, w') \in (S \times S') \sqcup (T \times T')$, we use the flows $\psi_t^w, \psi_t^{w'}$ to move a and b into a compatible position by a homotopy. Explicitly, defining $\tilde{a}_t = \text{Chain}(\psi_t^w)(a)$ and $\tilde{b}_t = \text{Chain}(\psi_t^{w'})(b)$, we have

$$\text{Chain}(\mu)(w)(\tilde{a}_1) = \text{Chain}(\mu')(w')(\tilde{b}_1) \equiv 1.$$

The condition (A-1) is therefore met, and we define

$$[a] \circ_{s,s'} [b] = [\text{Chain}(\circ_{s,s'})P(\tilde{a}_1, \tilde{b}_1)],$$

and likewise for $[a] \bullet_{t,t'} [b]$. Associativity of the operations follows as in Lemma C.3. \square

Proposition A.2. *Let $\mathcal{O}_\mu(S, T)$ be a topological c/o structure satisfying the hypotheses of Lemma A.1. Furthermore, suppose that for each $\mathcal{O}_\mu(S, T)$ and each choice of $w \in S \sqcup T$, there is a continuous flow $\phi_t^w : \mathcal{O}_\mu(S, T) \rightarrow \mathcal{O}_\mu(S, T)$, for $0 \leq t < 1$, such that ϕ_0^w is the identity, and for any other $w \neq w' \in S \sqcup T$ with $\mu(w')(\alpha) \leq \mu(w)(\alpha)$, there is a time $t_c = t_c(\alpha, w')$ for which $\mu(w')(\phi_{t_c}(\alpha)) = \mu(w)(\phi_{t_c}(\alpha))$, where $t_c(\alpha, w')$ depends continuously on α . Then the homology groups $H_*(\mathcal{O}_\mu(S, T))$ carry operations induced by $\circ_{s,s'}, \circ^{s,s'}$ and $\bullet_{t,t'}, \bullet^{t,t'}$.*

Moreover, given parameterized families a, b, c and letting \odot denote either operation \circ or \bullet , suppose that $(a \odot^{u,v} b) \odot^{v',w} c$ and $a \odot^{u,v} (b \odot^{v',w} c)$ are homotopic, that $(a \odot^{u,v} b) \odot_{v',w} c$ and $a \odot^{u,v} (b \odot_{v',w} c)$ are homotopic,

and that $(a \odot_{u,v} b) \odot^{v',w} c$ and $a \odot_{u,v} (b \odot^{v',w} c)$ are homotopic. Then the operations on $H_*(\mathcal{O}_\mu(S, T))$ are associative.

Finally, if the $\mathcal{O}_\mu(S, T)$ furthermore form a topological $(g, \chi - 1)$ -c/o structure, then the induced structure on homology is a modular bi-operad in the sense of §A.3.

Proof. The non-self-gluing operations are already present and associative by Lemma A.1. For the self-gluing, the descent of the operations to homology is described in analogy to Lemma C.5, and the associativity on the chain and hence homology levels of the operations finally follows from the assumed existence of the homotopies. \square

A.6. Brane-labeled c/o structures. A brane-labeled c/o structure is a c/o structure $\{\mathcal{O}_\mu(S, T)\}$ together with a fixed Abelian monoid \mathcal{P} of brane labels and for each $\alpha \in \mathcal{O}_\mu(S, T)$ a bijection $N_\alpha : T \rightarrow T$ and a bijection $(\lambda_\alpha, \rho_\alpha) : T \rightarrow \mathcal{P} \times \mathcal{P}$, such that

- (1) $\rho(t) = \lambda(N(t))$,
- (2) if $N_\alpha(t) \neq t$ and $N_{\alpha'}(t') \neq t'$

$$N_{\alpha \bullet_{t,t'} \alpha'}(N_\alpha^{-1}(t)) = N_{\alpha'}(t'), \quad N_{\alpha \bullet_{t,t'} \alpha'}(N_{\alpha'}^{-1}(t')) = N_\alpha(t)$$

$$\rho_{\alpha \bullet_{t,t'} \alpha'}(N_\alpha^{-1}(t)) = \lambda_\alpha(t) \rho_{\alpha'}(t') \quad \lambda_{\alpha \bullet_{t,t'} \alpha'}(N_\alpha(t)) = \lambda_{\alpha'}(t') \rho_\alpha(t)$$
- (3) $N_\alpha(t) \neq t$ and $N_{\alpha'}(t') \neq t'$

$$N_{\bullet_{t,t'}(\alpha)}(N_\alpha^{-1}(t)) = N_{\alpha'}(t'), \quad N_{\bullet_{t,t'}(\alpha)}(N_{\alpha'}^{-1}(t')) = N_\alpha(t)$$

$$\rho_{\alpha \bullet_{t,t'} \alpha'}(N_\alpha^{-1}(t)) = \lambda_\alpha(t) \rho_{\alpha'}(t'), \quad \lambda_{\alpha \bullet_{t,t'} \alpha'}(N_\alpha(t)) = \lambda_{\alpha'}(t') \rho_\alpha(t)$$
- (4) If either $N_\alpha(t) = t$ or $N_{\alpha'}(t') = t'$ but not both, then in the above formulas, one should substitute $N_{\alpha'}(t')$ for $N_\alpha(t)$ in the first case and inversely in the second case. (If both $N_\alpha(t) = t$ and $N_{\alpha'}(t') = t'$, then there is no equation.)

This is the axiomatization of the geometry given by open windows with endpoints labeled by right (ρ) and left (λ) brane labels, their order and orientation along the boundary components induced by the orientation of the surface, and the behaviour of this data under gluing.

For a brane-labeled c/o structure and an idempotent submonoid $\mathcal{B} \subset \mathcal{P}$ (i.e., for all $b \in \mathcal{B}, b^2 = b$), one has the $\mathcal{B} \times \mathcal{B}$ -colored substructures defined by restricting the gluings $\bullet_{t,t'}$ and $\bullet^{t,t'}$ to compatible colors $\lambda(t) = \rho(t')$.

The relevant example for us is \mathcal{B} the set of branes, $\mathcal{P} = \mathcal{P}(\mathcal{B})$ its power set with the operation of union, where $\mathcal{B} \hookrightarrow \mathcal{P}(\mathcal{B})$ is embedded by considering $B \in \mathcal{B}$ as the singleton $\{B\}$.

A.7. The c/o -structure on weighted arc families. In this subsection we give the technical details for the proof of Theorem 2.1.

First set

$$\begin{aligned} \widetilde{Arc}(S, T) &= \{(\alpha, \phi, \psi) \mid \alpha \in \widetilde{Arc}(|S|, |T|), \\ &\quad \phi : S \xrightarrow{\sim} \{\text{Closed windows}\}, \\ &\quad \psi : T \xrightarrow{\sim} \{\text{Open Windows}\}\}. \end{aligned}$$

Define the respective operations $\circ_{s,s'}, \circ^{s,s'}, \bullet_{t,t'}$ and $\bullet^{t,t'}$ to be the closed gluing and self-gluing and open gluing and self-gluing operations defined in §2, where the $\mathbb{R}_{>0}$ -coloring is the map μ given by associating the total weight of a weighted arc family to a window $w \in S \sqcup T$.

The (g, χ) -grading is given as follows. For $\alpha \in \widetilde{Arc}(S, T)$, we let g be the genus and let χ be the Euler characteristic of the underlying surface F ; if F has punctures σ , then by definition $\chi(F) = \chi(F \cup \sigma) - \#\sigma$.

Finally the brane-labeling is given by taking λ to be the brane-labeling of the left boundary point and ρ to be that of the right boundary point of the window.

APPENDIX B: c/o STRUCTURE ON MEASURED FOLIATIONS

B.1 Thurston's theory for closed surfaces. Let us specialize for simplicity in this section to a compact surface $F = F_{g,0}^0$ without boundary with $g > 1$ in order to very briefly describe Thurston's theory of measured foliations; see [66] and [67] for more detail.

A *measured foliation* of F is a one-dimensional foliation \mathcal{F} of F whose singularities are topologically equivalent to the standard p -pronged singularities of a holomorphic quadratic differential $z^{p-2}dz^2$, for $p \geq 3$, together with a transverse measure μ with no holonomy, i.e., if t_0, t_1 are transversals to \mathcal{F} which are homotopic through transversals keeping endpoints on leaves of \mathcal{F} , then $\mu(t_0) = \mu(t_1)$; μ is furthermore required to be σ -additive in the sense that if a transversal a is the countable concatenation of sub-arcs a_i sharing consecutive endpoints, then $\mu(a) = \sum_i \mu(a_i)$.

Examples arise by fixing a complex structure on F and taking for the foliation \mathcal{F} the horizontal trajectories of some holomorphic quadratic differential ϕ on F . In the neighborhood of a non-singular point of ϕ , there is a local chart $X : U \subseteq F \rightarrow \mathbb{R}^2 \approx \mathbb{C}$, so that the leaves of \mathcal{F} restricted to U are the horizontal line segments $X^{-1}(y = c)$, where c is a

constant. If the domains U_i, U_j of two charts X_i, X_j intersect, then the transition function $X_i \circ X_j^{-1}$ on $U_i \cap U_j$ is of the form $(h_{ij}(x, y), c_{ij} \pm y)$, where c_{ij} is constant and $\mathbb{C} \ni z = x + \sqrt{-1} y = (x, y) \in \mathbb{R}^2$. In these charts, the transverse measure is given by integrating $|dy|$ along transversals.

There is a natural equivalence relation on the set of all measured foliations in F , and there is a natural topology on the set of equivalence classes; see [66] and [67]. Roughly, if c is an essential simple closed curve in F transverse to \mathcal{F} , one can evaluate μ on c to determine its “geometric intersection number” with \mathcal{F}_μ ; each homotopy class $[c]$ of such curve has a representative minimizing this intersection number, and this minimum value is called the *geometric intersection number* $i_{\mathcal{F}_\mu}[c]$ of $[c]$ and \mathcal{F}_μ . This describes a mapping $\mathcal{F}_\mu \mapsto i_{\mathcal{F}_\mu}$ from the set of measured foliations to the function space $\mathbb{R}_{\geq 0}^{\mathcal{S}(F)}$, where $\mathcal{S}(F)$ is the set of all homotopy classes of essential simple closed curves in F , and the function space is given the weak topology. The equivalence classes of measured foliations can be described as the fibers of this map, and the topology as the weakest one so that each $i_{\mathcal{F}_\mu}[c]$ is continuous. (It does not go unnoticed that this effectively “quantizes the observables corresponding to closed curves”.) Both the equivalence relation and the topology can be described more geometrically; see [66] and [67]. In fact, the equivalence relation on measured foliations is generated by isotopy and “Whitehead moves”, which are moves on measured foliations dual to those depicted in Figure 13a.

There is thus a space $\mathcal{MF}(F)$ of measured foliation classes on F embedded in $\mathbb{R}_{\geq 0}^{\mathcal{S}(F)}$. Each measured foliation (class) \mathcal{F}_μ determines an underlying *projective measured foliation (class)*, where one projectivizes μ by the natural action of $\mathbb{R}_{>0}$ on measures and obtains the space of *projective measured foliations* $\mathcal{PF}(F)$ as the quotient of $\mathcal{MF}(F)$ by this action.

Remark It is necessary later to be a bit formal about the empty foliation in F , which we shall denote by 0 and identify with the zero functional in $\mathbb{R}_{>0}^{\mathcal{S}(F)}$. Let $\mathcal{MF}^+(F)$ denote $\mathcal{MF}(F)$ together with 0 topologized so that a neighborhood of 0 is homeomorphic to the cone from 0 over $\mathcal{PF}(F)$. In other words, $\mathcal{PF}(F)$ is the projectivization of the $\mathbb{R}_{>0}$ -space $\mathcal{MF}^+(F) - \{0\} \subseteq \mathbb{R}_{\geq 0}^{\mathcal{S}(F)}$.

Projective measured foliations were introduced by William Thurston in the 1970’s as a tool for studying the degeneration of geometric structures in dimensions two and three as well as for studying the dynamics of homeomorphisms in two dimensions.

If $[d] \in \mathcal{S}(F)$, then there is a corresponding functional $i_{[d]} \in \mathbb{R}_{\geq 0}^{\mathcal{S}(F)}$, where $i_{[d]}[c]$ is the minimum number of times that representatives c and d intersect, counted *without sign*, the “geometric intersection number”. In effect, the space $\mathcal{PF}(F)$ forms a completion of $\mathcal{S}(F)$; more precisely, the projective classes of $\{i_{[d]} \cdot : [d] \in \mathcal{S}(F)\}$ are dense in the projectivization of $\mathcal{MF}^+(F) - \{0\}$.

Furthermore, $\mathcal{PF}(F)$ is homeomorphic to a piecewise-linear sphere of dimension $6g - 7$. This sphere compactifies the usual Teichmüller space of F so as to produce a closed ball of dimension $6g - 6$ upon which the usual mapping class group $MC(F)$ of F acts continuously. For instance, one immediately obtains non-trivial results from the Lefschetz fixed point theorem.

Thurston’s boundary does not descend in any tractable geometric sense to the quotient by $MC(F)$ since the $MC(F)$ -orbit of any non-separating curve is dense in $\mathcal{PF}(F)$. The quotient $\mathcal{PF}(F)/MC(F)$ is thus dramatically non-Hausdorff.

B.2 Measured foliations and c/o structure. Unlike the body of the paper, where we strived to include only those combinatorial aspects which are manifest for physical interactions of strings, here we briefly describe a more speculative mathematical extension of the foregoing theory in the context of general measured foliations in a windowed surface $F = F_g^s(\delta_1, \dots, \delta_r)$ with windows W , set σ of punctures of cardinality $s \geq 0$, and set δ of distinguished points on the boundary. Let β denote a brane-labeling on F , and set $\delta(\beta) = \{g \in \delta : \beta(g) \neq \emptyset\}$.

A measured β -foliation of F is a measured foliation \mathcal{F}_μ in the usual sense of a closed subsurface (perhaps with boundary or punctures) of F so that leaves of \mathcal{F} are either simple closed curves (which may be neither contractible nor puncture-parallel nor boundary-parallel), bi-infinite lines, or line segments with endpoints in $\cup W$ which are not boundary-parallel in $F - \delta(\beta)$.

We shall furthermore require that \mathcal{F}_μ has *compact support* in the sense that its leaves are disjoint from a neighborhood of $\delta \cup \sigma$. In particular, \mathcal{F} is not permitted to have leaves that are asymptotic to $\delta \cup \sigma$.

There is again a natural equivalence relation on the set of all measured β -foliations of compact support in F and a natural topology on the space of equivalence classes induced by geometric intersection numbers with curves as before and now also with embedded arcs connecting

points of $\delta(\beta)$. Let

$$\mathcal{MF}_0(F, \beta)$$

denote the corresponding space of measured β -foliations of compact support.

We shall go a step further and allow puncture- and boundary-parallel curves (for instance, in order to capture that part of the foliation possibly discarded in the body of the paper in open self-gluing): a *non-negative collar weight* on a windowed surface is a $\mathbb{R}_{\geq 0}$ -function defined on σ , and one imagines an annulus of width given by the collar weight foliated by puncture- or boundary-parallel curves. Let

$$\widetilde{\mathcal{MF}}_0^{\geq 0}(F, \beta) \approx \mathcal{MF}_0(F, \beta) \times \mathbb{R}_{\geq 0}^s$$

denote the corresponding space of measured β -foliations of compact support together with a non-negative collar weight.

It is nearly a tautology that any partial measured foliation of compact support with non-negative collar weight decomposes uniquely into a disjoint union of its “minimal” sets, which are one of the following: a band of leaves parallel to an arc properly embedded F with endpoints in $\cup W$; an annulus in F foliated by curves parallel to the core of the annulus; a foliation disjoint from the boundary with no closed leaves.

Finally, define

$$\widetilde{\mathcal{MF}}_0^{\geq 0}(n, m, s) = \left(\bigsqcup_F \bigsqcup_{\beta} \widetilde{\mathcal{MF}}_0^{\geq 0}(F) \right) / \sim,$$

where the outer disjoint union is over all homeomorphism classes of windowed surfaces F with $s \geq 0$ punctures, $n \geq 0$ closed windows, and $m \geq 0$ open windows with $m + n + s > 0$, and the inner disjoint union is over all brane-labelings β on F ; the equivalence relation \sim on the double disjoint union is generated by the following identifications: If \mathcal{F}_μ is a partial measured foliation of F and ∂ is a boundary component of F containing no active windows, then we collapse ∂ to a new puncture brane-labeled by the union of the labels on ∂ to produce in the natural way a measured foliation $\mathcal{F}'_{\mu'}$ of another brane-labeled windowed surface F' , and we identify \mathcal{F}_μ in F with $\mathcal{F}'_{\mu'}$ in F' in $\widetilde{\mathcal{MF}}_0^{\geq 0}(n, m, s)$ in the natural way. In particular, each equivalence class has a representative measured foliation \mathcal{F}_μ in some well-defined topological type of windowed surface F , where every boundary component of F has at least one active window for \mathcal{F}_μ .

The gluing operations in Section 2 extend naturally to corresponding operations on the objects $\widetilde{\mathcal{MF}}_0^{\geq 0}(n, m, s)$, where we assume that the

boundary component containing each closed window is framed. In each case, we may also glue inactive windows to inactive windows in analogy to Figure 5. Furthermore, rather than discard the part of \mathcal{F}_3 (in the notation of Section 2) that is not a band of arcs, we discard only those annuli foliated by null homotopic simple closed curves as may arise from closed gluing or self-gluing.

We know of no physical interpretation for the minimal sets of a measured foliation other than bands of arcs as in the body of the paper. Furthermore, the quotient of $\widetilde{\mathcal{M}F}_0^{\geq 0}(F, \beta)$ by $MC(F)$ is typically non-Hausdorff, yet contains the Hausdorff subspace $\widetilde{Arc}(F, \beta)$ studied in the body of the paper. (The natural appearance of a non-Hausdorff space as part of this theory does not go unnoticed.)

Geometrically, minimal sets that are not bands of arcs “serve to mitigate other interactions” for the simple reason that a foliated band of arcs cannot cross an annulus which is foliated by circles parallel to the core of the annulus.

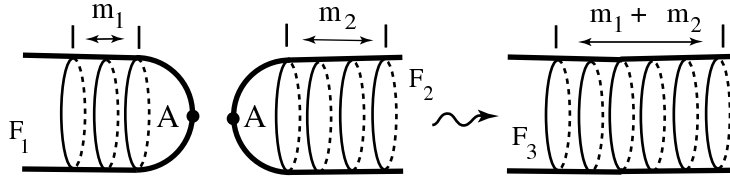

Figure B.1 Unpinching and self-unpinching.

There are also in the current context two further operations of “unpinching” and “self-unpinching” which are geometrically natural and are illustrated in Figure B.1.

In the wider context of this appendix, minimal sets that are not bands play three roles: they arise naturally from the gluing and self-gluing operations so as to mitigate other interactions; they arise from certain cases of open self-gluing as annuli foliated by puncture-parallel curves, which themselves interact via unpinching; and they can be included as *a priori* data which is invisible to the *c/o* structure on $\widetilde{Arc}(n, m)$ yet to which this *c/o* structure contributes via gluing and self-gluing.

Theorem 1.2 holds essentially *verbatim* in the current context (this was the original purview) and describes the indecomposables as well as global coordinates. There is, however, a more elegant parametrization from [68], which should provide useful variables for quantization of the foregoing theory as closely related coordinates did in Kashaev’s

quantization of decorated Teichmüller space [69]. This parametrization arises by relaxing non-negativity of collar weights as follows.

Construct the space $\widetilde{\mathcal{MF}}_0(F, \beta)$ in analogy to $\widetilde{\mathcal{MF}}_0^{\geq 0}(F, \beta)$ but allow the collar weight on any puncture to be any real number; one imagines either a foliated annulus as before if the collar weight is non-negative or a kind of “deficit” foliated annulus if the collar weight is negative.

To explain the parametrization, let us fix a space-filling brane-label β_A for simplicity, where $A \neq \emptyset$, and choose a generalized pants decomposition Π of F . Inside each complementary region to Π insert a branched one-submanifold as illustrated in Figure B.2a, and combine these in the natural way to get a branched one-submanifold τ properly embedded in F . Inside each $F_{0,(3)}^0$ or $F_{0,1}^1$, there is a small triangle, as illustrated, and the edges of these triangles are called the *sectors* of τ . Define a *measure* on τ to be the assignment of a real number to each sector of τ subject to the constraints that the “coupling equations” hold for each edge of Π ; namely, $a = b$ on $F_{0,1}^1$ and $a + b = c + d$ on $F_{0,(4)}^0$ as illustrated in Figure B.2b

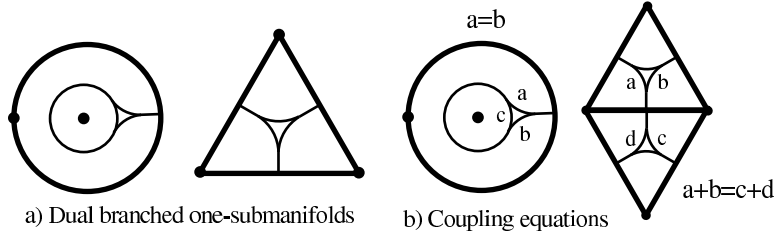

Figure B.2 Dual branched one-submanifolds and coupling equations.

One result from [68] is that the vector space of measures on τ is isomorphic to $\widetilde{\mathcal{MF}}_0(F, \beta_A)$, and there is a canonical fiber bundle

$$\widetilde{\mathcal{MF}}_0(F, \beta_A) \rightarrow \mathcal{MF}_0^+(F, \beta_A),$$

where the fiber over a point is given by the set of all collar weights on F , and $\mathcal{MF}_0^+(F, \beta_A)$ denotes the space of measured β_A -foliations of compact support on F completed by the empty foliation as in the Remark in the previous section. Indeed, each puncture p corresponds to a closed edge-path on τ which traverses a collection of sectors, and given a measure μ on τ , the collar weight c_p of p is the minimum value that μ takes on these sectors; modify the original measure μ on τ by taking $\mu'(b) = \mu(b) - c_p$ if b is contained in the closed edge-path for p .

Since μ satisfies the coupling equations, μ' extends uniquely to a well-defined non-negative measure on τ , which describes a (possibly empty) element of $\mathcal{MF}_0^+(F, \beta_A)$ by gluing together bands as before, one band for each edge of τ on which $\mu' > 0$. A PL section of this bundle gives a PL embedding of the PL space $\mathcal{MF}_0^+(F, \beta_A)$ into the vector space $\widetilde{\mathcal{MF}}_0(F, \beta_A)$.

Another result from [68] for $r = 0$ and $s \neq 0$ is that the Weil-Petersson Kähler two-form on Teichmüller space extends continuously to the natural symplectic structure given by Thurston on the space of measured foliations of compact support.

APPENDIX C: FLOWS ON $\widetilde{Arc}(n, m)$

In this appendix, we shall define and study useful flows on $\widetilde{Arc}(n, m)$, two flows for each window. Fix a brane-labeled windowed surface (F, β) with distinguished window w . If $\alpha \in \widetilde{Arc}(F, \beta)$, then we shall now denote the α -weight of w simply by $\alpha(w)$.

The first flow ψ_t^w is relatively simple to define:

$$\psi_t^w(\alpha) = (1 - t + t/\alpha(w)) \cdot \alpha,$$

where the multiplication $x \cdot \alpha$ scales all the weights of α by the factor x ; thus, ψ_0^w is the identity, and $\psi_1^w(\alpha)(w) = 1$. This flow ψ_t^w provides a rough paradigm for the more complicated one to follow, and it alone is enough to define open and closed *non self-gluing* as follows: given families a in $\widetilde{Arc}(F_1, \beta_1)$ and b in $\widetilde{Arc}(F_2, \beta_2)$, define

$$a \odot_{v,w} b = \begin{cases} \psi_1^v(a) \circ_{v,w} \psi_1^w(b), & \text{if } u, v \text{ are closed windows;} \\ \psi_1^v(a) \bullet_{v,w} \psi_1^w(b), & \text{if } u, v \text{ are open windows.} \end{cases}$$

where v, w are respective distinguished windows of F_1, F_2 . The gluing on the right is defined on the chain level provided v, w are either both open or both closed since $\psi_1^v(a)(v) \equiv 1 \equiv \psi_1^w(b)(w)$.

Lemma C.3. *The operations $\odot_{v,w}$ on chains descend to well-defined operations on homology classes. Furthermore, suppose that a, b, c are respective parameterized families in the brane-labeled surfaces (F_i, β_i) , for $i = 1, 2, 3$, with distinguished windows u in F_1 , $v \neq v'$ in F_2 , and w in F_3 , where $\{u, v\}$ and $\{v', w\}$ each consists of either two open or two closed windows. Then there is a canonical homotopy between $(a \odot_{u,v} b) \odot_{v',w} c$ and $a \odot_{u,v} (b \odot_{v',w} c)$.*

Proof. To be explicit in this context of parameterized families, to say that two families a_0, a_1 in $\widetilde{Arc}(F_1, \beta_1)$ of degree k are homologous means that there is a degree $k+1$ family A in $\widetilde{Arc}(F_1, \beta_1)$ so that the boundary of the parameter domain for A decomposes into two sets I_0, I_1 with disjoint interiors so that A restricts to a_i on I_i , for $i = 0, 1$. It follows that $\psi_1^v A \circ_{v,w} \psi_1^w b_0$ gives the required homology between $a_0 \circ_{v,w} b_0$ and $a_1 \circ_{v,w} b_0$, for any family b_0 in $\widetilde{Arc}(F_2, \beta_2)$. The analogous argument applies to two homologous families b_0, b_1 in $\widetilde{Arc}(F_2, \beta_2)$, so $a_1 \circ_{v,w} b_0$ is likewise homologous to $a_1 \circ_{v,w} b_1$. Thus, $a_0 \circ_{v,w} b_0$ and $a_1 \circ_{v,w} b_1$ are indeed homologous, completing the proof that the operations are well-defined on homology.

As for the canonical homotopy, we claim that $(a \circ_{u,v} b) \circ_{v',w} c$ and $a \circ_{u,v} (b \circ_{v',w} c)$ represent the same projective class. Specifically, let F_{12} denote the surface containing $a \circ_{u,v} b$, let F_{23} denote the surface containing $b \circ_{v',w} c$, and let F_{123} denote the common surface containing $(a \circ_{u,v} b) \circ_{v',w} c$ and $a \circ_{u,v} (b \circ_{v',w} c)$ with its induced brane-label β_{123} . Corresponding to $\{u, v\}$ in F_{123} there is either a properly embedded arc (if u, v are open) or perhaps a simple closed curve (if u, v are closed or under certain circumstances if u, v are open), and likewise corresponding to $\{v', w\}$, there is an arc or curve. In the family $(a \circ_{u,v} b) \circ_{v',w} c$, the latter arc or curve has transverse measure constant equal to one while the former arc or curve has some constant transverse measure x ; in the family $a \circ_{u,v} (b \circ_{v',w} c)$, the former arc or curve has transverse measure constant equal to one while the latter arc or curve has some constant transverse measure y . It follows from the definition of composition $\circ_{v,w}$ that $y = 1/x$ and

$$x \cdot [a \circ_{v,w} (b \circ_{v',w} c)] = (a \circ_{v,w} b) \circ_{v',w} c,$$

where again \cdot denotes the natural scaling action of $\mathbb{R}_{>0}$ on arc families in F_{123} . The required homotopy Ψ_t , for $0 \leq t \leq 1$, is finally given by

$$(1 + t(x - 1)) \cdot [a \circ_{v,w} (b \circ_{v',w} c)].$$

□

Turning now to preparations for the second more intricate flow for self-gluing, suppose that F is a windowed surface with brane-labeling β . If $\alpha \in Arc(F, \beta)$ and w is some specified window of F , then the bands of α that meet w can be grouped together as follows: consecutive bands along w that connect w to a common window w' are grouped together into the w -bands of α at w , where consecutive w -bands are not

permitted to share a common endpoint other than w in the obvious terminology. In particular, for any window w' of F , there is the collection of w -bands of α with endpoints w and w' . Still more particularly, there are the w -bands that have both endpoints at w , which are called the *self bands* of w .

Fix windows w and $w' \neq w$ of F and assume that $\alpha \in \widetilde{Arc}(F, \beta)$ satisfies $\alpha(w) > \alpha(w')$. We shall define a flow ϕ_t^w , for $-1 \leq t < 1$, so that at a certain first critical time $t_c < 1$, we have equality $\phi_{t_c}^w(w) = \phi_{t_c}^w(w')$.

The flow ϕ_t^w is defined in two stages for $-1 \leq t \leq 0$ and for $0 \leq t < 1$, and the first stage is relatively easy to describe: leave alone the w -bands of α other than the self bands, and scale the weight of each self band by the factor $|t|$. Thus, ϕ_{-1}^w is the identity, and $\phi_0^w(\alpha)$ has no self bands at w . Furthermore, $\phi_t^w(\alpha)(w)$ is monotone decreasing, and $\phi_t^w(\alpha)(u)$ is constant independent of t for any $u \neq w$.

If α has only self bands at w , then $\phi_0^w(\alpha)(w) = 0$ (so the flow is defined in $\widetilde{Arc}(F, \beta)$ only for $-1 \leq t < 0$), and there is thus some smallest $t_c < 0$ so that $\phi_{t_c}^w(\alpha)(w) = \phi_{t_c}^w(\alpha)(w')$. More generally, even if α has non self bands at w , it may happen that there is some smallest $t_c \leq 0$ so that $\phi_{t_c}^w(\alpha)(w) = \phi_{t_c}^w(\alpha)(w')$. This completes the definition of the first stage of the flow up to the point that there are no self bands at w .

If there is no such $t_c \leq 0$, then we continue to define the second stage of the flow ϕ_t^w for $0 \leq t < 1$ in the absence of self bands as follows.

If there is only one w -band of weight a , then ϕ_t^w is defined as in Figure C.1, where the darkened central part of the original foliated rectangle corresponding to this w -band is left alone, and the outer white part of the foliation is erased, i.e., leaves are removed from the foliation.

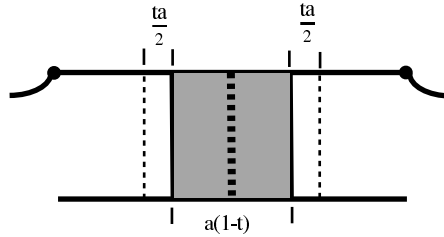

a) One w -band, for $0 \leq t < 1$.

Figure C.1 The flow ϕ_t^w for one w -band.

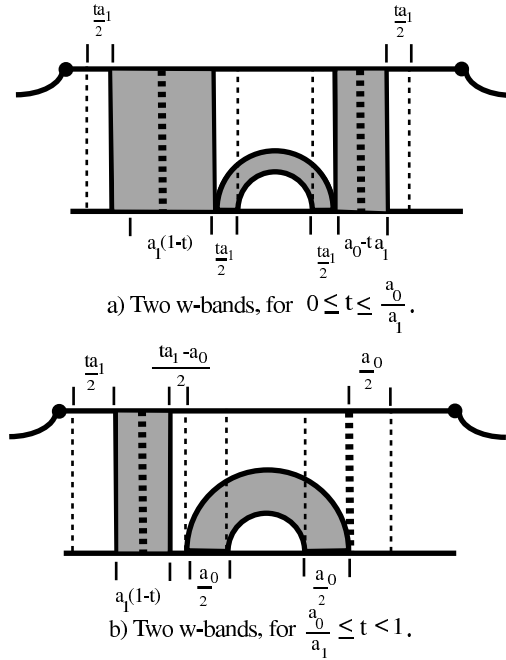

Figure C.2 The flow ϕ_t^w for two w-bands.

More interesting is the case that there are two w -bands, which is illustrated in Figure C.2. In between the two bands, we surger together arcs preserving measure in the manner indicated. Since the w -bands are consecutive and there are no self bands at w , the resulting arcs must connect distinct windows, hence must be essential and moreover cannot be a self band at any window. We erase leaves from the other sides of the two bands as before. Letting $a_0 < a_1$ denote the weights of the two w -bands, there is a critical time $t = a_0/a_1$ when there is a unique w -band. The flow before the critical time is illustrated in Figure C.2a and after it in Figure C.2b.

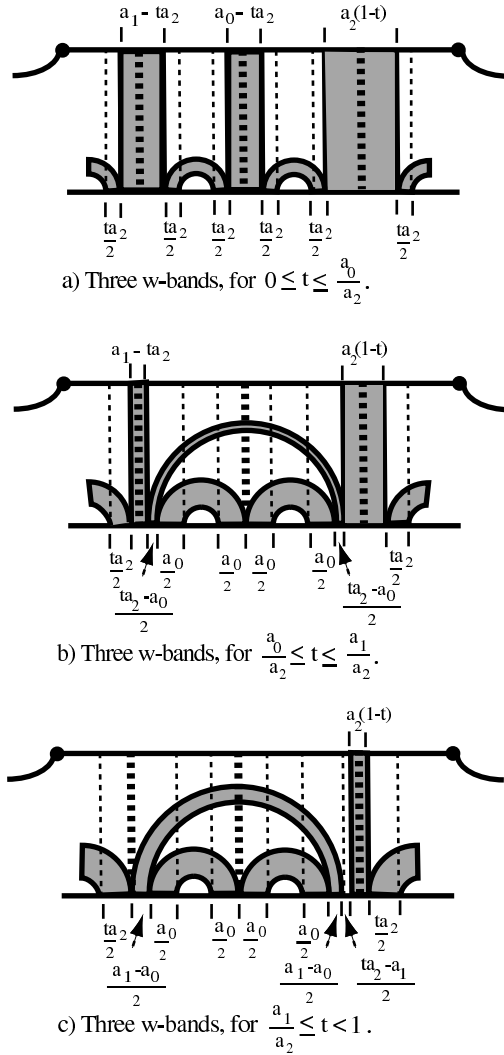

Figure C.3 The flow ϕ_t^w for three or more w-bands, first case.

For three or more bands, there are two essential cases. Let us fix three consecutive w -bands b_1, b_2, b_3 of respective weights a_1, a_0, a_2 , where $a_0 \leq a_1 \leq a_2$, i.e., b_2 is of minimum weight and $b_1 \leq b_3$. It may happen that b_1 and b_3 do not share an endpoint other than w , and in this case, the flow is defined as illustrated in Figure C.3. There are two critical times $t = a_0/a_1, a_1/a_2$, at each of which the number of w -bands is decreased by one.

Figure C.4 illustrates the case that b_1 and b_3 do share an endpoint other than w . At the first critical time $t = a_0/a_1$, the number of bands is in effect decreased by two since the two bands must now be combined

to one; at the second critical time $t = a_1/a_2$, there is then a transition from two-bands-as-one to a single band.

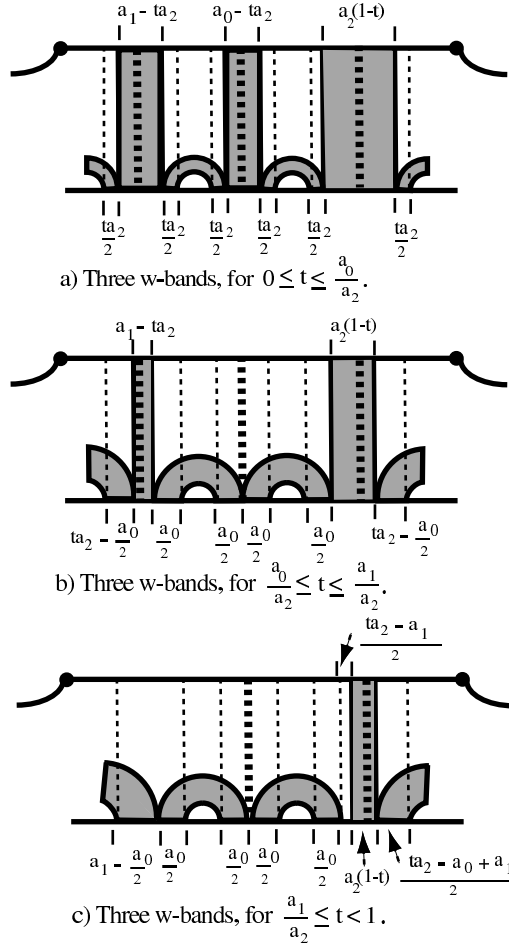

Figure C.4 The flow ϕ_t^w for three or more w-bands, second case.

Now generalizing Figures C.3 and C.4 in the natural way to consecutive w -bands, this completes the definition of the flow ϕ_t^w . Notice that additive relations among the weights of the w -bands can lead to modifications of the evolution, but in all cases, there are two basic types of critical times when a band becomes exhausted: either the newly consecutive w -bands share an endpoint other than w so must be combined to a single w -band, or they do not and one adds a new band of surgered arcs which does not meet w .

By definition, ϕ_0^w is the identity. Furthermore for any $\alpha \in \widetilde{Arc}(F, \beta)$ by construction, we have $\phi_t^w(\alpha)(w)$ tending to zero as t tends to one.

In fact, consideration of the formulas in Figures C.1-C.4 shows that $d/dt \phi_t^w(\alpha)(w) = -\phi_t^w(\alpha)(w)$, so the decay to zero is exponential in t .

Lemma C.4. *Fix a brane-labeling β on a windowed surface F with respective closed and open windows S and T , fix a window w of F , and let $\widetilde{Arc}_w(F, \beta) \subseteq \widetilde{Arc}(F, \beta)$ denote the subspace corresponding to arc families α that have no self bands at w . Then there is a continuous piecewise-linear flow*

$$\phi_t^w : \widetilde{Arc}_w(F, \beta) \rightarrow \widetilde{Arc}_w(F, \beta), \text{ for } 0 \leq t < 1,$$

such that ϕ_0^w is the identity, and for any other $w \neq w' \in S \sqcup T$ with $\alpha(w') \leq \alpha(w)$, there is a first time $t_c = t_c(\alpha) < 1$ for which

$$\phi_{t_c}^w(\alpha)(w) = \phi_{t_c}^w(\alpha)(w'),$$

where $t_c(\alpha)$ depends continuously on α .

Proof. Suppose that $w \neq w'$ is another window of F , and consider the w' -bands of α . If there is a w' -band with an endpoint distinct from w , then $\phi_t^w(\alpha)(w')$ is bounded below uniformly in t since such a w' -band is undisturbed by the flow ϕ_t^w by definition. Furthermore, suppose that two consecutive w -bands have respective other endpoints w' and $w'' \neq w$. After an instant of time, the flow combines these bands to produce a w' -band as in the previous sentence. It follows that if $\alpha(w') \leq \alpha(w)$, then there is indeed some critical first time $t_c = t_c(\alpha) = t_c(\alpha, w')$ so that $\phi_{t_c}^w(\alpha)(w) = \phi_{t_c}^w(\alpha)(w')$.

As for continuity, a neighborhood in $\widetilde{Arc}(F, \beta)$ of a weighting μ on an arc family α is a choice of maximal arc family $\alpha' \supseteq \alpha$ together with an open set V of weightings μ' on α' so that $\mu' \in V$ restricts to a neighborhood of μ , and values of μ' on $\alpha' - \alpha$ are all bounded above by some ε . We may choose a maximal arc family α' with no self bands at w since α has no self bands at w . Adding arcs in $\alpha' - \alpha$ to α cannot decrease the number of w -bands. Furthermore, if a_{max} is the maximum value of α on a w -band, then in time $t > \varepsilon/a_{max}$, the corresponding bands of arcs in α' are erased or combined by $\phi_t^w(\alpha')$. Continuity of the flow follows from these facts.

Continuity of the critical time function also follows from these facts and the following considerations. The number of w -bands for $\phi_t^w(\alpha)$ is a non-increasing function of t , so either $\phi_{t_0}^w(\alpha)(w) = \phi_{t_0}^w(\alpha)(w')$ for some $t_0 < t$, or there is a unique w -band at time t . In the latter case, either this w -band has its other endpoint distinct from w' , so $\phi_t^w(\alpha)(w)$

is exponentially decreasing in t while $\phi_t^w(\alpha)(w')$ is constant, or this w -band has its other endpoint at w' . In the latter case, either this w -band is not the unique w' -band, so $\phi_t^w(w') > \phi_t^w(\alpha)(w)$ and these quantities must have therefore agreed at some time preceding t , or there is a unique w -band and a unique w' -band connecting w and w' . In the latter case, $\phi_t^w(\alpha)(w') = \phi_t^w(\alpha)(w)$ for all time after t . \square

As before, suppose that $a = a(s)$ is a parameterized family in $\widetilde{Arc}(F_1, \beta_1)$ and $b = b(t)$ is a parameterized family in $\widetilde{Arc}(F_2, \beta_2)$, where v, w are respective distinguished windows of F_1, F_2 . Let

$$\begin{aligned} u(s, t) &= \begin{cases} v, & \text{if } a(s)(v) \geq b(t)(w); \\ w, & \text{if } a(s)(v) < b(t)(w); \end{cases} \\ d(s, t) &= \begin{cases} a(s), & \text{if } a(s)(v) \geq b(t)(w); \\ b(t), & \text{if } a(s)(v) < b(t)(w), \end{cases} \end{aligned}$$

and finally define

$$a \odot^{v,w} b = \begin{cases} \phi_{t_c}^{u(s,t)} a(s) \circ^{v,w} \phi_{t_c}^{u(s,t)} b(t), & \text{if } v, w \text{ are closed windows;} \\ \phi_{t_c}^{u(s,t)} a(s) \bullet^{v,w} \phi_{t_c}^{u(s,t)} b(t), & \text{if } v, w \text{ are open windows,} \end{cases}$$

where $t_c = t_c(d(s, t))$ is the critical first time when the flow $\phi_{t_c}^{u(s,t)}$ achieves $a(s)(v) = b(t)(w)$ so that gluing is possible.

Lemma C.5. *The operations $\odot^{v,w}$ on chains descend to well-defined operations on homology classes. Furthermore, suppose that a, b, c are respective parameterized families in the brane-labeled surfaces (F_i, β_i) , for $i = 1, 2, 3$, with distinguished windows u in F_1 , $v \neq v'$ in F_2 , and w in F_3 , where $\{u, v\}$ and $\{v', w\}$ each consists of either two open or two closed windows. Then there is a canonical homotopy between $(a \odot^{u,v} b) \odot^{v',w} c$ and $a \odot^{u,v} (b \odot^{v',w} c)$.*

Proof. That the operations are well-defined on the level of homology follows in analogy to the previous case Lemma C.3, and it remains only to describe the canonical homotopies. To this end in addition to the surfaces F_{12} and F_{23} respectively containing $a \odot^{u,v} b$ and $b \odot^{v',w} c$, as well as the surface F_{123} containing both $(a \odot^{u,v} b) \odot^{v',w} c$ and $a \odot^{u,v} (b \odot^{v',w} c)$, we must introduce another auxiliary surface F defined as follows. Among the two operations $\odot^{u,v}$ and $\odot^{v',w}$, suppose that $\kappa = 0, 1, 2$ of

the operations are closed string self gluings. The auxiliary surface F is homeomorphic to F_{123} except that it has 2κ additional punctures, which we imagine as lying in a small annular neighborhood of the corresponding curve in F_{123} with one new puncture on each side of the curve.

In this surface F with punctures σ and distinguished points δ on the boundary, we shall consider collections of arc families somewhat more general than before. Specifically, we shall now allow arcs to have one or both of their endpoints in $\delta \cup \sigma$. Arc families are still defined rel $\delta \cup \sigma$ as before, and the geometric realization of the corresponding partially ordered set is the space within which we shall define the required homotopy. Arcs with endpoints at $\delta \cup \sigma$ are called “special” arcs, and there is a homotopy that simply scales their weights to zero to produce an arc family in the usual sense in F_{123} ; our homotopies will be described in this augmented arc complex of F taking care to make sure that this projection to F_{123} lies in $\widetilde{Arc}(F_{123}, \beta_{123})$, i.e., every window has positive weight for the projection, where β_{123} is the brane-labeling induced on F_{123} from the given data.

We modify the constructions of Figure C.1-4 in one manner for open string self-gluing and in another manner for closed string self-gluing. For the former in the second stage of the homotopy, instead of erasing the outermost edges of the one or two outermost w -bands, let us instead keep these arcs and run them as special arcs to the nearby points of δ in the natural way. For closed gluing, we employ the additional punctures of F and instead of erasing the outermost edges of the one or two outermost w -bands, we instead run them as special arcs to the nearby additional punctures in the natural way.

There is thus a modified flow for the augmented arc families with the advantage that only the weight of the window w changes under the modified flow, and therefore the modified flows corresponding to different windows commute. There is furthermore a modified operation defined in analogy to $\odot^{v,w}$ using the modified flow. Because the modified flows of different windows commute, the modified expressions $(a \odot^{u,v} b) \odot^{v',w} c$ and $a \odot^{u,v} (b \odot^{v',w} c)$ agree exactly.

Finally, there are the special bands that arise from the operation $\odot^{u,v}$, and then there are the special bands that arise from the operation $\odot^{v',w}$. Scaling the former to zero projects to one order of composition, and scaling the latter to zero projects to the other order of composition. This establishes the asserted homotopies. \square

Corollary C.6. *For any brane-labeled windowed surface (F, β) , the space $\widetilde{\text{Arc}}(F, \beta)$ supports the collection $\{\phi_t^w : w \text{ is a window of } F\}$ of pairwise commuting flows.*

Proof. As in the previous proof, scaling to zero first the special bands of one modified flow and then scaling to zero the special bands of the other modified flow projects to one order of composition of flows on $\widetilde{\text{Arc}}(F, \beta)$, while scaling to zero in the other order produces the other order of composition. \square

Lemma C.7. *Under the hypotheses and notation of Lemma C.5, there is a canonical homotopy between $(a \odot^{u,v} b) \odot_{v',w} c$ and $a \odot^{u,v} (b \odot_{v',w} c)$ and a canonical homotopy between $(a \odot_{u,v} b) \odot_{v',w} c$ and $a \odot_{u,v} (b \odot_{v',w} c)$*

Proof. As in Lemma C.5, there is an auxiliary surface with arc families augmented by special arcs. Again, modified flows give rise to modified operations so that the asserted pairs are projectively equivalent. Finally, scaling with homotopies as in Lemma C.3 completes the proof. \square

ACKNOWLEDGMENTS

Both authors are happy to acknowledge the kind support of the Max-Planck Institute for Mathematics (Bonn) during the Summer of 2005, where and when this work began, and particularly the warm hospitality of Yuri and Xenia Manin. It is also a pleasure for RCP to thank his colleagues Clifford Johnson and Tobias Ekholm for especially helpful discussions.

REFERENCES

- [1] M. Atiyah. *Topological quantum field theories*. Inst. Hautes Études Sci. Publ. Math. (1988) 175–186.
- [2] R. Dijkgraaf. *A geometric approach to two dimensional conformal field theory*. Ph.D. thesis, University of Utrecht (1989).
- [3] J. Kock. *Frobenius Algebras and 2D Topological Quantum Field Theories*. London Mathematical Society Student Texts 59. Cambridge University Press, Cambridge, 2004.
- [4] J. L. Cardy and D. C. Lewellen. *Bulk and boundary operators in conformal field theory*. Phys. Lett., No. 3 (1991) 274–278,
- [5] D. C. Lewellen. *Sewing constraints for conformal field theories on surfaces with boundaries*. Nucl. Phys., No. 3 (1992) 654–682,

- [6] C. I. Lazaroiu, *On the structure of open-closed topological field theory in two dimensions*, Nucl. Phys. B **603**, 497 (2001).
- [7] G. B. Segal. *Topological structures in string theory*. Phil. Trans. Roy. Soc. Lond., No. 1784 (2001) 1389–1398.
- [8] G. Moore and G. B. Segal. *Lectures on Branes, K-theory and RR Charges*. Lecture notes from the Clay Institute School on Geometry and String Theory held at the Isaac Newton Institute, Cambridge, UK, available at <http://www.physics.rutgers.edu/~gmoore/clay1/clay1.html>, and from the ITP Miniprogram ‘The Duality Workshop’ at Santa Barbara available at <http://online.itp.ucsb.edu/online/mp01/moore1/> (2001–2002)
- [9] A. D. Lauda and H. Pfeiffer. *Open-closed strings: Two-dimensional extended TQFTs and Frobenius algebras*. Preprint math.AT/0510664
- [10] E. Witten, *Noncommutative Geometry And String Field Theory*. Nucl. Phys. B **268**, 253 (1986).
- [11] T. Kugo, H. Kunitomo and K. Suehiro, *Nonpolynomial Closed String Field Theory*, Phys. Lett. B **226**, 48 (1989).
- [12] M. Saadi and B. Zwiebach, *Closed String Field Theory From Polyhedra*. Annals Phys. **192**, 213 (1989).
- [13] B. Zwiebach, *Closed string field theory: Quantum action and the B-V master equation*. Nucl. Phys. B **390**, 33 (1993)
- [14] B. H. Lian and G. J. Zuckerman, *New perspectives on the BRST algebraic structure of string theory*. Commun. Math. Phys. **154**, 613 (1993).
- [15] B. H. Lian and G. J. Zuckerman, *Some Classical And Quantum Algebras*. Preprint hep-th/9404010.
- [16] E. Witten, *On The Structure Of The Topological Phase Of Two-Dimensional Gravity*, Nucl. Phys. B **340**, 281 (1990).
- [17] E. Witten, *Phases of $N = 2$ theories in two dimensions*, Nucl. Phys. B **403**, 159 (1993).
- [18] E. Getzler, *Batalin-Vilkovisky Algebras And Two-Dimensional Topological Field Theories*. Commun. Math. Phys. **159**, 265 (1994).
- [19] E. Getzler, *Two-Dimensional Topological Gravity And Equivariant Cohomology*. Commun. Math. Phys. **163**, 473 (1994).
- [20] M. Chas and D. Sullivan. *String Topology*. Preprint math.GT/9911159.
- [21] D. Sullivan. *Sigma models and string topology*. Graphs and patterns in mathematics and theoretical physics, 1–11, Proc. Sympos. Pure Math., 73, Amer. Math. Soc., Providence, RI, 2005. (Reviewer: David Chataur)
- [22] D. Sullivan. *Open and closed string field theory interpreted in classical algebraic topology*. Topology, geometry and quantum field theory, 344–357, London Math. Soc. Lecture Note Ser., 308, Cambridge Univ. Press, Cambridge, 2004
- [23] A. A. Voronov *Notes on universal algebra*. Graphs and patterns in mathematics and theoretical physics, 81–103, Proc. Sympos. Pure Math., 73, Amer. Math. Soc., Providence, RI, 2005.
- [24] R. M. Kaufmann. *On several varieties of cacti and their relations*. Algebraic & Geometric Topology **5** (2005), 237–300.
- [25] R. M. Kaufmann, M. Livernet and R. B. Penner, *Arc operads and arc algebras*, Geometry and Topology **7** (2003), 511–568.
- [26] R. C. Penner. “Decorated Teichmüller space of bordered surfaces”, *Communications in Analysis and Geometry* **12** (2004), 793–820, math.GT/0210326.

- [27] R. M. Kaufmann. *Operads, moduli of surfaces and quantum algebras*. Woods Hole mathematics, 133–224, Ser. Knots Everything, 34, World Sci. Publ., Hackensack, NJ, 2004.
- [28] I. Brunner, M. R. Douglas, A. E. Lawrence and C. Romelsberger, *D-branes on the quintic*. JHEP **0008**, 015 (2000)
- [29] K. Hori, A. Iqbal and C. Vafa, *D-branes and Mirror Symmetry*. Preprint hep-th/0005247.
- [30] M. R. Douglas, *D-branes, categories and $N = 1$ supersymmetry*, J. Math. Phys. **42**, 2818 (2001).
- [31] D. E. Diaconescu and M. R. Douglas, *D-branes on stringy Calabi-Yau manifolds*. Preprint hep-th/0006224.
- [32] J. Maldacena, G. Moore and N. Seiberg, *Geometric interpretation of D-branes in gauged WZW models*, Preprint hep-th/0105038.
- [33] S. Katz and E. Sharpe, *D-branes, open string vertex operators, and Ext groups*. Preprint hep-th/0208104.
- [34] D. Orlov, *Triangulated categories of singularities and D-branes in Landau-Ginzburg models*. Preprint math.AG/0302304.
- [35] I. Brunner, M. Herbst, W. Lerche and B. Scheuner, *Landau-Ginzburg realization of open string TFT*. Preprint hep-th/0305133.
- [36] C. I. Lazaroiu, *On the boundary coupling of topological Landau-Ginzburg models*. Preprint hep-th/0312286.
- [37] J. Fuchs and C. Schweigert. *Category theory for conformal boundary conditions*. Fields Inst. Comm. (2003) 25–71,
- [38] A. Kapustin and Y. Li, *D-branes in Landau-Ginzburg models and algebraic geometry*. JHEP **0312**, 005 (2003)
- [39] A. Kapustin and Y. Li, *Topological correlators in Landau-Ginzburg models with boundaries*. Preprint hep-th/0305136.
- [40] J. Fuchs, I. Runkel and C. Schweigert. *TFT construction of RCFT correlators III: Simple currents*. Nucl. Phys. (2004) 277–353,
- [41] S. K. Ashok, E. Dell’Aquila and D. E. Diaconescu, *Fractional branes in Landau-Ginzburg orbifolds*. Preprint hep-th/0401135.
- [42] M. Herbst and C. I. Lazaroiu, *Localization and traces in open-closed topological Landau-Ginzburg models*. Preprint hep-th/0404184.
- [43] M. Herbst, C. I. Lazaroiu and W. Lerche, *Superpotentials, A_∞ relations and WDVV equations for open topological strings*. Preprint hep-th/0402110.
- [44] A. Kapustin and L. Rozansky. *On the relation between open and closed topological strings*. Commun.Math.Phys. 252 (2004) 393-414
- [45] A. Kapustin and Y. Li. *Open String BRST Cohomology for Generalized Complex Branes*. hep-th/0501071
- [46] M. Gutperle and Y. Satoh, *D-branes in Gepner models and supersymmetry*. Nucl. Phys. B **543**, 73 (1999).
- [47] I. Brunner and V. Schomerus, *On superpotentials for D-branes in Gepner models*. JHEP **0010**, 016 (2000).
- [48] K. Hori and J. Walcher, *F-term equations near Gepner points*. Preprint hep-th/0404196.
- [49] K. Costello. *Topological conformal field theories and Calabi-Yau categories*. Preprint math.QA/0412149.

- [50] E. Harrelson. *On the homology of open-closed string field theory*. Preprint math.AT/0412249.
- [51] N. A. Baas, R. L. Cohen and A. Ramírez. *The topology of the category of open and closed strings*. Preprint math.AT/0411080.
- [52] H. Kajiura and J. Stasheff. *Homotopy algebras inspired by classical open-closed string field theory*. Preprint math.QA/0410291
- [53] H. Kajiura and J. Stasheff. *Open-closed homotopy algebra in mathematical physics*. Preprint hep-th/0510118
- [54] John H. Hubbard and Howard Masur, “Quadratic differentials and foliations”, *Acta Math.* **142** (1979), 221-274.
- [55] K. Strebel, Quadratic Differentials, *Ergebnisse der Math.* **3:5**, Springer-Verlag, Heidelberg (1984).
- [56] John L Harer, “Stability of the homology of the mapping class groups of orientable surfaces”, *Ann. of Math.* **121** (1985), 215-249.
- [57] John L Harer, “The virtual cohomological dimension of the mapping class group of an orientable surface”, *Invent. Math.* **84** (1986), 157-176.
- [58] R. C. Penner, “The decorated Teichmüller space of punctured surfaces”, *Communications in Mathematical Physics* **113** (1987), 299-339.
- [59] R. C. Penner. *The simplicial compactification of Riemann’s moduli space*. Proceedings of the 37th Taniguchi Symposium, World Scientific (1996), 237-252.
- [60] R. C. Penner, “Probing mapping class groups using arcs”, Problems on mapping class groups and related topics, ed. by B. Farb, to appear in Proc. Symp. Pure Math., AMS.
- [61] R. C. Penner, “The action of the mapping class group on isotopy classes of curves and arcs in surfaces”, thesis, Massachusetts Institute of Technology (1982), 180 pages.
- [62] A. Hatcher and W. Thurston, “A presentation for the mapping class group of a closed oriented surface”, *Topology* **19** (1980), 221-237.
- [63] E. Getzler and M. Kapranov. *Modular operads*. Compositio Math. 110 (1998), 65-126.
- [64] M. Markl, S. Shnider and J. Stasheff. *Operads in algebra, topology and physics*. Mathematical Surveys and Monographs, 96. American Mathematical Society, Providence, RI, 2002.
- [65] M. Markl. *Operads and PROPs*. Preprint math.AT/0601129
- [66] A. Fathi, F. Laudenbach, V. Poenaru, Travaux de Thurston sur les Surfaces, *Asterisque* **66-67**, Soc. Math. de France, Paris (1979).
- [67] R. C. Penner with J. L. Harer. *Combinatorics of Train Tracks*, Annals of Mathematical Studies 125, Princeton Univ. Press (1992); second printing (2001).
- [68] A. Papadopoulos and R. C. Penner, “The Weil-Petersson symplectic structure at Thurston’s boundary”, *Transactions of the American Math Society* **335** (1993), 891-904; “La forme symplectique de Weil-Petersson et le bord de Thurston de l’espace de Teichmüller”, *Comptes Rendus Acad. Sci. Paris* **312** Série I (1991), 871-874.
- [69] R. Kashaev. “Quantization of Teichmüller spaces and the quantum dilogarithm”, *Lett. Math. Phys.*, **43**, (1998), 105-115; q-alg/9705021.
- [70] A. Losev and Yu. Manin. *New moduli spaces of pointed curves and pencils of flat connections. Dedicated to William Fulton on the occasion of his 60th birthday*. Michigan Math. J. 48 (2000).

- [71] R. C. Penner. *The action of the mapping class group on curves in surfaces*. L'Enseignement Math. **30**, 39-55 (1984).
- [72] N. P. Warner. *Supersymmetry in boundary integrable models*. Nucl. Phys. **B450** (1995) 663–694.
- [73] R. M. Kaufmann. *Moduli space actions on the Hochschild Co-Chains of a Frobenius algebra*. Manuscript (2005).
- [74] C. Vafa, *Topological Landau-Ginzburg Models*. Mod. Phys. Lett. A **6**, 337 (1991).
- [75] Yu. I. Manin, *Three constructions of Frobenius manifolds: a comparative study*. in: Sir Michael Atiyah, a great mathematician of the twentieth century, Asian J. of Math. **3** (1999) 179
- [76] K. A. Intriligator and C. Vafa, *Landau-Ginzburg Orbifolds*. Nucl. Phys. B **339**, 95 (1990).
- [77] R. Kaufmann. *Singularities with Symmetries, Orbifold Frobenius algebras and Mirror Symmetry*. Contemp. Math., to appear. Preprint math.AG/0312417
E-mail address: kaufmann@math.uconn.edu, rpenner@usc.edu