

EXPLICIT HORIZONTAL OPEN BOOKS ON SOME SEIFERT FIBERED 3-MANIFOLDS

BURAK OZBAGCI

ABSTRACT. We describe explicit horizontal open books on some Seifert fibered 3-manifolds. We show that the contact structures compatible with these horizontal open books are Stein fillable and horizontal as well. Moreover we draw surgery diagrams for some of these contact structures.

1. INTRODUCTION

An open book on a Seifert fibered 3-manifold is called *horizontal* if its binding is a collection of some fibers and its pages are positively transverse to the Seifert fibration. Here we require that the orientation induced on the binding by the pages coincides with the orientation of the fibers induced by the fibration. In this article, we construct explicit horizontal open books on some Seifert fibered 3-manifolds. We show that the monodromies of these horizontal open books are given by products of (multiple) right-handed Dehn twists along boundary parallel curves. Consequently, by a theorem of Giroux [Gi], the contact structures compatible with our horizontal open books are Stein fillable. We also show that these contact structures are horizontal, i.e., the contact planes are positively transverse to the fibers of the Seifert fibrations. Finally we draw surgery diagrams for those contact structures which are compatible with planar open books.

It is well-known that any Seifert fibered 3-manifold can be obtained by a plumbing of circle bundles according to a “standard” diagram. The standard diagram is a star shaped graph, with k linear branches, whose central vertex is a circle bundle over an arbitrary closed surface with arbitrary Euler number n and all the other vertices are circle bundles over S^2 with Euler numbers less than or equal to -2 . In this language a vertex always represents a circle bundle and an edge between two vertices represents plumbing of the circle bundles represented by the vertices. We will call a standard diagram with $n + k \leq 0$ as *non-positive* standard plumbing diagram.

Date: July 10, 2018.

2000 *Mathematics Subject Classification.* 57R17.

The author was partially supported by the Turkish Academy of Sciences and by the NSF Focused Research Grant FRG-024466.

In this article we consider Seifert fibered 3–manifolds given by plumbing of circle bundles according to a star shaped graph, with a central vertex, a circle bundle over an arbitrary closed surface with non-positive Euler number, and k other vertices which are circle bundles over S^2 with positive Euler numbers, all connected to the central vertex. Note that these are a priori non-standard plumbing diagrams. We construct open books on these Seifert fibered 3–manifolds which are horizontal with respect to their Seifert fibrations. However, we can convert these diagrams into non-positive standard plumbing diagrams so that the Euler numbers of all the vertices except the central vertex are equal to -2 . In [EO], explicit open books were constructed on Seifert fibered 3–manifolds which can be described by non-positive standard plumbing diagrams. Moreover it was shown that these open books are horizontal with respect to the circle bundles involved in the plumbing descriptions of the Seifert fibered 3–manifolds at hand. It turns out that the horizontal open book we construct in this article using a non-standard plumbing description of a Seifert fibered 3-manifold is isomorphic to the horizontal open book constructed in [EO] starting with the non-positive standard plumbing description of the same manifold. The difference is that here horizontal means transverse to the Seifert fibers and in [EO] horizontal means transverse to the circle bundles involved in a plumbing description of a Seifert fibered 3–manifold. It is not clear to the author whether or not these two different definitions of being horizontal are equivalent in general.

In particular suppose that the circle bundle at the central vertex in the plumbings are also over S^2 . Then the open books we construct are planar, which means that a page has genus zero. The significance of finding contact structures compatible with planar open books stems from the recent work of Abbas, Cieliebak and Hofer [ACH] who proved the Weinstein conjecture for those contact structures. In [Sc], Schönenberger also constructs planar open books compatible with Stein fillable contact structures which are given by Legendrian surgeries on any Legendrian realization of a non-positive standard diagram of a Seifert fibered 3–manifold. We can pin down the Stein fillable horizontal contact structures compatible with the horizontal open books we construct, by comparing our construction with Schönenberger’s method.

Acknowledgement: We are grateful to John Etnyre for helpful conversations and András Stipsicz for generously sharing his expertise and commenting on the first draft of this paper.

2. OPEN BOOK DECOMPOSITIONS AND CONTACT STRUCTURES

We will assume throughout this paper that a contact structure $\xi = \ker \alpha$ is coorientable (i.e., α is a global 1–form) and positive (i.e., $\alpha \wedge d\alpha > 0$). In the following we describe the compatibility of an open book decomposition with a given contact structure on a 3–manifold.

Suppose that for an oriented link L in a closed and oriented 3-manifold Y the complement $Y \setminus L$ fibers over the circle as $\pi: Y \setminus L \rightarrow S^1$ such that $\pi^{-1}(\theta) = \Sigma_\theta$ is the interior of a compact surface bounding L , for all $\theta \in S^1$. Then (L, π) is called an *open book decomposition* (or just an *open book*) of Y . For each $\theta \in S^1$, the surface Σ_θ is called a *page*, while L the *binding* of the open book. The monodromy of the fibration π is defined as the diffeomorphism of a fixed page which is given by the first return map of a flow that is transverse to the pages and meridional near the binding. The isotopy class of this diffeomorphism is independent of the chosen flow and we will refer to that as the *monodromy* of the open book decomposition.

Example: Consider the positive Hopf link H (see Figure 1) in S^3 . Note that S^3 has a Heegaard splitting of genus one, and each piece in the splitting can be taken as a regular solid torus neighborhood N_i (cf. Figure 2) of the component H_i of H , for $i = 1, 2$.

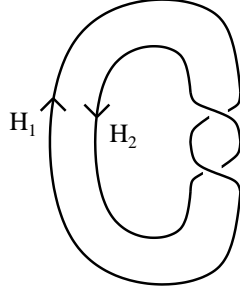

FIGURE 1. Positive Hopf link H in S^3

Take the core circle H_1 of N_1 and consider the annulus A_1 bounded by H_1 and a $(1, -1)$ -curve λ on ∂N_1 . Observe that the λ becomes a $(-1, 1)$ -curve on ∂N_2 . There is another annulus A_2 bounded by H_2 and $-\lambda$ on ∂N_2 . Then the annulus $A = A_1 \cup A_2$ is bounded by the Hopf link H in $S^3 = N_1 \cup N_2$. Now by foliating each N_i by (a circle worth of) annuli A_i and gluing the corresponding leafs (cf. Figure 2) we get a fibration $S^3 \setminus H \rightarrow S^1$ of the complement of H in S^3 with annuli pages A each of which is bounded by H . Note that the annulus A is a copy of the obvious Seifert surface bounded by $H = H_1 \cup H_2$ in Figure 1.

To see the monodromy of the resulting open book take a vector field in N_i so that it has constant slope 1 on ∂N_i , and its slope smoothly decreases to zero as we move towards H_i on any horizontal ray so that it becomes meridional near the core circle H_i . Note that this defines a vector field on $S^3 = N_1 \cup N_2$ which is transverse to the pages of the open book and becomes meridional near the binding H . The first return map of the flow induced by this vector field is a right-handed Dehn twist along the center circle of a fixed page A in the open book.

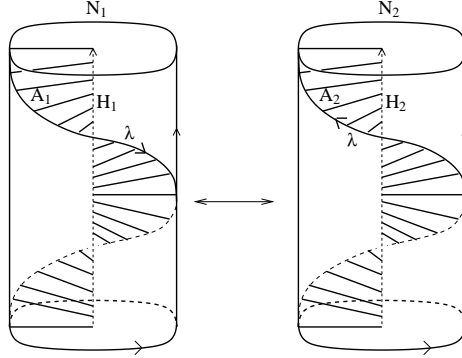

FIGURE 2. By gluing the two solid tori we can visualize an open book of S^3 , with binding H , whose page is obtained by gluing A_1 with A_2 along λ .

Every closed and oriented 3–manifold admits an open book decomposition (cf. [Al]) as well as a contact structure (cf. [Ma]). An open book decomposition and a contact structure is related by the following definition.

Definition 1. *An open book decomposition (L, π) of a 3–manifold Y and a contact structure ξ on Y are called compatible if ξ can be represented by a contact form α such that $\alpha(L) > 0$ and $d\alpha > 0$ on every page.*

Example: Consider the unit sphere $S^3 = \{(z_1, z_2) : |z_1|^2 + |z_2|^2 = 1\} \subset \mathbb{C}^2$. In these coordinates the positive Hopf link is given by

$$H = \{(z_1, z_2) : z_1 z_2 = 0\} = H_1 \cup H_2$$

where $H_1 = \{(z_1, z_2) : z_2 = 0\}$ and $H_2 = \{(z_1, z_2) : z_1 = 0\}$. Let $\pi : S^3 \setminus H \rightarrow S^1$ be defined as

$$\pi(z_1, z_2) = \frac{z_1 z_2}{|z_1 z_2|} \in S^1 \subset \mathbb{C}.$$

In polar coordinates the map π can be expressed as : $\pi(r_1 e^{i\theta_1}, r_2 e^{i\theta_2}) = e^{i(\theta_1 + \theta_2)}$. Then for a fixed $\theta_0 \in S^1$ we have

$$\pi^{-1}(\theta_0) = \{(\theta_1, r_1, \theta_2, r_2) : \theta_1 + \theta_2 = \theta_0, r_1^2 + r_2^2 = 1\}.$$

Note that the equation $r_1^2 + r_2^2 = 1$ gives an arc between a point in H_1 with coordinate θ_1 and the point in H_2 with coordinate $\theta_2 = \theta_0 - \theta_1$. The union of these arcs will sweep out the annulus $\pi^{-1}(\theta_0)$ which bounds H . On the other hand, the standard contact structure ξ in S^3 can be given as the kernel of the 1–form $\alpha = r_1^2 d\theta_1 + r_2^2 d\theta_2$, restricted to $S^3 \subset \mathbb{C}^2$. To show that α is compatible with the open book above we first observe that $\alpha(H_i) = d\theta_i(\partial_{\theta_i}) = 1$. Next we parameterize $\pi^{-1}(\theta_0)$ by

$$f(r, \theta) = (r, \theta, \sqrt{1 - r^2}, \theta_0 - \theta_1).$$

Thus $f^*(\alpha) = (2r^2 - 1)d\theta$ and $f^*(d\alpha) = df^*(\alpha) = 4rdrd\theta$. We conclude that $d\alpha$ is an area form on $\pi^{-1}(\theta_0)$, for all $\theta_0 \in S^1$.

We have the following fundamental results at our disposal to study the contact topology of 3-manifolds.

Theorem 2 (Thurston-Winkelnkemper [TW]). *Every open book admits a compatible contact structure.*

Conversely,

Theorem 3 (Giroux [Gi]). *Every contact 3-manifold admits a compatible open book. Moreover two contact structures compatible with the same open book are isotopic.*

We refer the reader to [Et] and [OS] for more on the correspondence between open books and contact structures.

3. EXPLICIT CONSTRUCTION OF HORIZONTAL OPEN BOOKS ON SOME SEIFERT FIBERED 3-MANIFOLDS

Consider the S^1 -bundle $Y_{g,n}$ over a closed and oriented genus g surface Σ with Euler number $e(Y_{n,g}) = n$, as the boundary of the corresponding D^2 -bundle over Σ with one 0-handle, $2g$ 1-handles and one 2-handle (with framing n) as in Figure 3. The 3-manifold Y obtained from $Y_{g,n}$ by performing $-1/r_1, \dots, -1/r_k$ surgeries on k distinct fibers (cf. Figure 3) is called a *Seifert fibered 3-manifold* with Seifert invariants $(g, n; r_1, \dots, r_k)$ where $r_i \in \mathbb{Q}$. Notice that according to this convention the surgery coefficients are negative reciprocals of the given data.

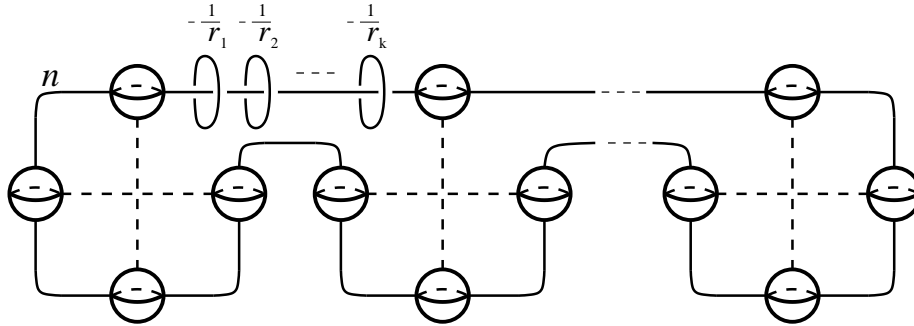

FIGURE 3. Seifert fibered 3-manifold with Seifert invariants $(g, n; r_1, \dots, r_k)$. (There are $2g$ 1-handles in the figure.)

An open book on a Seifert fibered 3-manifold is called *horizontal* if its binding is a collection of some fibers and the interiors of its pages are positively transverse to the Seifert fibration. Here we require that the orientation induced on the binding by the pages coincides

with the orientation of the fibers induced by the fibration. In this article we construct horizontal open books on Seifert fibered 3-manifolds with invariants $(g, n; r_1, \dots, r_k)$, where $g \geq 0$ is arbitrary and

$$n \leq 0 < -\frac{1}{r_i} \in \mathbb{N}, \text{ for } 1 \leq i \leq k.$$

Let Σ denote a closed oriented surface and let M denote the trivial circle bundle over Σ , i.e., $M = S^1 \times \Sigma$. Perform a $+1$ -surgery along circle fiber K of M . The resulting 3-manifold M' is a circle bundle over Σ whose Euler number is equal to -1 . In [EO] we described an explicit horizontal open book on M' : A fiber becomes the binding, every page is a once punctured Σ , and the monodromy is right-handed Dehn twist along a curve parallel to the binding. Then as discussed in [EO], to obtain a horizontal open book on a circle bundle with Euler number $n < 0$ we need to perform $+1$ -surgeries along $|n|$ distinct fibers.

We claim that we can generalize the arguments used in [EO], for a $+1$ -surgery, to a p -surgery (for any $0 < p \in \mathbb{N}$) to obtain horizontal open books on some Seifert fibered 3-manifolds. To perform a p -surgery on a fiber K of M we first remove a solid torus neighborhood $N = K \times D^2$ of K from M . Note that by removing N from M we puncture once each Σ in $M = S^1 \times \Sigma$ to get $S^1 \times \tilde{\Sigma}$, where $\tilde{\Sigma} = \Sigma \setminus D^2$. Now we will glue a solid torus back to $S^1 \times \tilde{\Sigma}$ along its boundary torus $S^1 \times \partial\tilde{\Sigma}$ in order to perform our surgery.

In the discussion below we will make no distinction between curves on a surface and the homology classes they represent, to simplify the notation. Consider the solid torus $S^1 \times D^2$ shown on the left-hand side in Figure 4. Let μ and λ be the meridian and the longitude pair of $S^1 \times \partial D^2$. Let m and l denote the meridian and the longitude pair in the boundary of $S^1 \times \tilde{\Sigma}$. Note that the base surface is oriented (as depicted in Figure 4) and the orientation induced on $\partial\tilde{\Sigma}$ is the opposite of the orientation of m . We glue the solid torus $S^1 \times D^2$ to $S^1 \times \tilde{\Sigma}$ by an *orientation preserving* diffeomorphism $S^1 \times \partial D^2 \rightarrow S^1 \times \partial\tilde{\Sigma}$ which sends μ to $pm + l$ and λ to $(p^2 - 1)m + pl$. (This map is in fact orientation reversing if we use the orientation on the torus $S^1 \times \partial\tilde{\Sigma}$ which is induced from $S^1 \times \tilde{\Sigma}$.) The resulting 3-manifold M' will be oriented extending the orientation on $S^1 \times \tilde{\Sigma}$ induced from M .

We also depict, in Figure 4, a leaf (an annulus) of a foliation on the solid torus $S^1 \times D^2$ that we will glue to perform p -surgery. Note that under the surgery map $p\lambda - (p^2 - 1)\mu$ is mapped onto l which parametrizes the S^1 factor in $S^1 \times \tilde{\Sigma}$. We can view $S^1 \times (D^2 - \{0\})$ as a disjoint union of concentric tori and foliate each torus by (a circle worth of) curves isotopic to $p\lambda - (p^2 - 1)\mu$. This gives a foliation of $S^1 \times D^2$ into circles where the center circle $S^1 \times \{0\}$ is covered p -times by all the other circles in the foliation. Note that this circle foliation defines the Seifert fibration. Observe that the Seifert fibration on $S^1 \times D^2$ is transverse to the annuli foliation simply because the slope of the circles is less than the slope of the annular pages in $S^1 \times D^2$.

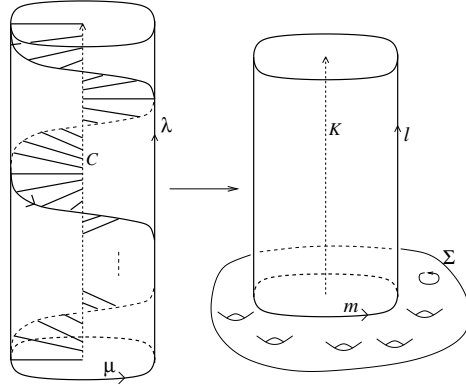

FIGURE 4. The surgery torus is obtained by identifying the top and the bottom of the cylinder shown on the left-hand side. The annulus depicted inside the torus is wrapped p -times around the core circle in a right-handed manner. On the right hand side we depict the complement $S^1 \times \tilde{\Sigma}$ obtained by removing a neighborhood of a circle fiber from $S^1 \times \Sigma$.

The boundary of a leaf consists of the core circle C of $S^1 \times D^2$ and a $(p, -1)$ -curve on $S^1 \times \partial D^2$, i.e., a curve isotopic to $p\mu - \lambda$. Each leaf is oriented so that the induced orientation on the boundary of a leaf is given as indicated in Figure 4. The gluing diffeomorphism maps $p\mu - \lambda$ onto m so that by performing the p -surgery we also glue each annulus in the foliation to a $\tilde{\Sigma}$ in $S^1 \times \tilde{\Sigma}$ identifying the outer boundary component (i.e., the $(p\mu - \lambda)$ -curve) of the annulus with $\partial\tilde{\Sigma}$. Hence this construction yields a horizontal open book on M' whose binding is C (the core circle of the surgery torus) and pages are obtained by gluing an annulus to each $\tilde{\Sigma}$ along $\partial\tilde{\Sigma}$. Notice that the pages will be oriented extending the orientation on $\tilde{\Sigma}$ induced from Σ . Finally we want to point out that the core circle C becomes an oriented fiber of the Seifert fibration of M' over Σ . In fact C becomes a singular fiber if $p > 1$.

Next we will describe the monodromy of this open book. In order to measure the monodromy of an open book we should choose a flow which is transverse to the pages and meridional near the binding. We will take a *vertical* vector field pointing along the fiber direction in $S^1 \times \tilde{\Sigma}$ and extend it inside the surgery torus as follows: The vertical vector field is given by ∂_t on $S^1 \times \partial\tilde{\Sigma}$ which is identified with $p\partial_\lambda - (p^2 - 1)\partial_\mu$ on the boundary of the surgery torus. Extend this vector field with slope $-p/(p^2 - 1)$ inside the surgery torus (along every ray towards the core circle) by rotating clockwise so that it becomes horizontal near the core circle as illustrated in Figure 5. First observe that this vector field is positively transverse to the pages of the open book by construction since $-p/(p^2 - 1) < -1/p$. In other words one can see that this vector field always points towards the positive side of

the annulus in Figure 4 by comparing the slope of the annulus (a page) with the slope of the vector field. Next note that the first return map of the flow will fix the points near the binding on any leaf since the vector field is horizontal near the binding. The first return map will fix the points on $\tilde{\Sigma}$ as well, since the flow is vertical (i.e., in the direction tangent to the S^1 factor) on $S^1 \times \tilde{\Sigma}$. Now take a horizontal arc (on a leaf) connecting the core circle to the other boundary of that leaf. Then one can see that the flow will move the points of this arc further to the right if we move towards the boundary. The first return map is given by a right-handed Dehn twist along the core circle of the leaf when we go around λ once. But since a circle fiber l covers the core circle λ (p singular fiber for $p > 1$) p -times, the first return map of the open book is given by the p -th power of a right-handed Dehn twist along the core circle of the leaf in Figure 4, which is indeed a curve parallel to the binding of the open book.

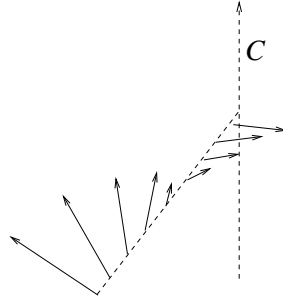

FIGURE 5. The vector field depicted along a ray towards the core circle C inside the surgery torus extending the vertical one on $S^1 \times \tilde{\Sigma}$. The vector field becomes horizontal near the core (binding) along any ray.

In summary we constructed a horizontal open book on a Seifert fibered 3-manifold with invariants $(g, 0; r)$ for $0 < p = -\frac{1}{r} \in \mathbb{N}$ by performing a p -surgery on a fiber of a trivial circle bundle over a genus g -surface Σ . Note that the binding is a singular fiber of the Seifert fibration if $-\frac{1}{r} = p > 1$. Since surgery modifies the open book only in a neighborhood of the surgery curve in the above construction, we can construct a horizontal open book on the Seifert fibered 3-manifold with invariants $(g, 0; r_1, \dots, r_k)$ where $0 < -\frac{1}{r_i} \in \mathbb{N}$, for $1 \leq i \leq k$. Moreover if we start with the trivial circle bundle, perform $+1$ -surgeries on $|n|$ distinct fibers (cf. [EO]) for $n < 0$, and then further perform $-1/r_1, \dots, -1/r_k$ surgeries on k disjoint fibers, respectively, where $0 < -\frac{1}{r_i} \in \mathbb{N}$, for $1 \leq i \leq k$, we will get a horizontal open book on the Seifert fibered 3-manifold with invariants $(g, n; r_1, \dots, r_k)$. The binding of the resulting open book will be the union of $k + |n|$ circle fibers and a page is a genus g surface with $k + |n|$ boundary components. The monodromy will be a product of (multiple) right-handed Dehn twists along boundary parallel curves. More precisely,

there are $|n|$ boundary components each of which has one right-handed Dehn twist and for the other k components of the boundary the exponent of the right-handed Dehn twist is given by $p_i = -1/r_i$, for $1 \leq i \leq k$. Since the monodromy is a product of right-handed Dehn twists only, the contact structure compatible with this open book is Stein fillable by a theorem of Giroux (cf. [Gi]). Thus we showed

Proposition 4. *There exists an explicit horizontal open book on the Seifert fibered 3-manifold with invariants $(g, n; r_1, \dots, r_k)$, where $n \leq 0 < -\frac{1}{r_i} \in \mathbb{N}$, for $1 \leq i \leq k$. The contact structure compatible with this open book is Stein fillable.*

Next we consider the contact structure compatible with our open book.

Proposition 5. *The contact structure compatible with the open book we constructed on the Seifert fibered 3-manifold with invariants $(g, n; r_1, \dots, r_k)$, such that $n \leq 0 < -\frac{1}{r_i} \in \mathbb{N}$, for $1 \leq i \leq k$, is horizontal, i.e., the contact planes are positively transverse to the fibers of the Seifert fibration.*

Proof. Consider the contact structure compatible with the constructed horizontal open book. By an isotopy of this contact structure we may assume that the contact planes are arbitrarily close to the tangents of the pages away from the binding (cf. Lemma 3.5 in [Et]). Since the pages of our open book are already positively transverse to the fibers we can conclude that the contact planes are positively transverse to the fibers away from the binding. Note that the contact structure is still compatible with the given open book after this isotopy.

Recall that we explicitly constructed the pages of the open book near a component C of the binding. The fibers of the circle fibration can be viewed as straight vertical lines in the solid cylinder on the left-hand side in Figure 4 before we identify the top and the bottom. On the other hand, by the compatibility of the open book and the contact structure, there are coordinates $(z, (r, \theta))$ near every component C , where C is $\{r = 0\}$ and a page is given by setting θ equal to a constant such that the contact structure is given by the kernel of the form $dz + r^2 d\theta$. In these coordinates the neighborhood of C in Figure 4 is seen as in Figure 6, where the annulus is straightened out and the circle fibers are wrapped around the cylinder in a right-handed manner. More precisely, the tangent vector to an (oriented) fiber is given by $\partial_\theta + p\partial_z$. Since

$$(dz + r^2 d\theta)(\partial_\theta + p\partial_z) = r^2 + p > 0,$$

the contact planes are positively transverse to the circle fibers in a neighborhood of C . This finishes the proof of the proposition. \square

Remark 6. *The proof above shows that in fact, the contact structure compatible with a horizontal open book on any Seifert fibered 3-manifold is horizontal. This is because, in a local model near the binding, a Seifert fiber has to be of the form $a\partial_\theta + b\partial_z$, for some positive integers a and b , and indeed we have $(dz + r^2 d\theta)(a\partial_\theta + b\partial_z) = ar^2 + b > 0$.*

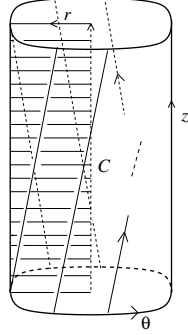

FIGURE 6. A page is straightened out near a binding component C in these coordinates. A Seifert fiber is given by a $(1, p)$ -curve in a neighborhood of C .

Note that the horizontal open book we constructed on the Seifert fibered 3-manifold with invariants $(0, n; r_1, \dots, r_k)$, where $n \leq 0 < -\frac{1}{r_i} \in \mathbb{N}$, for $1 \leq i \leq k$, is planar, i.e., a page has genus zero. Recently it was shown in [ACH] that the Weinstein conjecture holds for a contact structure compatible with a planar open book.

The same construction of an open book will work when we perform p -surgeries along fibers of a circle bundle for $p < 0$, but in that case the orientation on the binding induced by the pages will be the opposite of the fiber orientation. Thus the open book we construct using p -surgeries will not be horizontal when $p < 0$. Moreover we will get left-handed Dehn twists along boundary components instead of right-handed Dehn twists in that case. Finally, when we perform 0-surgery along a fiber of a trivial circle bundle over Σ , we still get an open book where the binding is a fiber, page is once punctured Σ and monodromy is the identity map. Note, however, that a circle bundle does not extend to a Seifert fibration when we do 0-surgery on a regular fiber. Combining all the discussion above we get the following:

Corollary 7. *Let Y be a 3-manifold with an open book whose page is a genus g surface Σ with r boundary components and let δ_i denote a curve parallel to the i -th boundary component of Σ . If the monodromy of this open book can be factorized as $\phi = \prod_{i=1}^r t_{\delta_i}^{m_i}$ for some nonzero integers m_1, m_2, \dots, m_r then Y is a Seifert fibered 3-manifold. This open book can be realized as a horizontal open book with respect to the Seifert fibration if and only if $m_i > 0$ for all $i = 1, 2, \dots, r$.*

Proof. The first statement and the sufficiency of the second statement should be clear from the arguments above. To prove the necessity of the second statement let us assume that $m_j < 0$ for some j . Then one can see that there is a properly embedded arc on Σ with

an initial point on the j -th component of $\partial\Sigma$ which is not right-veering, unless $g = 0$ and $r = 1, 2$. Hence by [HKM], this open book can not be compatible with a tight contact structure. But it is known (cf. [LM]) that any horizontal contact structure on a Seifert fibered 3-manifold is fillable, hence tight. This proves, by Remark 6, that the open book can not be made horizontal under the given assumption. The cases we left out above can be easily treated separately. \square

It was shown in [DG] that any contact 3-manifold can be obtained by contact (± 1) -surgeries along a Legendrian link in the standard contact S^3 . The next result can be viewed as a variation of their theorem. Although the result is not new, we believe that it is a “natural” way—from the mapping class groups point of view—of thinking about the contact structures along with their compatible open books. The reader may turn to [Ko], for some facts we will use below about the mapping class groups.

Corollary 8. *Any contact 3-manifold can be obtained by contact (± 1) -surgeries from a contact structure on some Seifert fibered 3-manifold.*

Proof. Let (Y, ξ) be a contact 3-manifold. By Giroux’s Theorem 3, there is an open book \mathfrak{ob} of Y compatible with ξ whose page is a compact oriented surface Σ with r boundary components, and whose monodromy is $\phi : \Sigma \rightarrow \Sigma$. Let δ_i denote a curve parallel to the i -th boundary component of Σ . Then there is a factorization of ϕ into Dehn twists along some non-separating curves on Σ and curves parallel to the boundary components of Σ . We can assume that $\phi = \phi' \circ \psi$, where ψ denotes the product of all the boundary parallel Dehn twists in the factorization of ψ , since these curves are clearly disjoint from the rest of the curves in the factorization. Moreover we can also assume that $\psi = \prod_{i=1}^r t_{\delta_i}^{m_i}$ for some nonzero integers m_1, m_2, \dots, m_r by inserting some canceling Dehn twists into the factorization of ϕ and using the lantern relation in the mapping class groups. Here, if necessary, we can increase the genus of the page by some positive stabilizations. By Corollary 7, there is a Seifert fibered 3-manifold Y_ψ with an open book \mathfrak{ob}_ψ whose page is Σ and whose monodromy is ψ . Now consider the contact structure ξ_ψ on Y_ψ compatible with \mathfrak{ob}_ψ . Embed all the curves which appear in the factorization of ϕ' on different pages of \mathfrak{ob}_ψ . Since these curves are homologically nontrivial on Σ , we can Legendrian realize these curves on the convex pages of \mathfrak{ob}_ψ with respect to ξ_ψ . Now applying contact (-1) -surgeries on curves which correspond to right-handed Dehn twists and contact $(+1)$ -surgeries which correspond to left-handed Dehn twists yields Y with the open book \mathfrak{ob} and its compatible contact structure ξ . So we showed that (Y, ξ) can be obtained by contact (± 1) -surgeries along Legendrian curves in the contact Seifert fibered 3-manifold (Y_ψ, ξ_ψ) . \square

4. SURGERY DIAGRAMS OF SOME HORIZONTAL CONTACT STRUCTURES

Consider a Seifert fibered 3–manifold with invariants

$$(g, n; -\frac{1}{p_1}, \dots, -\frac{1}{p_k})$$

such that $n \leq 0 < p_i$, for $i = 1, \dots, k$. We can describe this 3–manifold as a plumbing of circle bundles according to a star shaped graph with a central vertex connected to k other vertices. The central vertex represents a bundle over a closed genus g surface whose Euler number is n and the other k vertices represent bundles over S^2 with Euler numbers p_i , for $i = 1, \dots, k$.

We now show how to put this plumbing diagram into a standard form: First observe that we can assume $p_i > 1$ for all i , since otherwise we can blow down all the $(+1)$ -vertices which will only decrease n . Next blow up all the intersections of the central vertex with the other k vertices. The resulting plumbing graph will have a central vertex with Euler number $n - k$ and k linear branches coming out of the central vertex whose vertices have Euler numbers $(n - k, -1, p_i - 1)$, including the central vertex, for $i = 1, \dots, k$. Then blow up the intersection of -1 and $p_i - 1$ at every branch to end up with the vertices having Euler numbers $(n - k, -2, -1, p_i - 2)$ on the i -th branch. Continue this process $p_i - 1$ times on the i -th branch, so that Euler numbers on each branch becomes $(n - k, -2, -2, \dots, -2, -1, 1)$. Finally blow down the last $+1$ to get the sequence $(n - k, -2, -2, \dots, -2, -2)$, on each branch, where the number of -2 's is equal to $p_i - 1$ on the i -th branch.

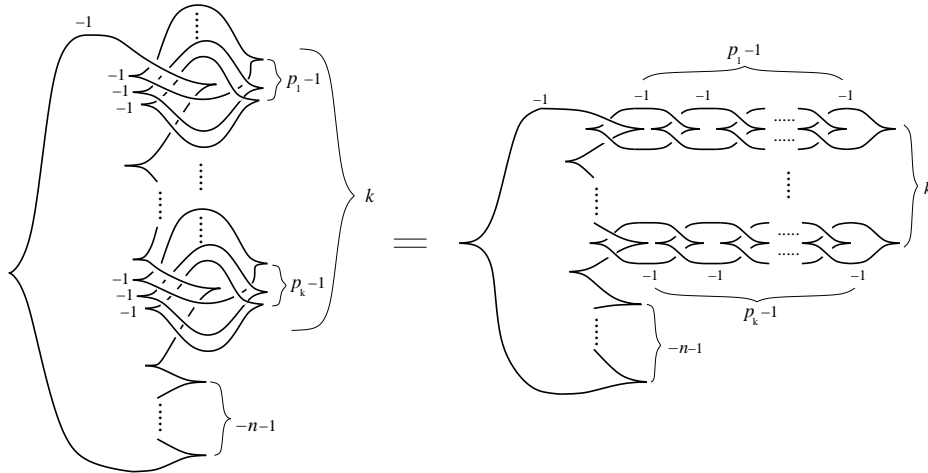

FIGURE 7. Horizontal contact structures on some Seifert fibered 3–manifolds

Note that this is a non-positive standard plumbing diagram for the given Seifert fibered 3–manifold. Now we observe that the horizontal open book obtained by applying the algorithm in [EO] to this non-positive plumbing is isomorphic to the horizontal open book we constructed in Section 3. Suppose that $g = 0$. Then by comparing this construction with Schönenberger’s method (cf. [Sc]) we conclude that the horizontal contact structure compatible with the horizontal open book on the Seifert fibered 3–manifold with invariants $(0, n; -1/p_1, \dots, -1/p_k)$ where $n < 0 < p_i$ can be described by the surgery diagram on the left-hand side in Figure 7. Moreover one can show that the contact structure on the left-hand side is isotopic to the contact structure depicted on the right-hand side.

REFERENCES

- [ACH] C. Abbas, K. Cieliebak, H. Hofer, *The Weinstein conjecture for planar contact structures in dimension three*; arXiv:math.SG/0409355.
- [Al] J. Alexander, *A lemma on systems of knotted curves*, Proc. Nat. Acad. Sci. USA **9** (1923), 93–95.
- [DG] F. Ding and H. Geiges, *A Legendrian surgery presentation of contact 3-manifolds*, Math. Proc. Cambridge Philos. Soc. **136** (2004), 583–598.
- [EO] T. Etgü and B. Ozbagci, *Explicit horizontal open books on some plumbings*, to appear in the Inter. Jour. of Math.; arXiv:math.GT/0509611
- [Et] J. Etnyre, *Lectures on open book decompositions and contact structures*, Lecture notes from the Clay Mathematics Institute Summer School on Floer Homology, Gauge Theory, and Low Dimensional Topology at the Alfréd Rényi Institute; arXiv:math.SG/0409402.
- [Gi] E. Giroux, *Géométrie de contact: de la dimension trois vers les dimensions supérieures*, Proceedings of the International Congress of Mathematicians (Beijing 2002), Vol. II, 405–414.
- [HKM] K. Honda, W. Kazez, G. Matic, *Right-veering diffeomorphisms of compact surfaces with boundary I*, arXiv:math.GT/0510639
- [Ko] M. Korkmaz, *Low-dimensional homology groups of mapping class groups: a survey*, Turkish J. Math. **26** (2002), 101–114.
- [LM] P. Lisca and G. Matic, *Transverse contact structures on Seifert 3–manifolds* Algebr. Geom. Topol. **4** (2004) 1125–1144.
- [Ma] J. Martinet, *Formes de contact sur les variétés de dimension 3*, in: Proc. Liverpool Singularity Sympos. II, Lecture Notes in Math. **209**, Springer, Berlin (1971), 142–163.
- [OS] B. Ozbagci and A. Stipsicz, *Surgery on contact 3–manifolds and Stein surfaces*, Bolyai Soc. Math. Stud., Vol. **13**, Springer, 2004.
- [Sc] S. Schönenberger, *Planar open books and symplectic fillings*, Ph.D. Dissertation, University of Pennsylvania, 2005.
- [TW] W. Thurston and H. Winkelnkemper, *On the existence of contact forms*, Proc. Amer. Math. Soc. **52** (1975), 345–347.

DEPARTMENT OF MATHEMATICS, KOÇ UNIVERSITY, ISTANBUL, TURKEY
E-mail address: bozbagci@ku.edu.tr

CURRENT: SCHOOL OF MATHEMATICS, GEORGIA INSTITUTE OF TECHNOLOGY, ATLANTA, GEORGIA, USA
E-mail address: bozbagci@math.gatech.edu