

Hyperfinite knots

via the CJKLS invariant in the thermodynamic limit

Pedro Lopes
 Departamento de Matemática
 Instituto Superior Técnico
 Av. Rovisco Pais
 1049-001 Lisboa
 Portugal
 pelopes@math.ist.utl.pt

July 8, 2006

Abstract

We set forth a definition of hyperfinite knots. Loosely speaking, these are limits of certain sequences of knots with increasing crossing number. These limits exist in appropriate closures of quotient spaces of knots. We give examples of hyperfinite knots. These examples stem from an application of the Thermodynamic Limit to the CJKLS invariant of knots.

1 Introduction

In this article we set a forth a definition of hyperfinite knots. This definition was originally motivated by trying to regard the CJKLS invariant ([6, 12]) as a partition function of Statistical Mechanics ([4]), and extracting its Thermodynamic Limit ([2]).

1.1 Hyperfinite knots

Assume there is an invariant of knots, f , which takes values on a closed metric space, \mathbf{M} , and consider a quotient space of knots, \mathcal{K}_f . Two knots belong to the same equivalence class of this quotient if they have the same value of the invariant, f . In particular, knots which are deformable into each other lie in the same equivalence class. For any knot K , let K^\sim denote the equivalence class, in \mathcal{K}_f , which contains K . The map f induces an embedding of this quotient space into \mathbf{M} . This allows us to regard \mathcal{K}_f as a subspace of \mathbf{M} . Let $\overline{\mathcal{K}_f}$ denote the topological closure of \mathcal{K}_f with respect to the metric in \mathbf{M} .

Consider a sequence of knots, (K_n) , which is a sequence of representatives of distinct equivalence classes of the indicated quotient space, with increasing crossing number. Assume further that the sequence, $(f(K_n))$ converges in the closed metric space. There is then an element of $\overline{\mathcal{K}_f}$, call it K_∞ , which is the limit of the sequence (K_n^\sim) , in the metric of \mathbf{M} . We state this as

$$K_\infty = \lim_{n \rightarrow \infty} K_n^\sim$$

We call K_∞ , as obtained above, a *hyperfinite knot*.

Furthermore, note that the limit of the invariant, $\lim_{n \rightarrow \infty} f(K_n)$, is an invariant of the *hyperfinite knot* $K_\infty = \lim_{n \rightarrow \infty} K_n^\sim$, keeping the notation above.

In this article we provide instances where the assumptions above materialize into concrete examples. This is done by way of a new invariant of knots which is motivated by applying the so-called Thermodynamic Limit of Exactly Solved Models ([2]) to the CJKLS invariant ([6]).

1.2 The CJKLS invariant and the thermodynamic limit

For each specification of labelling quandle X , finite abelian group A of order N , and 2-cocycle $\phi \in Z_Q^2(X, A)$, the CJKLS invariant ([6, 12]) is a knot invariant. For each knot K this invariant is denoted $Z_{X,A,\phi}(K)$ or simply $Z(K)$, when the choice of X , A , and ϕ is clear. It can be regarded as a State-sum where the states are the homomorphisms (colorings) from the Fundamental Quandle ([8, 13]) of the knot under study to the labelling quandle, X . The CJKLS invariant takes values in the group algebra over the integers, $\mathbb{Z}[A]$, of the abelian group, A . Due to the features of this invariant, the integers involved in the expression of $Z(K)$ are non-negative, for each knot K . This group algebra, $\mathbb{Z}[A]$, embeds in the group algebra over the reals of the same finite abelian group, $\mathbb{R}[A]$. The latter is then regarded as a real vector space, whose dimension equals the order, N , of the finite abelian group, A . We identify this vector space with \mathbb{R}^N which, equipped with the Euclidean norm, is a closed metric space. We, thus, regard the CJKLS invariant as taking values in this closed metric space.

We next think of $Z(K)$ as being a vector State-sum or Partition Function in the Helmholtz Representation or Canonical Formalism ([4]). This means that each coordinate of the vector $Z(K) \in \mathbb{R}^N$ is regarded as a State-sum or Partition Function in the Helmholtz Representation or Canonical Formalism. We then proceed to extract the Free Energy, $F(K)$. This is the vector obtained by taking logarithms of each coordinate of $Z(K)$. We drop the “ $-kT$ ” factor in the expression of the Free Energy since it has no meaning in our set up. We also extend the logarithm to have the value zero at zero. Finally, we divide each coordinate of the Free Energy by the crossing number of K to obtain the Free Energy per crossing, $f(K)$. This should correspond to the Free Energy per site in Exactly Solved Models ([2]). We remark that this $f(K)$ is an invariant of K , for each knot K .

In this article we fix a labelling quandle, X , a finite abelian group, A , and a 2-cocycle, ϕ , and consider sequences of alternating knots whose crossing number strictly increases. For each such sequence, say (K_n) , we calculate the corresponding sequence of the f invariant, $(f(K_n))$. Mimicking the Thermodynamic Limit Procedure ([2]), we calculate the limit of $(f(K_n))$ as the crossing number goes to infinity. We obtain infinitely many *hyperfinite knots* in this way by showing that for infinitely many sequences (K_n) , $(f(K_n))$ converges.

The *hyperfinite knots* thus establish another liaison between Statistical Mechanics and Knot Theory. In this connection we would like to refer also to the works [1] and [16] which relate Exactly Solved Models ([2]) and Knot Theory ([9]).

In [10], Kauffman describes an operator which when iterated on a knot produces an infinite weaving pattern. He calls the result of this process an *infinite knot*. He formalizes this limit using a category of infinite sequences. We plan to investigate the relation of Kauffman’s *infinite knots* to our *hyperfinite knots* in future work.

1.3 Acknowledgements

The author acknowledges support by *Programa Operacional “Ciência, Tecnologia, Inovação”* (POCTI) of the *Fundação para a Ciência e a Tecnologia* (FCT) cofinanced by the European Community fund FEDER. He also thanks the staff at IMPA and especially his host, Marcelo Viana, for hospitality during his stay at this Institution.

2 The definition of hyperfinite knots

In this section we introduce the formal definitions of the objects we will be dealing with, **knots** and **hyperfinite knots**, and draw the distinction between them.

Definition 2.1 (Knot, [9]) A **knot** is an embedding of the standard circle, S^1 , into \mathbb{R}^3 . The image of the embedding may have any (finite) number of components. Thus, we also use the word **knot** for what is sometimes called **link** in the literature.

Definition 2.2 (Crossing number of a knot) Given a knot, K , its **crossing number**, c_K , is the least positive integer with the following property. There is no diagram of K with strictly less than c_K crossings.

Definition 2.3 (Hyperfiniteness) Consider a knot invariant which takes values in a closed metric space. Specifically, consider a map, f , from the set of knots (or one of its subsets), \mathcal{K} , into a closed metric space, \mathbf{M} , such that knots that are deformable into each other receive the same value of f .

Let \mathcal{K}_f be the quotient set of \mathcal{K} by the relation \sim :

$$K \sim K' \iff_{\text{def.}} f(K) = f(K')$$

In particular, knots that are deformable into each other lie in the same equivalence class. Given $K \in \mathcal{K}$, let $K^\sim \in \mathcal{K}_f$ be the equivalence class which contains K . Let f^\sim be the map from \mathcal{K}_f to M which sends K^\sim to $f(K)$. This map is an embedding of \mathcal{K}_f into M . We can thus regard \mathcal{K}_f as a subspace of M . Let $\overline{\mathcal{K}_f}$ denote the closure of \mathcal{K}_f with respect to the metric in \mathbf{M} .

Assume (K_n^\sim) is a sequence of knots from \mathcal{K}_f , with sequence of representatives (K_n) with increasing crossing number, such that for $n \neq n'$, $f(K_n) \neq f(K_{n'})$. Assume further that $(f(K_n))$ converges in M to, say fK_∞ . Then there exists an element of $\overline{\mathcal{K}_f}$, call it K_∞ which is the limit of (K_n^\sim) in $\overline{\mathcal{K}_f}$:

$$K_\infty = \lim_{n \rightarrow \infty} K_n^\sim$$

We call such limits **hyperfiniteness**.

Proposition 2.1 Keeping the notation above, fK_∞ is an invariant of K_∞ .

Proof: It follows from the definition of hyperfiniteness. ■

Loosely speaking, **hyperfiniteness** are limits of **knots** of increasing crossing number. Below, we will give an example of a proper **hyperfiniteness**, K_∞ , in the sense that $K_\infty \in \overline{\mathcal{K}_f} \setminus \mathcal{K}_f$.

3 Background on quandles and the CJKLS invariant

3.1 Quandles and the Fundamental Quandle of a Knot

Definition 3.1 A **quandle**, [8, 13], is a set, X , equipped with a binary operation, $*$, such that, for any $a, b, c \in X$

- $a * a = a$
- there is a unique $x \in X$ such that $x * b = a$
- $(a * b) * c = (a * c) * (b * c)$

The quandle formed by the set X and the binary operation $*$ will be denoted $(X, *)$.

We remark that the second axiom above gives rise to a second operation on the quandle denoted $\bar{*}$. Then, $a \bar{*} b$ is precisely the unique x guaranteed by the second axiom such that $x * b = a$.

The set of Laurent polynomials in a variable T , $\mathbb{Z}[T, T^{-1}]$, endowed with the operation

$$a * b := Ta + (1 - T)b \quad \text{for any } a, b \in \mathbb{Z}[T, T^{-1}]$$

is an example of a quandle with infinite elements. Quotients of the set of Laurent polynomials by appropriate ideals and endowed with the analogous binary operation, give rise to the so-called Alexander

quandles. We consider only the Alexander quandle we will be interested in, in this article. It is called S_4 . This is the set

$$\mathbb{Z}_2[T, T^{-1}]/(T^2 + T + 1)$$

endowed with the operation

$$a * b = Ta + (1 - T)b \quad \text{for any } a, b \in \mathbb{Z}_2[T, T^{-1}]/(T^2 + T + 1)$$

in the indicated quotient. As a set, $\mathbb{Z}_2[T, T^{-1}]/(T^2 + T + 1)$ has four elements whose representatives may be taken to be $0, 1, T, T + 1$. We calculate $1 * (T + 1)$:

$$1 * (T + 1) = T \cdot 1 + (1 - T) \cdot (T + 1) = T + T + 1 - T^2 - T = 2T + T^2 + T + 1 = 0$$

in the indicated quotient. Moreover, since, in the indicated quotient,

$$1 = T^2 + T = T(T + 1)$$

then

$$T^{-1} = T + 1$$

The three defining axioms of quandles are intimately related to the Reidemeister moves of Knot Theory ([9]).

Definition 3.2 *The Fundamental Quandle of a Knot, K , ([8, 13]) is presented as follows. Consider any diagram of K , say D_K , and endow it with an orientation and a consistent co-orientation (i.e., a normal at each point of the diagram). The arcs of D_K are regarded as generators and relations of the following sort are read at each crossing: “under-arc” * “over-arc” = “under-arc”, where the normal to the over-arc points to the under-arc which receives the product, see Figure 1.*

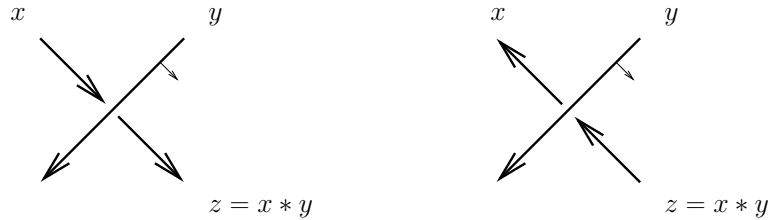

Figure 1: Relations read at crossings

Theorem 3.1 *The Fundamental Quandle of a knot is a classifying invariant of it.*

Proof: Omitted. See [8, 13]. ■

The fact that the Fundamental Quandle of a Knot K is an invariant of K is a straightforward consequence of the defining axioms of the quandle. Unfortunately, there is no universal algorithm which allows one to decide, after a finite number of steps, whether two presentations of a quandle are isomorphic or not. In this way, the Fundamental Quandle of a knot is, per se, of little practical use in telling knots apart.

3.2 Colorings by a labelling quandle

Notwithstanding, there is a simple way of obtaining a nice invariant from the Fundamental Quandle of the Knot. It relies on the notion of quandle homomorphism.

Definition 3.3 *Given quandles $(X, *)$ and $(X', *')$, a homomorphism from $(X, *)$ to $(X', *')$ is a map, f , from X to X' such that, for any $x, y \in X$,*

$$f(x * y) = f(x) *' f(y)$$

Definition 3.4 Given a knot, K , and a finite quandle, X , the **number of colorings of K by X** is the number of homomorphisms from the Fundamental Quandle of the Knot K to X .

In this set up, X is referred to as **labelling quandle**. The elements of the **labelling quandle** are also called **colors**.

We remark that there are always the so-called trivial colorings. These are the colorings where every element of the Fundamental Quandle of the knot is assigned the same element of the labelling quandle. There are then at least as many colorings as elements of the labelling quandle.

Proposition 3.1 Fix a knot K and a finite quandle X . The number of colorings of K by X is calculated in the following way. We consider the relations in the presentation of the Fundamental Quandle of the Knot as a system of equations over the quandle X . The number of solutions of this system of equations is the number of colorings of K by X . Since the Fundamental Quandle of the Knot is an invariant it then follows that the number of colorings by X is also an invariant. This number is always at least equal to the cardinality of the labelling quandle.

Proof: Omitted. See [7]. ■

This invariant was tested in [7] for its efficiency.

3.3 The CJKLS invariant

The CJKLS invariant can be regarded as an elaborated way of listing the colorings of a knot by a given finite labelling quandle.

Definition 3.5 (CJKLS invariant, [6, 12]) Choose a finite quandle X , a finite abelian group denoted multiplicatively, A , and a 2-cocycle $\phi \in Z_Q^2(X, A)$ i.e., a map ϕ from $X \times X$ to A , such that, for any $a, b, c \in X$

$$\phi(a, a) = 1 \quad \text{and} \quad \phi(a, b)\phi(a * b, c) = \phi(a, c)\phi(a * c, b * c)$$

where 1 is the identity in the group A .

Given a knot K , consider one of its diagrams, D_K , where the crossings are denoted by τ . Let \mathcal{C} denote the set of colorings of the knot K by the labelling quandle X . With respect to the data X , A , and ϕ , the CJKLS invariant of K is

$$Z_{X,A,\phi}(K) = \sum_{C \in \mathcal{C}} \prod_{\tau \in D_K} \phi(a_C, b_C)^{\epsilon_\tau}$$

where $\epsilon_\tau = \pm 1$ and the meaning of $\phi(a_C, b_C)^{\epsilon_\tau}$ is explained in Figure 2. When the choice of X , A , and ϕ is clear we will write $Z(K)$ for $Z_{X,A,\phi}(K)$.



Figure 2: The two possible evaluations of ϕ at a crossing (a_C and b_C are part of an overall coloring C).

Theorem 3.2 Keeping the notation above, for each knot K , $Z(K)$ is an invariant of K .

Proof: Omitted. See [6, 12]. ■

The fact that, for each knot K , $Z(K)$ is an invariant of K stems from the fact that for each coloring $C \in \mathcal{C}$ the product

$$\prod_{\tau \in D_K} \phi(a_C, b_C)^{\epsilon_\tau}$$

is invariant under the Reidemeister moves. Unfortunately, since there is no canonical ordering of the colorings we have to consider all colorings. Therefore we have to sum the products over all colorings ([6]) or simply to list them over all colorings ([12]).

We remark that, for any choice of X and A , there is always the so-called trivial 2-cocycle in $Z_Q^2(X, A)$:

$$\phi_0 \equiv 1$$

where 1 is the identity element in the abelian, multiplicative group A . With such a ϕ_0 the products in the expression of Z all become equal to 1. Then $Z_{X,A,\phi_0}(K)$ yields the number of colorings of K by the labelling quandle X .

3.4 An invariant of knots stemming from the CJKLS invariant

For the remainder of this Subsection, we assume, without loss of generality, that the following have been fixed. A finite quandle X ; a finite abelian group A , of order N ; a 2-cocycle ϕ .

Definition 3.6 (CJKLS invariant, 2nd version) *According to Definition 3.5, the CJKLS invariant of any knot K has the form,*

$$Z(K) = n_1 g_1 + n_2 g_2 + \cdots + n_N g_N$$

where the finite abelian group

$$A = \{g_1, g_2, \dots, g_N\}$$

is ordered in a definite way, and, for each $i = 1, 2, \dots, N$,

$$n_i = \#\{C \in \mathcal{C} \mid \prod_{\tau \in D_K} \phi(a_C, b_C)^{\epsilon_\tau} = g_i\} \quad (\geq 0)$$

keeping the notation in Definition 3.5.

$Z(K)$ is then an element of $\mathbb{Z}[A]$, the group algebra of A over the integers. This group algebra embeds in the obvious way in $\mathbb{R}[A]$ the group algebra of A over the reals. The latter can be regarded as a real vector space of dimension N , so we identify it with \mathbb{R}^N .

In this way, our second version of the CJKLS invariant is, for any knot K , to define it in the following way

$$Z(K) := (n_1, n_2, \dots, n_N)$$

regarded as the (non-negative) coordinates of a vector in \mathbb{R}^N with respect to the canonical basis and where

$$n_i = \#\{C \in \mathcal{C} \mid \prod_{\tau \in D_K} \phi(a_C, b_C)^{\epsilon_\tau} = g_i\}$$

for each $i = 1, 2, \dots, N$, keeping the notation above.

We will interchangeably use one or the other versions of the CJKLS invariant.

Proposition 3.2 *We keep the notation above. For any knot K , the sum*

$$\sum_{i=1}^N n_i$$

equals the number of colorings of the knot by the labelling quandle. In particular, for at least one i

$$n_i > 0$$

Proof: Assume

$$Z(K) = n_1 g_1 + \cdots + n_N g_N$$

If we set each of the g_i 's equal to 1 this corresponds to using the trivial 2-cocycle. But with this choice of 2-cocycle, $Z(K)$ yields the number of colorings. The result follows. \blacksquare

Definition 3.7 We extend the natural logarithm to zero with value zero and we use the same symbol “ln” to denote the extended function.

Definition 3.8 We keep the notation of Definition 3.6, above.
We define, for any knot K ,

$$F(K) := (\ln(n_1), \ln(n_2), \dots, \ln(n_N))$$

and

$$f(K) := \left(\frac{\ln(n_1)}{c_K}, \frac{\ln(n_2)}{c_K}, \dots, \frac{\ln(n_N)}{c_K} \right)$$

where c_K is the crossing number of K , and

$$n_i = \#\{ C \in \mathcal{C} \mid \prod_{\tau \in D_K} \phi(a_C, b_C)^{\epsilon_\tau} = g_i \}$$

for each $i = 1, 2, \dots, N$.

Proposition 3.3 For each knot K , $F(K)$ and $f(K)$ are invariants of knots which take values in the closed metric space \mathbb{R}^N , keeping the notation above.

Proof: Omitted. ■

We will be particularly interested in the f invariant in the sequel.

3.5 Calculating the CJKLS invariant and the f invariant

In [5] we find the labelling quandle, X , the abelian group, A , and the 2-cocycle, ϕ , we will be working with in this article.

The labelling quandle, X , is the so-called S_4 (page 47) which is identified with the Alexander quandle $\mathbb{Z}_2[T, T^{-1}]/(T^2 + T + 1)$ (page 48) with quandle operation

$$a * b := Ta + (1 - T)b$$

in the indicated quotient.

The abelian group, A , is $\mathbb{Z}_2 \cong (t \mid t^2)$ and the 2-cocycle, ϕ , is (page 52):

$$\phi(a, b) := t^{\chi_{(0,1)}(a,b) + \chi_{(0,T+1)}(a,b) + \chi_{(1,0)}(a,b) + \chi_{(1,T+1)}(a,b) + \chi_{(T+1,0)}(a,b) + \chi_{(T+1,0)}(a,b)}$$

Definition 3.9 In the sequel **CJKLS invariant** will mean the CJKLS invariant with the choice of X , A , and ϕ above.

The invariants F and f , introduced in Definition 3.8 will also refer to this choice of X , A , and ϕ .

Moreover, when using the second version of the CJKLS invariant we will order $A \cong (t \mid t^2)$ so that $g_1 = 1$ and $g_2 = t$. Since the cardinality of this group is 2, then $N = 2$ and the underlying closed metric space is \mathbb{R}^2 endowed with the Euclidean metric.

We now evaluate the CJKLS invariant and the f invariant of the trefoil knot and of its mirror image.

The trefoil can be regarded as the closure of the braid $\sigma_1^3 \in B_2$ ([3]), which is the braid depicted in Figure 3. We start by listing the possible colorings by S_4 . In order to do that, we assign generic colors $a, b \in S_4$ to the top strands of the braid in Figure 3 and calculate how they propagate through each crossing. We enumerate crossings from top to bottom 1, 2, and 3. The orientation on the strands of the braid is downwards and the co-orientation is to the left.

The arc emerging from the first crossing is assigned color

$$a * b = Ta + (1 - T)b$$

The arc emerging from the second crossing is assigned color

$$b * (Ta + (1 - T)b) = Tb + (1 - T)[Ta + (1 - T)b] = (T^2 + T)a + (T^2 + T + 1 + 2T)b = a$$

in the indicated quotient. Finally, the arc emerging from the third crossing is assigned color

$$(Ta + (1 - T)b) * a = \dots = b$$

again, in the indicated quotient. Then, the colors of the strands at the bottom match the colors of the corresponding strands at the top, when we close the braid in order to obtain the trefoil. In this way, any choice of a and b from S_4 gives rise to a coloring of the trefoil. Since S_4 has four elements, the number of colorings is $4^2 = 16$.

We remark that for a general labelling quandle, what we obtain for colors at the bottom strands are polynomials in the color inputs at the top strands. When we equate each of these polynomials to the corresponding color at the top we obtain a system of equations in the input colors ([7]). The number of solutions of this system of equations is then the number of colorings. In the present case the system of equations is

$$\begin{cases} a = a \\ b = b \end{cases}$$

We now calculate, for each $(a, b) \in S_4 \times S_4$, the corresponding product of the ϕ 's over the crossings of the diagram. The left-hand side of Figure 3 indicates how to evaluate ϕ at each crossing.

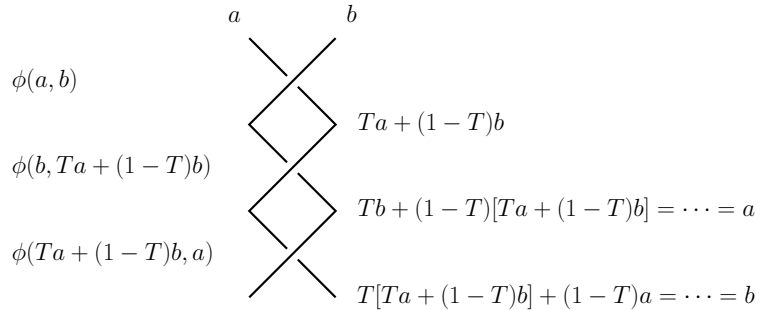

Figure 3: The colorings and evaluation of the 2-cocycle at crossings for the trefoil

In this way,

$$Z(\text{Trefoil}) = \sum_{a, b \in \{0, 1, T, 1+T\}} \phi(a, b) \cdot \phi(b, Ta + (1 - T)b) \cdot \phi(Ta + (1 - T)b, a)$$

We recall that the ϕ we are using is a function of two variables from S_4 and takes on values in $Z_2 \cong (t | t^2)$. Specifically, it takes on 1 when the two variables are equal or either one of them equals $T \in S_4$; it takes on t , otherwise. We then set

$$\Phi(a, b) := \phi(a, b) \cdot \phi(b, Ta + (1 - T)b) \cdot \phi(Ta + (1 - T)b, a)$$

It is a straightforward exercise to see that

$$\Phi(a, b) = \begin{cases} 1, & \text{if } a = b \\ t, & \text{if } a \neq b \end{cases}$$

Thus

$$\Phi(a, b) = t^{\bar{\delta}_{a,b}}$$

with

$$\bar{\delta}_{a,b} = \begin{cases} 0, & a = b \\ 1, & a \neq b \end{cases}$$

and so

$$Z(\text{Trefoil}) = \sum_{a, b \in \{0, 1, T, 1+T\}} t^{\bar{\delta}_{a,b}} = 4t^0 + 12t = 4(1 + 3t)$$

Now for the mirror image of the trefoil knot. Note that in S_4

$$a\bar{x}b = T^{-1}a + (1 - T^{-1})b = (T + 1)a + Tb$$

as remarked above. We believe that Figure 4 is now self-explanatory.

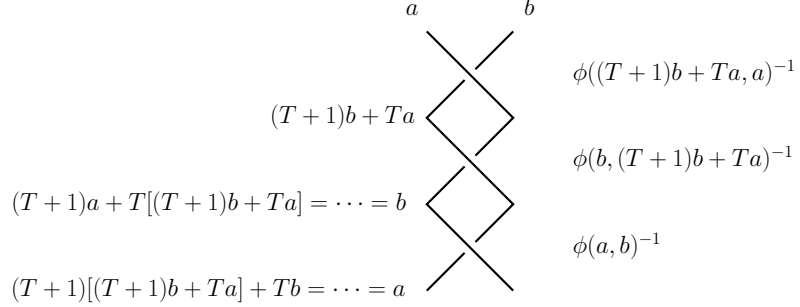

Figure 4: The colorings and evaluation of the ϕ map at crossings for the mirror image of the trefoil

Then the CJKLS invariant of the mirror image of the trefoil knot is:

$$\begin{aligned} \sum_{a,b \in \{0,1,T,1+T\}} \phi(Ta + (1 - T)b, a)^{-1} \cdot \phi(b, Ta + (1 - T)b)^{-1} \cdot \phi(a, b)^{-1} &= \sum_{a,b \in \{0,1,T,1+T\}} \Phi(a, b)^{-1} \\ &= \sum_{a,b \in \{0,1,T,1+T\}} \Phi(a, b) = 4(1 + 3t) \end{aligned}$$

where the equality before the last one follows since Φ takes values in \mathbb{Z}_2 . Then the CJKLS invariant of both the trefoil and of its mirror image is $4(1 + 3t)$.

With our current choice of X , A and ϕ , the CJKLS invariant is assumed to take values in \mathbb{R}^2 , the first coordinate corresponding to the identity element in $A = \mathbb{Z}_2$ and the second coordinate corresponding to the other element of A (Definition 3.9). In this way,

$$f(\text{Trefoil}) = \left(\frac{\ln(4)}{3}, \frac{\ln(12)}{3} \right) = \left(\frac{2 \ln(2)}{3}, \frac{2 \ln(2) + \ln(3)}{3} \right)$$

and the same for the mirror image of the trefoil.

At this point, we record for later use a result whose proof is implicit in the preceding discussion:

Proposition 3.4 *Suppose we are calculating the CJKLS invariant of a given knot using one of its diagrams. In particular, this diagram has been assigned a coloring by S_4 . Assume further that a certain portion of this diagram looks like $\sigma_i^{\pm 3}$ and the colors assigned at the top strands of this $\sigma_i^{\pm 3}$ are a_{i-1}, a_i , from left to right, see Figure 5. Then the colors at the bottom strands of this $\sigma_i^{\pm 3}$ are a_{i-1}, a_i , from left to right. Moreover, the contribution of the three crossings of this $\sigma_i^{\pm 3}$ in the coloring under study for the summand of the CJKLS invariant corresponding to this coloring is the factor*

$$\Phi(a_{i-1}, a_i)$$

Proof: Omitted. ■

4 Sequences of alternating knots

In this Section we describe some sequences of alternating knots (Subsections 4.2, 4.3, 4.4, and 4.5), calculate the corresponding sequences of the f invariant and their limits. The existence of these limits will imply the existence of hyperfinite knots, as explained in Section 2. Before, we define alternating knots and some other particulars of alternating knots which will concern us in the sequel. We remark that we use the word *knot* to mean both one- or multi-component knots.

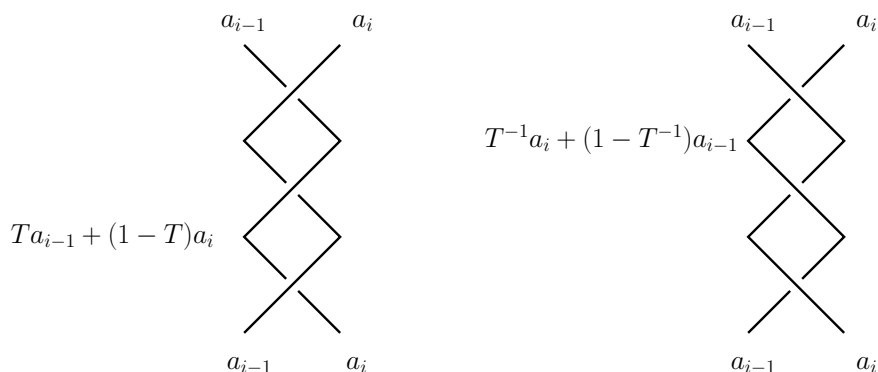

Figure 5: The colors of a coloring of $\sigma_i^{\pm 3}$ by S_4

4.1 Alternating knots

Definition 4.1 (Alternating knot) An **alternating knot** is a knot such that one of its diagrams possesses the following property. Travelling along the diagram, starting at a given point and coming back to it, and recording at each crossing whether it was passed over or under, an alternating sequence of “over”s and “under”s is obtained. The **trefoil** (Figure 3) is an example of an alternating knot.

Definition 4.2 (Smoothing of a crossing) Given a knot diagram, any crossing of it can be **smoothed** in two different ways, see Figure 6.

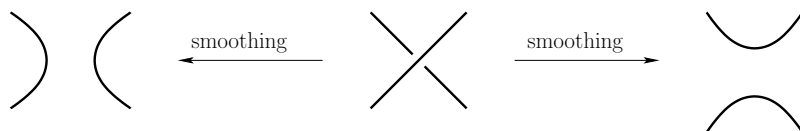

Figure 6: The two possible smoothings of a crossing

Definition 4.3 A **nugatory crossing** of a diagram is a crossing such that one of its two smoothings disconnects the diagram, see Figure 7. The blank areas surrounded by dotted lines in this Figure stand for unspecified regions of the diagram.

Definition 4.4 A **reduced diagram** does not have any **nugatory crossings**.

In the sequel, we will need the following property of alternating knots.

Theorem 4.1 Any two reduced, alternating diagrams of a knot, K , have the same number of crossings. This number is then an invariant of K , the **crossing number** of K .

Proof: Omitted. See [11], [14], or [15]. ■

We now describe sequences of alternating knots of increasing crossing number that give rise to hyperfinite knots in the way described in Section 2.

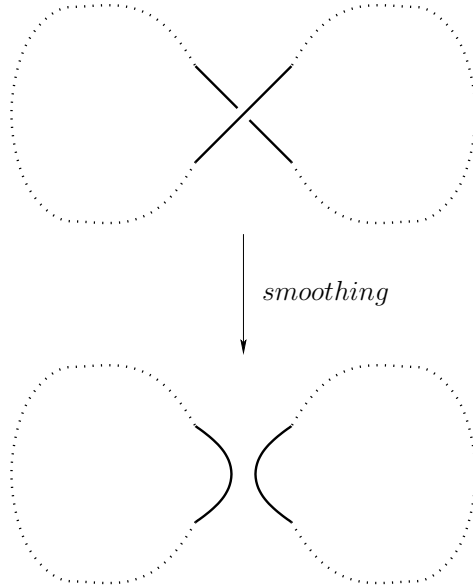

Figure 7: A nugatory crossing and the smoothing which reveals its nature

4.2 The K_n Sequence

Definition 4.5 (The K_n Sequence) *This sequence of alternating knots of increasing crossing number is given by the closure of the following braids.*

$$\begin{aligned}
 b_1 &= \sigma_1^3, & \sigma_1 &\in B_2 \\
 b_2 &= \sigma_2^{-3} \cdot \sigma_1^3 \cdot \sigma_2^{-3}, & \sigma_1, \sigma_2 &\in B_3 \\
 b_3 &= \sigma_3^3 \cdot \sigma_2^{-3} \cdot \sigma_1^3 \cdot \sigma_2^{-3} \cdot \sigma_3^3, & \sigma_1, \sigma_2, \sigma_3 &\in B_4 \\
 & \vdots \\
 b_n &= \sigma_n^{(-1)^{n+1}3} \cdot \dots \cdot \sigma_3^3 \cdot \sigma_2^{-3} \cdot \sigma_1^3 \cdot \sigma_2^{-3} \cdot \sigma_3^3 \cdot \dots \cdot \sigma_n^{(-1)^{n+1}3}, & \sigma_1, \dots, \sigma_n &\in B_{n+1}
 \end{aligned}$$

In this sequence, K_1 is the trefoil, regarded as the closure of the braid b_1 depicted in Figure 3. K_2 is the closure of braid b_2 depicted in Figure 8, and K_3 is the closure of braid b_3 depicted in Figure 9. In this way, the reader should by now realize how the general K_n looks like. We remark that for any n , the closure of b_n is a reduced alternating diagram. Its number of crossings is then the crossing number of K_n , according to Theorem 4.1.

As calculated in Section 3.5, any input (a, b) ($a, b \in S_4$) at the top of the σ_1^3 propagates downwards eventually becoming (a, b) at the bottom of the braid. In this way there are $4^2 = 16$ colorings of the trefoil by S_4 and the CJKLS invariant is then

$$Z(\text{Trefoil}) = \sum_{a, b \in \{0, 1, T, T+1\}} t^{\delta_{a, b}} = 4(1 + 3t)$$

where t is the generator of the target group $\mathbb{Z}_2 \cong (t | t^2)$. So

$$Z(K_1) = 4 + 12t \qquad f(K_1) = \left(\frac{2 \ln(2)}{3}, \frac{2 \ln(2) + \ln(3)}{3} \right)$$

The knot K_2 is the closure of the braid b_2 depicted in Figure 8. Let us first discuss the colorings and the contribution of each part of the braiding for the CJKLS invariant, leaning on Proposition 3.4. The

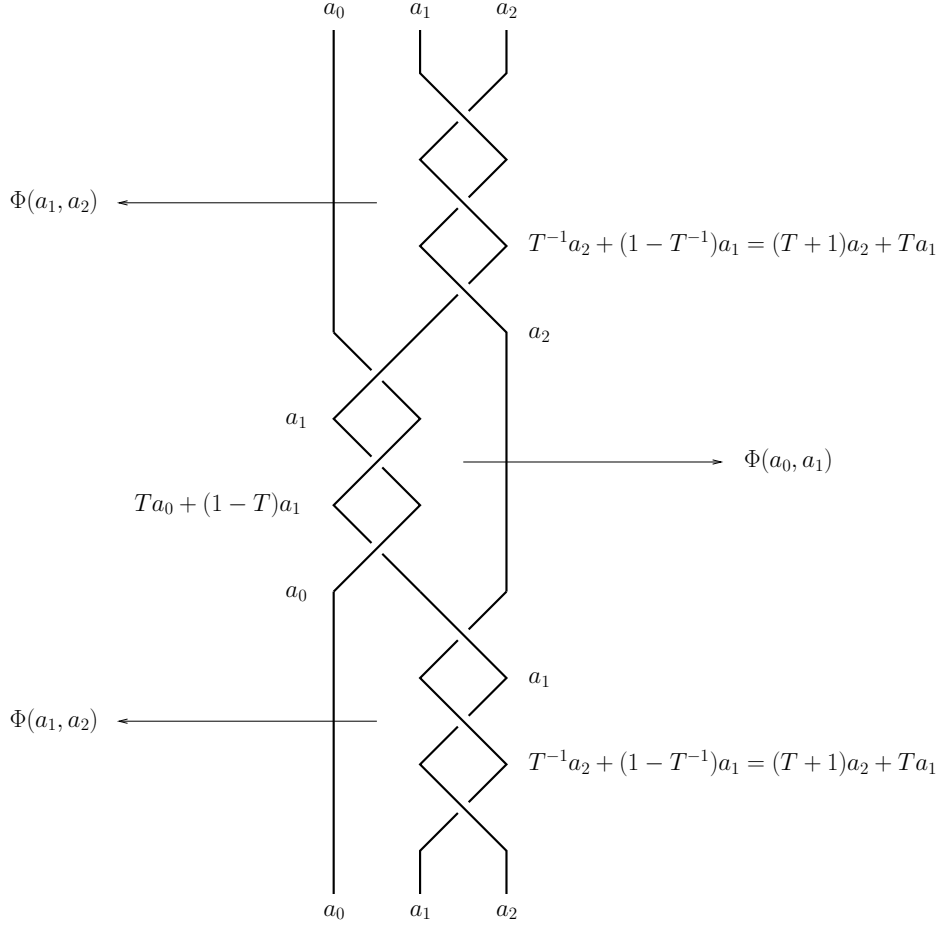

Figure 8: K_2 , upon closure of the braid, endowed with a coloring by S_4 , plus the Φ contributions to the CJKLS invariant

color input is formed by three colors from S_4 , a_0, a_1, a_2 . The two top right colors a_1, a_2 propagate down a σ_2^{-3} and so the colors at the bottom of this σ_2^{-3} are a_1, a_2 , according to Proposition 3.4. Moreover, the contribution of this σ_2^{-3} to the CJKLS invariant of K_2 is $\Phi(a_1, a_2)$, according to the same Proposition. We now have colors a_0, a_1 as inputs to σ_1^3 . These colors propagate through σ_1^3 and so at the bottom of it the colors are a_0, a_1 . The contribution of this σ_1^3 to the CJKLS invariant of K_2 is $\Phi(a_0, a_1)$. Finally, there are colors a_1, a_2 at the top of σ_2^{-3} and, arguing as before, the contribution of this σ_2^{-3} to the CJKLS invariant of K_2 is $\Phi(a_1, a_2)$. The CJKLS invariant of K_2 is then

$$\begin{aligned}
Z(K_2) &= \sum_{a_0, a_1, a_2 \in \{0, 1, T, T+1\}} \Phi(a_1, a_2) \cdot \Phi(a_0, a_1) \cdot \Phi(a_1, a_2) = \sum_{a_0, a_1, a_2 \in \{0, 1, T, T+1\}} \Phi(a_0, a_1) = \\
&= \sum_{a_0, a_1, a_2 \in \{0, 1, T, T+1\}} t^{\delta_{a_0, a_1}} = 4 \cdot \sum_{a_0, a_1 \in \{0, 1, T, T+1\}} t^{\delta_{a_0, a_1}} = 4 \cdot 4(1 + 3t) = 4^2(1 + 3t)
\end{aligned}$$

In this way,

$$Z(K_2) = 4^2(1 + 3t) \quad f(K_2) = \left(\frac{4 \ln(2)}{9}, \frac{4 \ln(2) + \ln(3)}{9} \right)$$

The term K_3 is the closure of the braid depicted in Figure 9. We believe it to be clear now that for any given integer $n > 2$, the contributions from each coloring to the CJKLS invariant of K_n come from the $\Phi(a_0, a_1)$ associated to the σ_1^3 , since all other factors $\Phi(a_{i-1}, a_i)$ come in pairs and are thus equal to

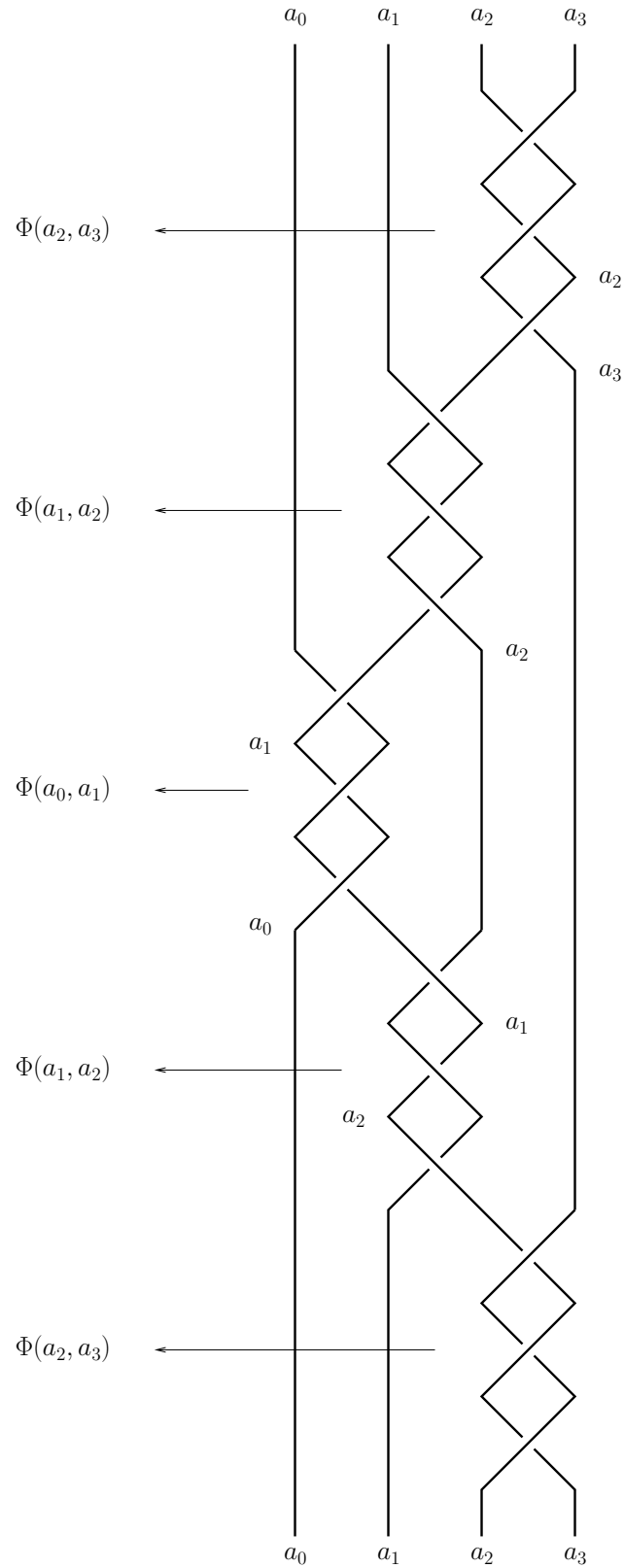

Figure 9: K_3 , upon closure of the braid, endowed with a coloring by S_4 , plus the Φ contributions to the CJKLS invariant

1 in \mathbb{Z}_2 . Then

$$Z(K_n) = \sum_{a_0, \dots, a_n \in S_4} \Phi(a_0, a_1) = \sum_{a_0, \dots, a_n \in \{0, 1, T, T+1\}} t^{\bar{\delta}_{a,b}} = 4^{n-1} \cdot 4(1+3t) = 4^n(1+3t)$$

The crossing number of K_n is:

$$3 \left(\sum_{k=1}^n 2 - 1 \right) = 6n - 3$$

We now calculate the f invariant of K_n :

$$f(K_n) = \left(\frac{\ln(4^n)}{6n-3}, \frac{\ln(3 \cdot 4^n)}{6n-3} \right) = \left(\frac{(2n) \ln(2)}{6n-3}, \frac{2n \ln(2) + \ln(3)}{6n-3} \right)$$

Thus,

$$Z(K_n) = 4^n(1+3t) \quad f(K_n) = \left(\frac{(2n) \ln(2)}{6n-3}, \frac{2n \ln(2) + \ln(3)}{6n-3} \right)$$

Finally,

$$\lim_{n \rightarrow \infty} f(K_n) = \lim_{n \rightarrow \infty} \left(\frac{(2n) \ln(2)}{6n-3}, \frac{2n \ln(2) + \ln(3)}{6n-3} \right) = \left(\frac{\ln(2)}{3}, \frac{\ln(2)}{3} \right)$$

In this way, the sequence (K_n^\sim) converges to the hyperfinite knot K_∞ ,

$$K_\infty = \lim_{n \rightarrow \infty} K_n^\sim$$

whose f invariant is

$$fK_\infty = \left(\frac{\ln(2)}{3}, \frac{\ln(2)}{3} \right)$$

4.3 The K'_n Sequence

Definition 4.6 (The K'_n Sequence) *This sequence of alternating knots of increasing crossing number is given by the closure of the following braids.*

$$b'_1 = b_1 \quad b'_2 = b_2 \quad b'_3 = \sigma_3^3 \sigma_2^{-3} \sigma_1^3 \sigma_3^3 \sigma_2^{-3} \sigma_3^3 \quad b'_4 = \sigma_4^{-3} \sigma_3^3 \sigma_2^{-3} \sigma_1^3 \sigma_3^3 \sigma_2^{-3} \sigma_3^3 \sigma_4^{-3}$$

and in general

$$b'_{2i+1} = \sigma_{2i+1}^3 \sigma_{2i}^{-3} \sigma_{2i-1}^3 \cdots \sigma_3^3 \sigma_2^{-3} \cdots \sigma_1^3 \sigma_3^3 \cdots \sigma_{2i-1}^3 \sigma_{2i+1}^3 \cdots \sigma_2^{-3} \sigma_3^3 \cdots \sigma_{2i-1}^3 \sigma_{2i}^{-3} \sigma_{2i}^3$$

and

$$b'_{2i+2} = \sigma_{2i+2}^{-3} b'_{2i+1} \sigma_{2i+2}^{-3}$$

We believe the sequence is now clear with the help of Figures 10, 11, and 12 which depict b'_3 , b'_4 , and b'_5 .

We remark also that for each n , the closure of b'_n is a reduced alternating diagram. Thus, the number of crossings of b'_n is the crossing number of K'_n .

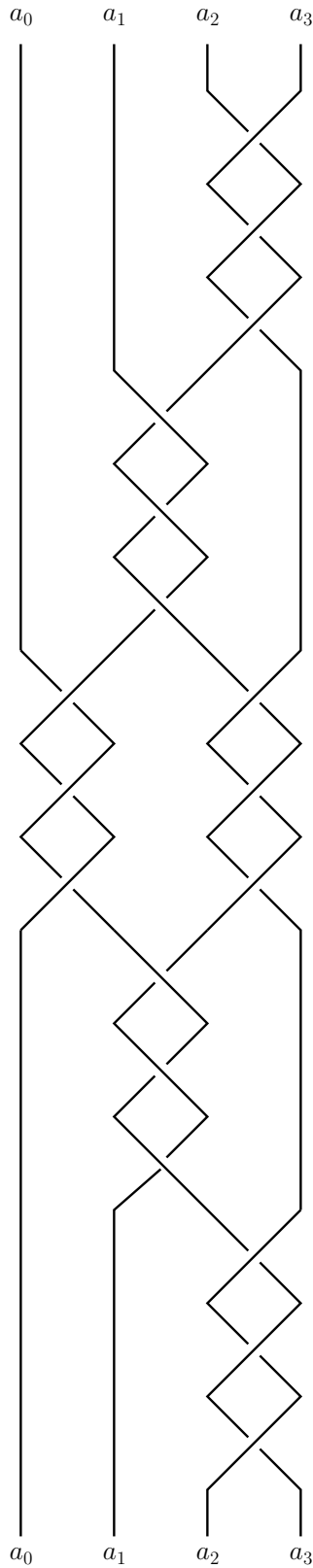

Figure 10: K'_3 , upon closure of the braid, endowed with a coloring by S_4

For odd n , the CJKLS invariant is

$$Z(K'_n) = \sum_{a_0, \dots, a_n \in \{0, 1, T, 1+T\}} \Phi(a_0, a_1) \cdot \Phi(a_2, a_3) \cdots \Phi(a_{n-1}, a_n) = \cdots$$

where the equality above follows from the fact that the Φ contributions from the remaining $\sigma_i^{\pm 3}$ come in pairs and so do not matter.

$$\dots = \sum_{a_0, \dots, a_n \in \{0, 1, T, 1+T\}} t^{\bar{\delta}_{a_0, a_1}} \cdot t^{\bar{\delta}_{a_2, a_3}} \dots \cdot t^{\bar{\delta}_{a_{n-1}, a_n}} = \dots$$

We now rewrite this sum in the following way. We write it over the number, k , of pairs (a_{2i}, a_{2i+1}) , for $i = 0, \dots, \frac{n-1}{2}$, such that $a_{i-1} \neq a_i$. We recall that n is odd. We will now count how many possibilities there are corresponding to k pairs (a_{2i}, a_{2i+1}) with $a_{2i} \neq a_{2i+1}$. The set

$$\{(a_0, a_1), (a_2, a_3), (a_4, a_5), \dots, (a_{n-1}, a_n)\}$$

has $\frac{n+1}{2}$ elements. There are then

$$\binom{(n+1)/2}{k}$$

distinct ways of obtaining exactly k pairs (a_{2i}, a_{2i+1}) with distinct coordinates. Since the quandle S_4 has four elements, for each such pair, a_{2i} can assume one of four elements, whereas a_{2i+1} can only assume one of the remaining three elements. The contribution from k such pairs is $(4 \cdot 3)^k$. Each of the remaining $\frac{n+1}{2} - k$ pairs has equal coordinates. This can be realized in four distinct ways for each of them. In this way, there are

$$\binom{(n+1)/2}{k} \cdot (4 \cdot 3)^k \cdot 4^{(n+1)/2-k}$$

distinct ways of realizing exactly k pairs (a_{2i}, a_{2i+1}) with distinct coordinates. Given k , the contribution of the Φ 's to the CJKLS invariant, in each of these $\binom{(n+1)/2}{k} \cdot (4 \cdot 3)^k \cdot 4^{(n+1)/2-k}$ possibilities is t^k from the pairs with distinct coordinates and $1^{(n+1)/2-k}$ from the pairs with equal coordinates. In this way, returning to the evaluation of the CJKLS invariant:

$$\begin{aligned} \dots &= \sum_{k=0}^{(n+1)/2} \binom{(n+1)/2}{k} \cdot (4 \cdot 3)^k \cdot 4^{(n+1)/2-k} \cdot t^k = 4^{(n+1)/2} \cdot \sum_{k=0}^{(n+1)/2} \binom{(n+1)/2}{k} \cdot 3^k \cdot t^k = \\ &= 4^{(n+1)/2} \cdot \sum_{k=0, k \text{ even}}^{(n+1)/2} \binom{(n+1)/2}{k} \cdot 3^k + t \cdot 4^{(n+1)/2} \cdot \sum_{k=0, k \text{ odd}}^{(n+1)/2} \binom{(n+1)/2}{k} \cdot 3^k = \\ &= 4^{(n+1)/2} \cdot S_{(n+1)/2}^e + t \cdot 4^{(n+1)/2} \cdot S_{(n+1)/2}^o \end{aligned}$$

where

$$S_m^e := \sum_{k=0, k \text{ even}}^m \binom{m}{k} \cdot 3^k$$

and

$$S_m^o = \sum_{k=0, k \text{ odd}}^m \binom{m}{k} \cdot 3^k$$

The next result will be useful in the sequel.

Claim 4.1 *For integer $m > 2$,*

$$3^m < S_m^i < 4^m$$

for both $i = e$ and $i = o$.

Proof: The second inequality is a consequence of $S_m^e, S_m^o > 0$ and

$$S_m^e + S_m^o = (3 + 1)^m = 4^m$$

As for the first one, let $m > 2$ be even.

$$\begin{aligned} \sum_{k=0}^m \binom{m}{k} \cdot 3^k &= \left[\binom{m}{0} \cdot 3^0 + \binom{m}{2} \cdot 3^2 + \cdots + \binom{m}{m} \cdot 3^m \right] + \left[\binom{m}{1} \cdot 3^1 + \cdots + \binom{m}{m-1} \cdot 3^{m-1} \right] = \\ &= \left[1 + \frac{m(m-1)}{2} \cdot 3^2 + \cdots + 3^m \right] + \left[m \cdot 3 + \cdots + m \cdot 3^{m-1} \right] \end{aligned}$$

Inside each pair of square brackets we find either the summands corresponding to even k or to odd k . Since the last summand inside the first pair of square brackets is 3^m and inside the second pair it is $m \cdot 3^{m-1}$ ($m > 2$), the result follows for even $m > 2$. Observing that an analogous calculation holds for odd $m > 2$, we conclude the proof. \blacksquare

We saw above that, for odd n , the CJKLS invariant of (K'_n) is represented by

$$\left(4^{(n+1)/2} \cdot S_{(n+1)/2}^e, \quad 4^{(n+1)/2} \cdot S_{(n+1)/2}^o \right)$$

Since the crossing number of K'_n is, for odd n

$$3 \left(\sum_{k=1}^n 2 - 1 \right) + 3 \left(\frac{n+1}{2} - 1 \right) = \frac{12n - 6 + 3n + 3 - 6}{2} = \frac{15n - 9}{2}$$

we then have, for odd n ,

$$f(K'_n) = \left(\frac{\ln(4^{(n+1)/2} \cdot S_{(n+1)/2}^e)}{\frac{15n-9}{2}}, \frac{\ln(4^{(n+1)/2} \cdot S_{(n+1)/2}^o)}{\frac{15n-9}{2}} \right)$$

For even n , we obtain similarly for the CJKLS invariant of (K'_n) ,

$$\left(4^{n/2+1} \cdot S_{n/2}^e, \quad 4^{n/2+1} \cdot S_{n/2}^o \right)$$

and so, for even n

$$f(K'_n) = \left(\frac{\ln(4^{n/2+1} \cdot S_{n/2}^e)}{\frac{15n-12}{2}}, \frac{\ln(4^{n/2+1} \cdot S_{n/2}^o)}{\frac{15n-12}{2}} \right)$$

Thanks to Claim 4.1 above, for odd n ,

$$0 < \frac{\ln(12)}{15} \xleftarrow{n \rightarrow \infty} \frac{\frac{n+1}{2} \ln(12)}{\frac{15n-9}{2}} \leq \frac{\ln(4^{(n+1)/2} \cdot S_{(n+1)/2}^i)}{\frac{15n-9}{2}} \leq \frac{2(n+1) \ln(2)}{\frac{15n-9}{2}} \xrightarrow{n \rightarrow \infty} \frac{4 \ln(2)}{15} < \frac{\ln(2)}{3}$$

and analogously, for even n

$$0 < \frac{\ln(12)}{15} \xleftarrow{n \rightarrow \infty} \frac{\frac{n+1}{2} \ln(12) + 2 \ln(2)}{\frac{15n-12}{2}} \leq \frac{\ln(4^{n/2+1} \cdot S_{n/2}^i)}{\frac{15n-12}{2}} \leq \frac{2(n+1) \ln(2)}{\frac{15n-12}{2}} \xrightarrow{n \rightarrow \infty} \frac{4 \ln(2)}{15} < \frac{\ln(2)}{3}$$

We can then conclude that the sequence $(f(K'_n))$ is bounded and so there has to be a convergent subsequence of it which we denote again by $(f(K'_n))$. We can also conclude that the limit of this convergent sequence, call it fK'_∞ , is such that

$$(0, 0) \neq fK'_\infty \neq fK_\infty$$

In this way, the hyperfinite knot

$$K'_\infty = \lim_{n \rightarrow \infty} K'_n \sim$$

is different from the hyperfinite knot K_∞ obtained in the preceding subsection. Moreover, its f invariant is not $(0, 0)$.

So far we showed that there are at least two distinct *hyperfinite knots*.

In the next Subsection we show that the notion of *hyperfinite knot* is non-trivial.

4.4 The K_n^0 Sequence

In this subsection we present a sequence of knots whose f invariant tends to $(0, 0)$.

Definition 4.7 (The K_n^0 Sequence) *This sequence of alternating knots of increasing crossing number is given by the closure of the braids:*

$$\begin{aligned} b_1^0 &= \sigma_1^3 & \sigma_1 &\in B_2 \\ b_2^0 &= \sigma_1^{-3} \sigma_3^{-3} \sigma_2^3 \sigma_3^{-3} \sigma_1^{-3} & \sigma_1, \sigma_2, \sigma_3 &\in B_4 \\ b_3^0 &= \sigma_1^3 \sigma_3^3 \sigma_5^3 \sigma_2^{-3} \sigma_4^{-3} \sigma_3 \sigma_2^{-3} \sigma_4^{-3} \sigma_1^3 \sigma_3^3 \sigma_5^3 & \sigma_1, \sigma_2, \sigma_3, \sigma_4, \sigma_5 &\in B_6 \end{aligned}$$

and in general, for even n ,

$$b_n^0 = \sigma_1^{-3} \sigma_3^{-3} \cdots \sigma_{2n-1}^{-3} \sigma_2^3 \sigma_4^3 \cdots \sigma_{2n-2}^3 \cdots \sigma_n^3 \cdots \sigma_2^3 \sigma_4^3 \cdots \sigma_{2n-2}^3 \sigma_1^{-3} \sigma_3^{-3} \cdots \sigma_{2n-1}^{-3} \quad \sigma_1, \dots, \sigma_{2n-1} \in B_{2n}$$

and for odd n ,

$$b_n^0 = \sigma_1^3 \sigma_3^3 \cdots \sigma_{2n-1}^3 \sigma_2^{-3} \sigma_4^{-3} \cdots \sigma_{2n-2}^{-3} \cdots \sigma_n^3 \cdots \sigma_2^{-3} \sigma_4^{-3} \cdots \sigma_{2n-2}^{-3} \sigma_1^3 \sigma_3^3 \cdots \sigma_{2n-1}^3 \quad \sigma_1, \dots, \sigma_{2n-1} \in B_{2n}$$

Figures 13 and 14 should help visualize the general K_n^0 . The minimum number of crossings of K_n^0 is

$$3 \left(\sum_{k=1}^n 2k - 1 \right) = 3 \left(2 \frac{(n+1)n}{2} - 1 \right) = 3n^2 + 3n - 3$$

Moreover, using the same sort of analysis as above, the CJKLS invariant is here

$$Z(K_n^0) = 4^{2n-2} \cdot 4(1 + 3t)$$

thus the f invariant is

$$f(K_n^0) = \left(\frac{\ln(4^{2n-2} \cdot 4)}{3n^2 + 3n - 3}, \frac{\ln(4^{2n-2} \cdot 4 \cdot 3)}{3n^2 + 3n - 3} \right) = \left(\frac{(4n-4) \ln(4)}{3n^2 + 3n - 3}, \frac{(4n-4) \ln(2) + \ln(3)}{3n^2 + 3n - 3} \right)$$

and so

$$\lim_{n \rightarrow \infty} f(K_n^0) = (0, 0)$$

There exists then an hyperfinite knot K_∞^0 which is the limit of the sequence $(K_n^0 \sim)$:

$$K_\infty^0 = \lim_{n \rightarrow \infty} K_n^{0 \sim}$$

This limit is an example of a **proper hyperfinite knot**.

Proposition 4.1 K_∞^0 belongs to $\overline{\mathcal{K}_f} \setminus \mathcal{K}_f$.

Proof: Assume to the contrary an suppose this hyperfinite knot belongs to \mathcal{K}_f . Then there should be a representative of the class with CJKLS invariant equal to $0 + 0 \cdot t$. But, according to Proposition 3.2, at least one of the n_i 's has to be greater than zero. The result follows. \blacksquare

4.5 Infinitely many hyperfinite knots

In this subsection we construct two distinct sequences, the unprimed and the primed sequences of alternating knots, by replacing the $\sigma_i^{\pm 3}$ by $\sigma_i^{\pm 3(2m+1)}$ in the sequences (K_n) and (K'_n) of Subsections 4.2 and 4.3, respectively.

Definition 4.8 (The K_n^m sequence) *Let m be a positive integer. Each term of the sequence (K_n^m) is given by the closure of the corresponding term of the sequence of braids:*

$$\begin{aligned} b_1^m &= \sigma_1^{3(2m+1)}, & \sigma_1 &\in B_1 \\ b_2^m &= \sigma_2^{-3(2m+1)} \cdot \sigma_1^{3(2m+1)} \cdot \sigma_2^{-3(2m+1)}, & \sigma_1, \sigma_2 &\in B_2 \\ b_3^m &= \sigma_3^{3(2m+1)} \cdot \sigma_2^{-3(2m+1)} \cdot \sigma_1^{3(2m+1)} \cdot \sigma_2^{-3(2m+1)} \cdot \sigma_3^{3(2m+1)}, & \sigma_1, \sigma_2, \sigma_3 &\in B_3 \\ & \vdots \end{aligned}$$

$$b_n^m = \sigma_n^{(-1)^{n+1}3(2m+1)} \cdot \dots \cdot \sigma_3^{3(2m+1)} \cdot \sigma_2^{-3(2m+1)} \cdot \sigma_1^{3(2m+1)} \cdot \sigma_2^{-3(2m+1)} \cdot \sigma_3^{3(2m+1)} \cdot \dots \cdot \sigma_n^{(-1)^{n+1}3(2m+1)},$$

$\sigma_1, \dots, \sigma_n \in B_{n+1}$

Definition 4.9 (The K_n^m Sequence) *Let m be a positive integer. Each term of the sequence (K_n^m) is given by the closure of the corresponding term of the sequence of braids:*

$$\begin{aligned} b_1^m &= b_1^m & b_2^m &= b_2^m & b_3^m &= \sigma_3^{3(2m+1)} \sigma_2^{-3(2m+1)} \sigma_1^{3(2m+1)} \sigma_3^{3(2m+1)} \sigma_2^{-3(2m+1)} \sigma_3^{3(2m+1)} \\ b_4^m &= \sigma_4^{-3(2m+1)} \sigma_3^{3(2m+1)} \sigma_2^{-3(2m+1)} \sigma_1^{3(2m+1)} \sigma_3^{3(2m+1)} \sigma_2^{-3(2m+1)} \sigma_3^{3(2m+1)} \sigma_4^{-3(2m+1)} \end{aligned}$$

and in general

$$\begin{aligned} b_{2i+1}^m &= \sigma_{2i+1}^{3(2m+1)} \sigma_{2i}^{-3(2m+1)} \sigma_{2i-1}^{3(2m+1)} \dots \sigma_3^{3(2m+1)} \sigma_2^{-3(2m+1)} \dots \sigma_1^{3(2m+1)} \sigma_3^{3(2m+1)} \dots \\ & \dots \sigma_{2i-1}^{3(2m+1)} \sigma_{2i+1}^{3(2m+1)} \dots \sigma_2^{-3(2m+1)} \sigma_3^{3(2m+1)} \dots \sigma_{2i-1}^{3(2m+1)} \sigma_{2i}^{-3(2m+1)} \sigma_{2i}^{3(2m+1)} \end{aligned}$$

and

$$b_{2i+2}^m = \sigma_{2i+2}^{-3(2m+1)} b_{2i+1}^m \sigma_{2i+2}^{-3(2m+1)}$$

We now merely state the following results. For any positive integers m and n

$$Z(K_n^m) = Z(K_n) = 4^n(1 + 3t)$$

and

$$Z(K_n^m) = Z(K_n) = \begin{cases} 4^{(n+1)/2} \cdot S_{(n+1)/2}^e + t \cdot 4^{(n+1)/2} \cdot S_{(n+1)/2}^o, & \text{for odd } n \\ 4^{n/2+1} \cdot S_{n/2}^e + t \cdot 4^{n/2+1} \cdot S_{n/2}^o, & \text{for even } n \end{cases}$$

The crossing number of K_n^m is

$$c_{K_n^m} = 3(2m+1) \left(\sum_{k=1}^n 2 - 1 \right) = 3(2m+1)(2n-1)$$

and the crossing number of K_n^m is,

$$c_{K_n^m} = \begin{cases} 3(2m+1) \left(\sum_{k=1}^n 2 - 1 \right) + 3(2m+1) \left(\frac{n+1}{2} - 1 \right), & \text{for odd } n \\ 3(2m+1) \left(\sum_{k=1}^n 2 - 1 \right) + 3(2m+1) \left(\frac{n}{2} - 1 \right), & \text{for even } n \end{cases}$$

$$= \begin{cases} \frac{15n-9}{2}(2m+1), & \text{for odd } n \\ \frac{15n-12}{2}(2m+1), & \text{for even } n \end{cases}$$

then

$$f(K_n^m) = \left(\frac{\ln(4^n)}{3(2m+1)(2n-1)}, \frac{\ln(4^n \cdot 3)}{3(2m+1)(2n-1)} \right) = \left(\frac{2n \ln(2)}{3(2m+1)(2n-1)}, \frac{2n \ln(2) + \ln(3)}{3(2m+1)(2n-1)} \right)$$

with

$$\lim_{n \rightarrow \infty} f(K_n^m) = \left(\frac{\ln(2)}{3(2m+1)}, \frac{\ln(2)}{3(2m+1)} \right)$$

So, for each m , there exists,

$$K_\infty^m = \lim_{n \rightarrow \infty} K_n^{m \sim}$$

which yields an infinite collection of distinct hyperfinite knots.

Also,

$$f(K_n'^m) = \begin{cases} \left(\frac{\ln(4^{(n+1)/2} \cdot S_{(n+1)/2}^e)}{\frac{(15n-9)(2m+1)}{2}}, \frac{\ln(4^{(n+1)/2} \cdot S_{(n+1)/2}^o)}{\frac{(15n-9)(2m+1)}{2}} \right), & \text{for odd } n \\ \left(\frac{\ln(4^{n/2+1} \cdot S_{n/2}^e)}{\frac{(15n-12)(2m+1)}{2}}, \frac{\ln(4^{n/2+1} \cdot S_{n/2}^o)}{\frac{(15n-12)(2m+1)}{2}} \right), & \text{for even } n \end{cases}$$

Arguing as in Subsection 4.3 using Claim 4.1 we see that, for each m , there is a convergent subsequence of $(f(K_n'^m))$ which we denote again, $(f(K_n'^m))$. Moreover the limit, $fK_\infty'^m$, of $(f(K_n'^m))$ is different from either $(0, 0)$ or $\left(\frac{\ln(2)}{3(2m+1)}, \frac{\ln(2)}{3(2m+1)} \right)$. So, for each m , there is a limit

$$K_\infty'^m = \lim_{n \rightarrow \infty} K_n'^{m \sim}$$

which is neither K_∞^0 nor K_∞^m .

5 Directions for further research

In this article we formalize the notion of *hyperfinite knot*. We only consider here *hyperfinite knots* that come from the CJKLS invariant with the indicated labelling quandle, abelian group and 2-cocycle. We would like also to use other data for the CJKLS invariant and from them construct other *hyperfinite knots*. How do *hyperfinite knots* relate for different choices of the data for the CJKLS invariant? In particular, if a given sequence of alternating knots with increasing crossing number converges for a given choice of X , A , and ϕ , will it also converge for a different choice of X , A , and ϕ ?

Another direction of research would be to look for a different way of obtaining the f invariant. For instance, could we divide by the determinant of the knot instead of by its crossing number at the appropriate step? Or, altogether, find other f 's that do not come from the CJKLS invariant?

Finally, it would be interesting to list the different hyperfinite knots.

We plan to address these and other questions in future work.

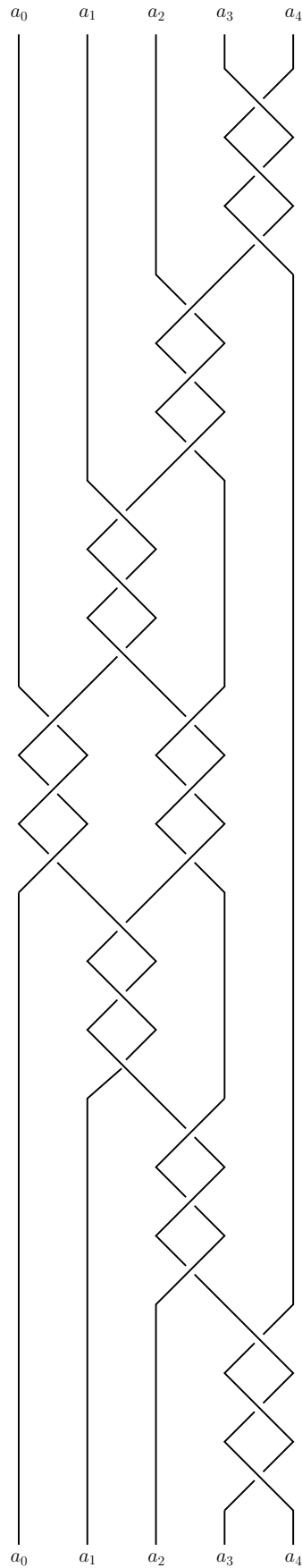

Figure 11: K'_4 , upon closure of the braid, endowed with a coloring by S_4

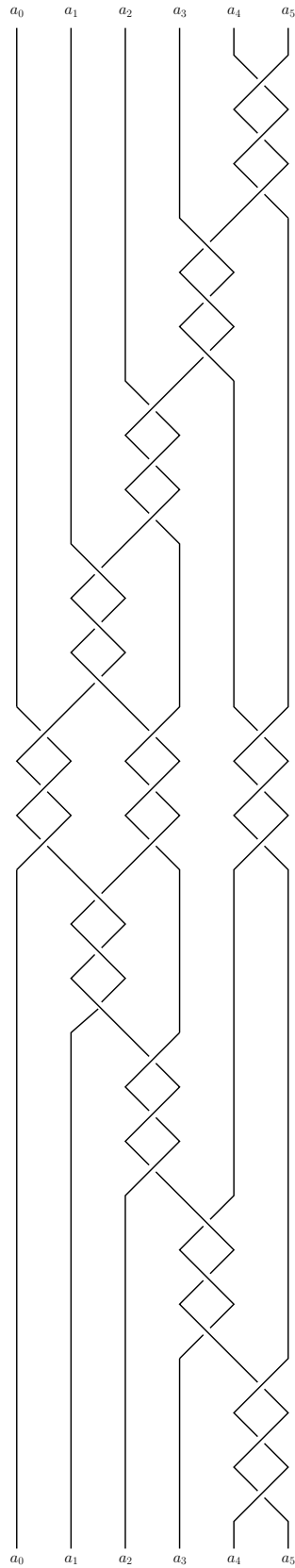

Figure 12: K'_5 , upon closure of the braid, endowed with a coloring by S_4

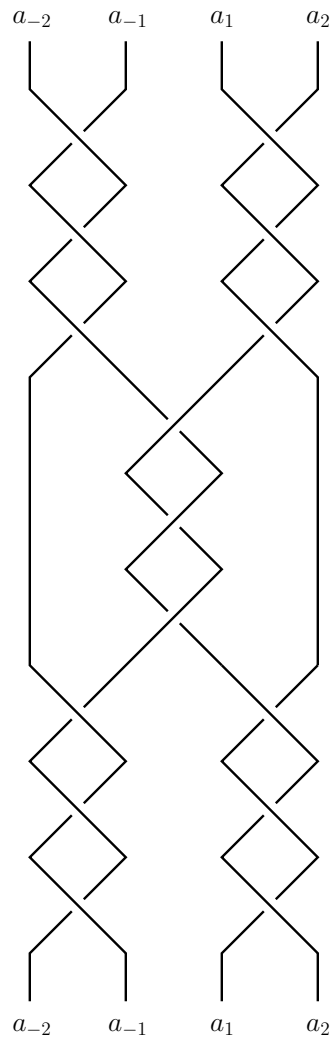

Figure 13: K_2^0 , upon closure of the braid, endowed with a coloring by S_4

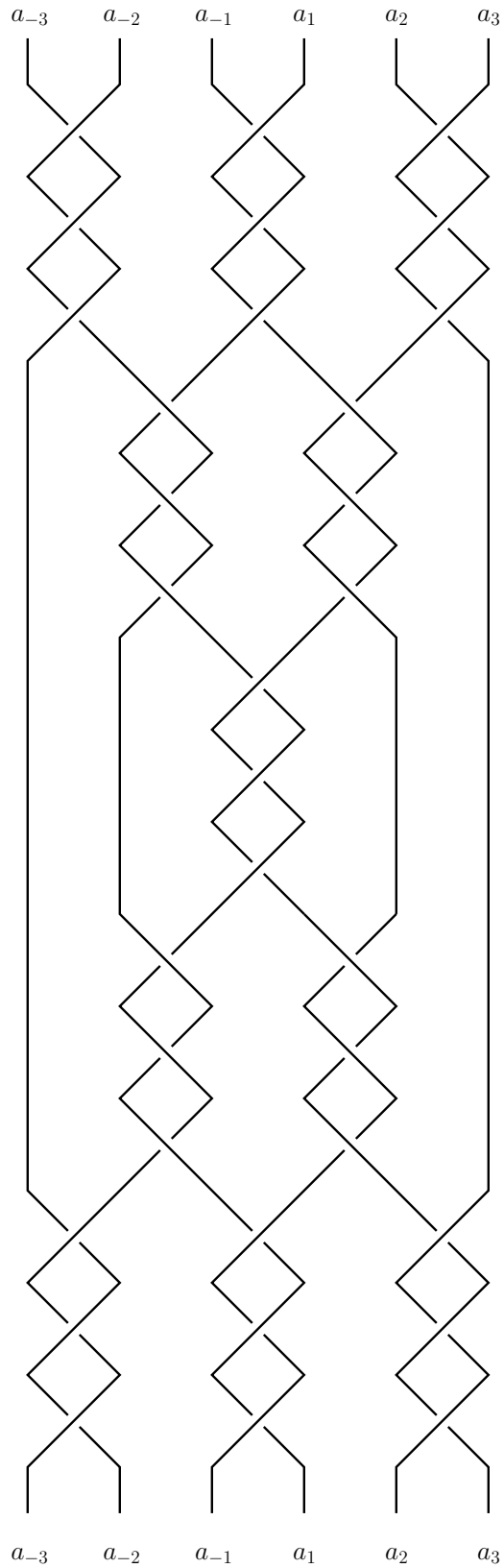

Figure 14: K_3^0 , upon closure of the braid, endowed with a coloring by S_4

References

- [1] Y. Akutsu, M. Wadati, *Knot invariants and the critical statistical systems*, J. Phys. Soc. Japan, **56** (1987), no. 3, 839-842.
- [2] R. J. Baxter, *Exactly solved models in statistical mechanics*, Academic Press, New York (1982)
- [3] J. Birman, *Braids, links, and mapping class groups*, Annals of Math. Studies **82**, Princeton University Press, Princeton, N. J. (1974)
- [4] H. B. Callen, *Thermodynamics and an introduction to thermostatistics*, 2nd edition, John Wiley and Sons, New York (1985)
- [5] J. S. Carter, D. Jelsovsky, S. Kamada, M. Saito, *Computations of quandle cocycle invariants of knotted curves and surfaces*, Adv. Math., **157** (2001), 36-94
- [6] J. S. Carter, D. Jelsovsky, S. Kamada, L. Langford, M. Saito, *Quandle cohomology and state-sum invariants of knotted curves and surfaces*, Trans. Amer. Math. Soc., **355** (2003), no. 10, 3947- 3989
- [7] F. M. Dionísio, P. Lopes, *Quandles at finite temperatures II*, J. Knot Theory Ramifications, **12** (2003), no. 2, 1041-1092
- [8] D. Joyce, *A classifying invariant of knots, the knot quandle*, J. Pure Appl. Alg., **23** (1982), 37-65
- [9] L. H. Kauffman, *Knots and physics*, 3rd edition, Series on Knots and Everything **1**, World Scientific Publishing Co., River Edge, NJ (2001)
- [10] L. H. Kauffman, *Weaving patterns and polynomials*, in “Topology Symposium”, Siegen 1979 (Proc. Sympos. Univ. Siegen, Siegen, 1979, U. Koschorke, W. D. Neumann, eds.), 88-97, Lecture Notes in Math., **788**, Springer Verlag, Berlin, 1980
- [11] L. H. Kauffman, *State models and the Jones polynomial*, Topology, **26** (1987), no. 3, 395-407
- [12] P. Lopes, *Quandles at finite temperatures I*, J. Knot Theory Ramifications, **12** (2003), no. 2, 159-186
- [13] S. V. Matveev, *Distributive groupoids in knot theory*, Math. USSR Sbornik, **47** (1984), no. 1, 73-83
- [14] K. Murasugi, *Jones polynomials and classical conjectures in knot theory*, Topology, **26** (1987), no. 2, 187-194
- [15] M. B. Thistlethwaite, *A spanning tree expansion of the Jones polynomial*, Topology, **26** (1987), no. 3, 297-309
- [16] M. Wadati, T. Deguchi, Y. Akutsu, *Exactly solvable models and knot theory*, Phys. Rep. , **180** (1989), no. 4-5, 247-332