

EQUALITY OF SCHUR'S Q-FUNCTIONS AND THEIR SKEW ANALOGUES

HADI SALMASIAN

ABSTRACT. We find a simple criterion for the equality $Q_\lambda = Q_{\mu/\nu}$ where Q_λ and $Q_{\mu/\nu}$ are Schur's Q-functions on infinitely many variables.

1. INTRODUCTION

Schur's Q-functions are very interesting analogues of the (standard) Schur functions s_λ in several combinatorial and representation-theoretic contexts. Examples of their analogy include the shifted RSK correspondence, the shifted Littlewood-Richardson rule, and the character theory of representations of queer Lie superalgebras. In this note we study when certain shifted Littlewood-Richardson coefficients (the $f_{\mu,\nu}^\lambda$ in the language of [St1]) are zero or one. Studying questions of the same nature has been of interest to a number of authors. In particular, one should mention Stembridge's recent classification of multiplicity-free products of Schur functions [St2] which was generalized to P-functions in [Bes]. The related questions as to when two ribbon Schur functions are equal and when a Schur function is equal to a skew Schur function were answered in [BTW] and [Wi]. Here we show that the latter problem has a simple answer for Schur's Q-functions as well.

This note is organized as follows. In the next section we give all the required definitions. In the third section we prove our main result.

Acknowledgement. The author thanks the referee for reading the paper very carefully.

2. SCHUR'S Q-FUNCTIONS AND SHIFTED TABLEAUX

Our notation is compatible with Stembridge's paper [St1]. A strictly decreasing sequence $\lambda = \{\lambda_1 > \dots > \lambda_k\}$ of positive integers is called a *distinct partition* of n if the sum of the λ_i 's is equal to n . The λ_i 's are called the *parts* of λ . A partition is represented by a shifted Young diagram as follows: there are λ_i boxes in the i -th row, after $i - 1$ empty positions. We denote this diagram by D_λ .

Example 1. Let $\lambda = \{7 > 4 > 2 > 1\}$. Then the diagram D_λ which represents λ is given below.

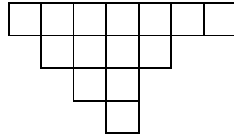

Consider an ordered alphabet

$$\mathcal{A} = \{\bar{1} < 1 < \bar{2} < 2 < \bar{3} < 3 < \dots\}.$$

The letters $\bar{1}, \bar{2}, \dots$ will be referred to as *marked*, whereas the letters $1, 2, \dots$ will be referred to as *unmarked*.

Definition 1. By a *generalized shifted Young tableau (GSYT)* of shape D_λ we mean a filling of a given Young diagram D_λ with letters from \mathcal{A} such that the following properties hold:

- The rows and columns are weakly increasing.

Date: February 1, 2006.

1991 Mathematics Subject Classification. 05E05, 05E10.

Key words and phrases. Schur Q-function, skew Schur Q-function, generalized shifted Young tableaux.

- Each row contains each marked letter at most once.
- Each column contains each unmarked letter at most once.

Let T be a given GSYT. We define x^T to be the monomial $x_1^{a_1}x_2^{a_2}\cdots$ where a_s is the total number of occurrences of s or \bar{s} in T . Schur's Q-function Q_λ is equal to

$$(1) \quad \sum_T x^T$$

where the sum is over all GSYT of shape D_λ . The sequence a_1, a_2, \dots is called the *content* of T .

Now suppose λ and μ are two distinct partitions. Assume that for each i , $\lambda_i \geq \mu_i$, so that D_μ lies inside D_λ . The *shifted skew diagram* associated to λ/μ is the set-theoretic difference of D_λ and D_μ . It is represented by $D_{\lambda/\mu}$.

Example 2. Let λ be as in Example 1 and let $\mu = \{4 > 2\}$. Then $D_{\lambda/\mu}$ is represented by the following skew Young diagram:

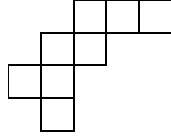

We may assume that $D_{\lambda/\mu}$ is placed on the Cartesian plane in the usual way such that the centers of boxes lie on the lattice of points with integer coordinates. Let $\mathbb{B}_{x,y}$ denote the box whose center is at the point with coordinates (x, y) . The following easy lemma includes some basic properties of shifted skew diagrams.

Lemma 2. Let $D_{\lambda/\mu}$ be an arbitrary shifted skew diagram on the Cartesian plane. For any integer y define

$$R_y = \{\mathbb{B}_{x,y} | \mathbb{B}_{x,y} \in D_{\lambda/\mu}\}.$$

- If $\mathbb{B}_{u,v} \in D_{\lambda/\mu}$ and $R_{v+1} \neq \emptyset$ then there exists an integer $t \geq u$ such that $\mathbb{B}_{t,v+1} \in R_{v+1}$.
- For a fixed v such that $R_v \neq \emptyset$, let u be the smallest number for which $\mathbb{B}_{u,v} \in R_v$. Assume $\mathbb{B}_{u-1,v+1} \in D_{\lambda/\mu}$. Then for any $v' \leq v+1$ such that $R_{v'} \neq \emptyset$, the following statement is true:
 - ◊ $\mathbb{B}_{u+v-v',v'} \in R_{v'}$ and for any s if $\mathbb{B}_{s,v'} \in R_{v'}$ then $s \geq u+v-v'$.

Schur's skew Q-function $Q_{\lambda/\mu}$ is equal to a summation similar to (1), where the summation is now on all shifted skew tableaux T , with underlying diagram $D_{\lambda/\mu}$ filled by the alphabet \mathcal{A} , such that they satisfy the properties of Definition 1. The function $Q_{\lambda/\mu}$ can be expressed as a linear combination of the functions Q_ν for various ν as follows. We have

$$(2) \quad Q_{\lambda/\mu} = \sum_\nu f_{\mu\nu}^\lambda Q_\nu$$

where the summation is over all distinct partitions ν . Here $f_{\mu\nu}^\lambda$ is the number of *amenable* tableaux of shape $D_{\lambda/\mu}$ and content ν . We define the amenable tableaux in Definition 3 below. However, before doing so, we need some notation. For a given (possibly skew) GSYT such as T , the row word of T is the word obtained by reading the rows of T consecutively from left to right starting with the bottom row. We denote the row word of T by $w(T)$. Now, let $w = w_1 \cdots w_n$ be an arbitrary word of length n such that for any s we have $w_s \in \mathcal{A}$. Define a function $m_i(j)$ as follows.

$$m_i(j) = \begin{cases} \text{number of times } i \text{ appears} & \text{if } 1 \leq j \leq n \\ \text{among } w_{n-j+1}, \dots, w_n & \\ \\ m_i(n) + \text{number of times } \bar{i} \text{ appears} & \text{if } n+1 \leq j \leq 2n \\ \text{among } w_1, \dots, w_{j-n} & \end{cases}$$

By convention, we assume $m_i(0) = 0$ for any $i > 0$.

Definition 3. Let $k > 1$ be an integer. A word $w = w_1 \cdots w_n$ is called *k-amenable* iff it satisfies the following properties:

- For any $j \in \{0, \dots, n-1\}$ if $m_k(j) = m_{k-1}(j)$ then $w_{n-j} \notin \{k, \bar{k}\}$.
- For any $j \in \{n, \dots, 2n-1\}$, if $m_k(j) = m_{k-1}(j)$ then $w_{j-n+1} \notin \{\bar{k}, k-1\}$.
- If j is the smallest number such that $w_j \in \{k, \bar{k}\}$, then $w_j = k$.
- If j is the smallest number such that $w_j \in \{k-1, \bar{k}-1\}$, then $w_j = k-1$.

A word w is called amenable if it is k -amenable for any $k > 1$.

Remark. Suppose $w = w_1 \cdots w_n$ is k -amenable for some $k > 1$. Then it follows from Definition 3 that if $m_{k-1}(2n) > 0$ then $m_k(2n) < m_{k-1}(2n)$. (To prove this, first we show that Definition 3 implies $m_{k-1}(j) \geq m_k(j)$ for any $j \in \{1, \dots, 2n\}$. Then we pick the largest j such that $w_j \in \{k, \bar{k}\}$, and we show that Definition 3 implies that there must exist a $j_1 > j$ such that $w_{j_1} = \bar{k}-1$. The details of the argument are left to the reader.) Consequently, if $w = w_1 \cdots w_n$ is amenable, then

$$m_1(2n) \geq m_2(2n) \geq m_3(2n) \geq \cdots$$

Definition 4. A given GSYT is called amenable iff its row word is amenable.

3. THE MAIN RESULT

In this section we prove the main statement of this note.

Definition 5. A shifted skew diagram $D_{\lambda/\mu}$ is called strange iff $Q_{\lambda/\mu} = Q_\nu$ for some distinct partition ν .

Theorem 6. $D_{\lambda/\mu}$ is a strange diagram if and only if $\lambda/\mu = \bar{\lambda}/\bar{\mu}$ where

- $\bar{\lambda}$ is arbitrary and $\bar{\mu} = \{\}$.
- $\bar{\lambda} = \{m > m-1 > \cdots > 1\}$ and $\bar{\mu} = \{\mu_1 > \cdots > \mu_l\}$ where $0 < l < m-1$.
- $\bar{\lambda} = \{p+q+r > p+q+r-1 > p+q+r-2 > \cdots > p\}$ and $\bar{\mu} = \{q > q-1 > \cdots > 1\}$ where p, q, r are integers such that $p, q \geq 1, r \geq 0$.
- $\bar{\lambda} = \{p+q > p+q-1 > \cdots > p+q-r\}$ and $\bar{\mu} = \{q > q-1 > \cdots > q-r\}$ where p, q, r are integers such that $p > 0$ and $q > r \geq 0$.

Remark. The reader should note that there are overlaps among the cases for special values of p, q, r . Moreover, whether or not $D_{\lambda/\mu}$ is strange only depends on λ/μ and not on λ and μ individually. Theorem 6 identifies $D_{\lambda/\mu}$ by identifying all possible differences λ/μ , but not all possibilities of λ and μ . The latter problem is not hard once we have Theorem 6.

The proof of Theorem 6 will be given throughout this section. From equation (2) it follows that $D_{\lambda/\mu}$ is strange if and only if there exists a unique amenable filling of $D_{\lambda/\mu}$. Our approach is to rule out various possibilities for the shape of $D_{\lambda/\mu}$ by demonstrating the existence of at least two different amenable fillings in each case.

3.1. An algorithm for finding an amenable filling. We give a simple algorithm to construct an amenable tableau of any given shape $D_{\lambda/\mu}$. The output of the algorithm is an amenable tableau of content ν for some distinct partition ν . Note that ν is generated by the algorithm and is not an input.

Notation. Let $\mathbb{B}_{x,y}$ be a box in a diagram. The operation of filling (or replacing the current entry of) $\mathbb{B}_{x,y}$ by the letter $w \in \mathcal{A}$ is represented by $\mathbb{B}_{x,y} \leftarrow w$. The operation of filling (or replacing the entry of) $\mathbb{B}_{x,y}$ by the current entry of $\mathbb{B}_{x',y'}$ is represented by $\mathbb{B}_{x,y} \leftarrow \mathbb{B}_{x',y'}$.

The algorithm is given below.

Step 1. Set $k = 1$ and $D_{\lambda/\mu}^{(1)} = D_{\lambda/\mu}$.

Step 2. Set $P_k = \{\mathbb{B}_{x,y} \mid \mathbb{B}_{x,y} \in D_{\lambda/\mu}^{(k)} \text{ but } \mathbb{B}_{x-1,y+1} \notin D_{\lambda/\mu}^{(k)}\}$.

Step 3. Put a k or a \bar{k} in any of the boxes in P_k according to the following rule:

$$\begin{cases} \mathbb{B}_{x,y} \leftarrow k & \text{if } \mathbb{B}_{x,y-1} \notin P_k \\ \mathbb{B}_{x,y} \leftarrow \bar{k} & \text{if } \mathbb{B}_{x,y-1} \in P_k \end{cases}$$

Step 4. Remove all boxes of P_k from $D_{\lambda/\mu}^{(k)}$. Let $D_{\lambda/\mu}^{(k+1)}$ be the diagram obtained after removing boxes. If $D_{\lambda/\mu}^{(k+1)}$ has no boxes, then stop.

Step 5. Increase k by one. Go back to Step 2.

Let k be a positive integer. Then each connected component of P_k forms a ‘‘path’’ of boxes in a connected component of the diagram $D_{\lambda/\mu}^{(k)}$. (A connected component of $D_{\lambda/\mu}^{(k)}$ (or P_k) is a maximal subset of boxes of $D_{\lambda/\mu}^{(k)}$ (or P_k) which can be ordered in a sequence so that each box has a common edge with at least one of the boxes preceding it in the sequence.) Each of these paths can be directed as follows. Let Q be a connected component of P_k . We know that Q is a path of boxes. The first box of this path is the box $\mathbb{B}_{x,y} \in Q$ such that $\mathbb{B}_{x,y+1} \notin Q$ and $\mathbb{B}_{x+1,y} \notin Q$. The last box of Q is the box $\mathbb{B}_{x,y} \in Q$ such that $\mathbb{B}_{x-1,y} \notin Q$ and $\mathbb{B}_{x,y-1} \notin Q$.

Example 3. The first and last boxes of the following path are marked with a dot and a cross respectively. It is traversed from the dotted box to the crossed one.

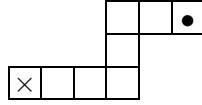

Lemma 7. For any $k > 1$, $P_k = \{\mathbb{B}_{x,y} | \mathbb{B}_{x,y} \in D_{\lambda/\mu} \text{ and } \mathbb{B}_{x-1,y+1} \in P_{k-1}\}$.

Example 4. Let $\lambda = \{7 > 5 > 3 > 2 > 1\}$ and $\mu = \{4 > 1\}$. Then the algorithm provides the following amenable filling.

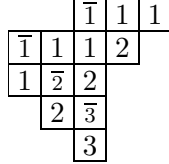

Lemma 8. Let $k > 1$ and $\mathbb{B}_{x,y} \in P_k$. Then

- $\mathbb{B}_{x,y+1} \in D_{\lambda/\mu}$ and $\mathbb{B}_{x,y+1} \in P_k \cup P_{k-1}$.
- If $\mathbb{B}_{x,y+1} \in P_{k-1}$ then $\mathbb{B}_{x-1,y+1} \in P_{k-1}$ as well.

Proof. Left to the reader! □

The following lemma is a very simple but useful criterion of amenability. Its proof is left to the reader.

Lemma 9. Let T be a GSYT of shape $D_{\lambda/\mu}$ and let $w = w(T)$ be the row word of T . For any integer $k > 1$, form the word $w^{(k)}$ from w by dropping all the letters in w which are not in $\{k, \bar{k}, k-1, \overline{k-1}\}$. (For example, if $w = 2\bar{2}3\bar{2}211\bar{2}\bar{1}11$ then $w^{(3)} = 2\bar{2}3\bar{2}2\bar{2}$.) Then w is amenable if and only if $w^{(k)}$ is either k -amenable or empty for any $k > 1$.

Lemma 10. The filling of the boxes obtained by the previous algorithm is amenable.

Proof. Properties of Definition 1 are satisfied trivially. It remains to show that this filling is amenable. By Lemma 9 it suffices to check k -amenability of $w(T)^{(k)}$ for any k . It is easily seen that if $D_{\lambda/\mu}$ is disconnected but each connected component of T is amenable, then T is amenable too. Therefore we can assume $D_{\lambda/\mu}$ is connected. Next we show that $w(T)^{(2)}$ is amenable. The argument in the general case is similar. Let the length of $w(T)^{(2)}$ be n . Amenability of $w(T)^{(2)}$ follows from the following facts:

- For any box filled by a 2, there is a box above it in the same column which is filled by a 1. This implies that $m_1(j) \geq m_2(j)$ for any $j \leq n$.

- Since the last entry of the path P_1 is filled by a 1 and there is no 2 below it, we have $m_1(n) > m_2(n)$.
- There is exactly one $\bar{1}$ in every row of $D_{\lambda/\mu}$ in which P_1 has boxes, except for the lowest row among them. The same statement holds for P_2 and $\bar{2}$.
- Set $X_i = \{y \mid \text{for some } x, \mathbb{B}_{x,y} \in P_i\}$. Then

$$X_1 = \{s \mid s \text{ is an integer and } c_1 \leq s \leq c_2\}$$

for integers $c_1 \geq c_2$. Moreover $X_2 \subseteq \{s - 1 \mid s \in X_1\}$.

□

3.2. Disconnected diagrams. A slight modification of the algorithm of section 3.1 can be applied to show that $D_{\lambda/\mu}$ is not a strange diagram whenever there exist disconnected P_k 's. More accurately, we have the following lemma.

Lemma 11. *Let T be a GSYT obtained by applying the algorithm of section 3.1 to $D_{\lambda/\mu}$. Suppose that for some k , P_k is disconnected. Then $D_{\lambda/\mu}$ has an amenable filling different from the one given by the algorithm.*

Proof. Let $P_k = P^1 \cup \dots \cup P^l$, $l > 1$, where P^i 's are mutually disjoint paths, ordered such that for any i , P^i lies to the northeast of P^{i+1} . Note that the P^i 's belong to mutually disjoint connected components of the diagram $D_{\lambda/\mu}^{(k)}$. Since the filling of P_k is obtained by the algorithm, the last box of P^1 is filled by a k . We claim that if we change it to a \bar{k} , the new filling is still amenable. To this end we use Lemma 9. One can see that changing a k to a \bar{k} does not affect k -amenability of $w(T)^{(k)}$ unless we are changing the last box of P^l . Moreover $w(T)^{(k+1)}$ remains $k+1$ -amenable since $w(T)^{(k+1)}$ can be written as $w(T)^{(k+1)} = w^1 \dots w^l$ where w^i is the row word of the intersection of $P_k \cup P_{k+1}$ with the connected component of $D_{\lambda/\mu}^{(k)}$ which contains P^{l-i+1} . A bookkeeping argument using the facts that the words w^1, \dots, w^{l-1} are $k+1$ -amenable and w^l is "not far from" being $k+1$ -amenable completes the proof. □

From Lemma 11 we conclude that if $D_{\lambda/\mu}$ is a strange diagram then for any k the set P_k which is obtained by the algorithm of section 3.1 is in fact a (connected) path. This fact simplifies the case-by-case analysis of possible shapes of $D_{\lambda/\mu}$. Probably a few remarks are necessary before starting the next section:

•**Amenability arguments.** Throughout the next section, at several points we give procedures to modify an existing filling and claim that the new filling will be amenable too. The proofs of amenability of these new fillings are very similar in nature. However, most of these amenability proofs are not given because they are tedious but very simple. The main ideas are using Lemma 9 and bookkeeping arguments.

•**Figures.** Throughout the next section there are several illustrations which help the reader understand the effect of procedures on the fillings. The figures usually demonstrate a union of P_m, P_{m-1}, \dots, P_r for some r . Only the boxes whose entries change by the procedures are shown. The dots show that there may or may not be boxes in the direction of the dots. See the following example.

Example 5. Let m denote the largest integer such that $P_m \neq \emptyset$. Suppose $m = 7$ and the union $P_6 \cup P_7$ is illustrated by the diagram

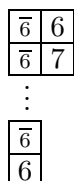

This means that there may or may not be a vertical path of boxes which belong to P_6 in the location of the dots. For instance $P_6 \cup P_7$ may actually be

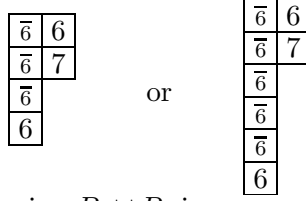

Now again suppose $m = 7$ and the union $P_6 \cup P_7$ is represented by

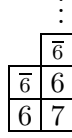

This means that if the path P_6 extends from the top right corner of $P_6 \cup P_7$, then its direction will be vertical in the beginning. (However, its direction does not have to remain vertical all the time.) For instance, $P_6 \cup P_7$ may actually be

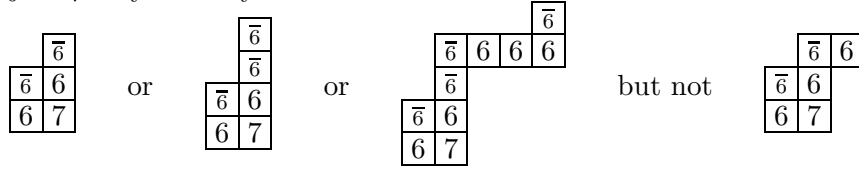

Again let $m = 7$ and suppose $P_6 \cup P_7$ is illustrated by the diagram

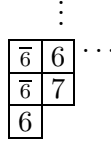

This means that P_6 may extend either horizontally or vertically (but clearly not both, since P_6 is a path).

3.3. A case-by-case examination. Let T be the filling of $D_{\lambda/\mu}$ obtained by the algorithm of section 3.1. By Lemma 11, P_k is a connected path for any k . Let m be the largest integer for which P_m is nonempty. Then the following possibilities exist for P_m :

- P_m consists of a single box.
- P_m lies within a single row and has at least two boxes.
- P_m lies within a single column and has at least two boxes.
- P_m is none of the above.

We will study the first three possibilities in subsequent sections. Here we show that the fourth case is actually impossible when $D_{\lambda/\mu}$ is a strange diagram.

Lemma 12. *Suppose $D_{\lambda/\mu}$ is a strange diagram. Then the boxes of P_m lie within a single row or column.*

Proof. The following figures show how to obtain a new amenable filling of $D_{\lambda/\mu}$ when P_m has a “turning point”. If the path P_m changes its direction at some point clockwise, i.e. if for integers x, y we have $\mathbb{B}_{x,y}, \mathbb{B}_{x,y+1}, \mathbb{B}_{x-1,y} \in P_m$ then all we need to do is

$$\mathbb{B}_{x,y} \leftarrow m + 1 \text{ and } \mathbb{B}_{x,y+1} \leftarrow m.$$

If it changes its direction counterclockwise, i.e. if $\mathbb{B}_{x,y}, \mathbb{B}_{x,y-1}, \mathbb{B}_{x+1,y} \in P_m$, then we should find the smallest y' such that $\mathbb{B}_{x,y'} \in P_m$ and then do $\mathbb{B}_{x,y'} \leftarrow m + 1$ and $\mathbb{B}_{x,y'+1} \leftarrow m$.

Example 6. Suppose $m = 5$. Then P_m and the way it changes are illustrated below.

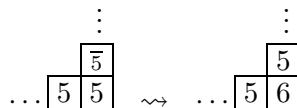

clockwise turn

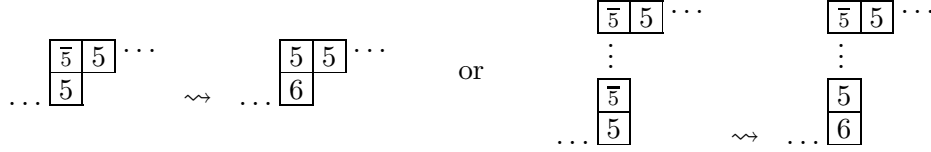

Counterclockwise turn

Checking amenability is easy and left to the reader.

□

In the subsequent sections we address the other possibilities for P_m .

3.4. Case I: P_m consists of one box only. We will assume $D_{\lambda/\mu}$ is a strange diagram and $m > 1$. Let $\mathbb{B}_{x,y}$ be the box in P_m . Then by Lemma 8 and Lemma 7, $\mathbb{B}_{x,y+1}$ contains $m - 1$ and $\mathbb{B}_{x-1,y+1} \in P_{m-1}$. Now we have the following two possibilities:

1. $\mathbb{B}_{x-1,y} \notin D_{\lambda/\mu}$. Then it follows that $\mathbb{B}_{x-1,y+1}$ should be the last box of P_{m-1} , as P_{m-1} cannot proceed to $B_{x-2,y+1}$ by Lemma 2. This in turn yields three new possibilities:
 - Case a.** $\mathbb{B}_{x,y+2}, \mathbb{B}_{x+1,y+1} \notin P_{m-1}$. In this case P_{m-1} has two boxes only.
 - Case b.** $\mathbb{B}_{x,y+2} \in P_{m-1}$.
 - Case c.** $\mathbb{B}_{x+1,y+1} \in P_{m-1}$.
2. $\mathbb{B}_{x-1,y} \in D_{\lambda/\mu}$. Then $\mathbb{B}_{x-1,y+1}$ should be filled by $\overline{m-1}$ and $\mathbb{B}_{x-1,y} \in P_{m-1}$. One of the following six cases may take place.
 - Case d.** $\mathbb{B}_{x-2,y} \in P_{m-1}$.
 - Case e.** $\mathbb{B}_{x-1,y-1}, \mathbb{B}_{x-1,y-2} \in P_{m-1}$.
 - Case f.** $\mathbb{B}_{x-1,y-1} \in P_{m-1}$ but $\mathbb{B}_{x-1,y-2} \notin D_{\lambda/\mu}$.
 - Case g.** $\mathbb{B}_{x-2,y}, \mathbb{B}_{x-1,y-1} \notin P_{m-1}$ but $\mathbb{B}_{x+1,y+1} \in P_{m-1}$.
 - Case h.** $\mathbb{B}_{x-2,y}, \mathbb{B}_{x-1,y-1} \notin P_{m-1}$ but $\mathbb{B}_{x,y+2} \in P_{m-1}$.
 - Case i.** $\mathbb{B}_{x-2,y}, \mathbb{B}_{x-1,y-1}, \mathbb{B}_{x,y+2}, \mathbb{B}_{x+1,y+1} \notin P_{m-1}$.

Assuming $m = 7$ we can illustrate $P_m \cup P_{m-1}$ in cases a to i by the following figures.

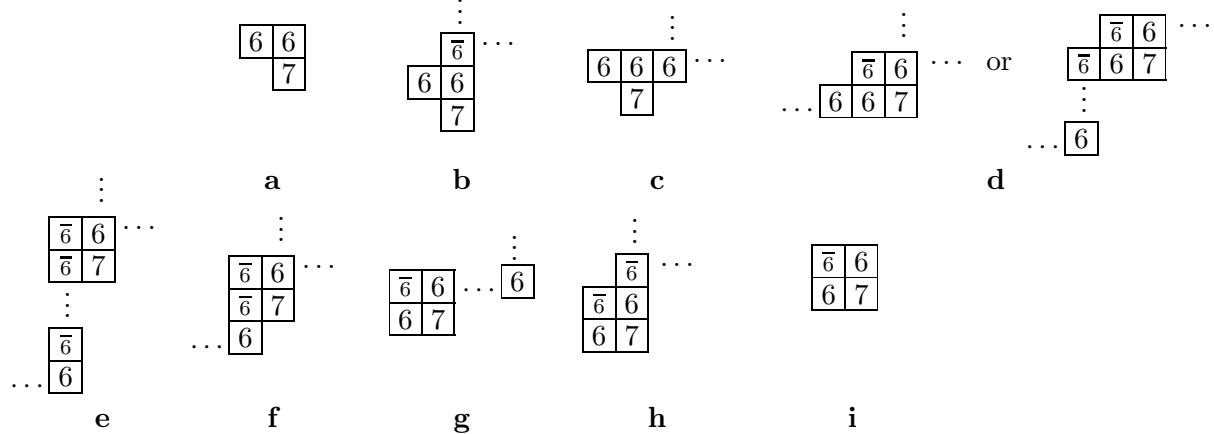

Note that in the cases d,e,f,g and h given above we can modify the filling to get another amenable one as shown in the following figures. Therefore if $P_m \cup P_{m-1}$ is one of those cases then $D_{\lambda/\mu}$ cannot be strange.

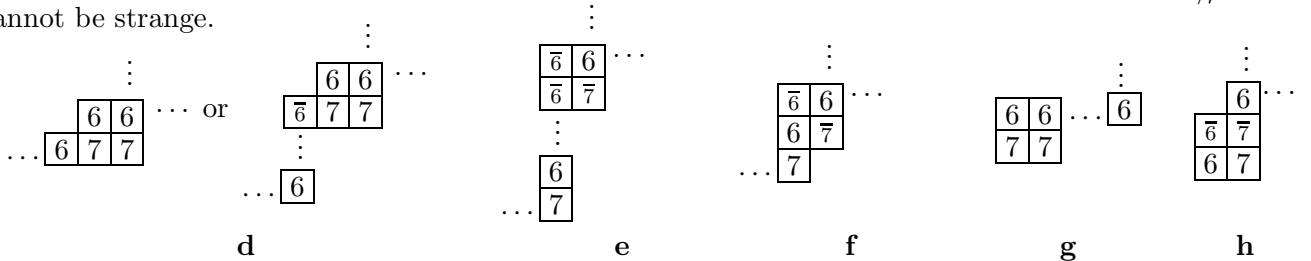

The only remaining possibility is Case i. If $m = 2$ then $D_{\lambda/\mu}$ is equal to the underlying diagram of figure i, and has a unique amenable filling. Assume $m > 2$. Next we prove Proposition 14.

Definition 13. A path of boxes is called a (p, q) -hook if it has p vertical boxes in the first column and q horizontal boxes in the first row.

Example 7. The following figure illustrates a $(2, 3)$ -hook.

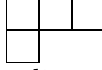

Proposition 14. Suppose $D_{\lambda/\mu}$ is a strange diagram and $P_{m-1} \cup P_m$ is as in Case i. Then for any j , P_j is a $(p_j, m - j + 1)$ -hook for some $p_j \leq m - j + 1$. Moreover, if for some $j > 1$ we have $p_j < m - j + 1$, then $p_j = p_{j-1} = \dots = p_1$.

Proof. We use backwards induction. Assume the statement holds for

$$P_{m-r+1}, \dots, P_m$$

where $r > 1$. We prove it for P_{m-r} . Suppose that P_{m-r+1} is an (l, r) -hook for some $1 \leq l \leq r$. As before, assume $\mathbb{B}_{x,y} \in P_m$. Lemma 11, Lemma 7 and Lemma 2 imply that

◇ For any j such that $1 \leq j \leq l - 1$, we have $\mathbb{B}_{x-r, y+r-j} \in P_{m-r}$ and

◇ For any j such that $0 \leq j \leq r$, we have $\mathbb{B}_{x-j, y+r} \in P_{m-r}$.

Let Q denote the path formed by the boxes in the two statements given above. Obviously $Q \subseteq P_{m-r}$. We have the following two cases:

Case A. $l < r$. Then $\mathbb{B}_{x-r, y+r+1-l}$ should be the last box of P_{m-r} . We will show that $P_{m-r} = Q$. Suppose, on the contrary, that $P_{m-r} \neq Q$. Then either $\mathbb{B}_{x, y+r+1} \in P_{m-r}$ or $\mathbb{B}_{x+1, y+r} \in P_{m-r}$. However, $D_{\lambda/\mu}$ cannot be strange in either of the cases, as shown below.

Case A1. $\mathbb{B}_{x+1, y+r} \in P_{m-r}$. Let $u = x - r, v = y + r + 1 - l$. Then the following procedure provides a new filling.

Step 1. Set $t = 1$ and $\mathbb{B}_{u, v+1} \leftarrow m - r$.

Step 2. If $\mathbb{B}_{u+t-1, v-t+1} \notin D_{\lambda/\mu}$ then stop.

Step 3. Find smallest $y' \geq v - t$ such that $\mathbb{B}_{u+t, y'} \in D_{\lambda/\mu}$. If there is no such y' , then stop.

Step 4. If $\mathbb{B}_{u+t, y'} \in P_s$ then do $\mathbb{B}_{u+t-1, v-t+1} \leftarrow s$ and $\mathbb{B}_{u+t, v-t+1} \leftarrow s$.

Step 5. Increase t by one. Go back to Step 2.

The idea behind the procedure can be more concretely described as follows. We eliminate the last box of P_{m-r} , add this box to $D_{\lambda/\mu}^{(m-r+1)}$, and find new paths P_{m-r+1}, \dots, P_m according to the algorithm of section 3.1.

The following figure demonstrates the above procedure when $m = 8$ and $r = 3$.

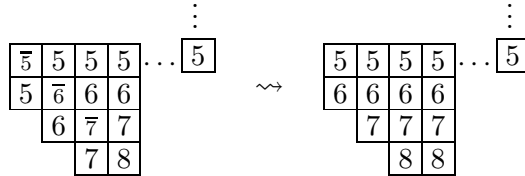

Case A2. $\mathbb{B}_{x, y+r+1} \in P_{m-r}$. Then the following procedure gives the new amenable filling.

Step 1. Set $t = r + 1$.

Step 2. If $t > 1$ then replace the entry of $\mathbb{B}_{x, y+t}$ by that of $\mathbb{B}_{x, y+t-1}$. If $t = 1$ then replace the entry of $\mathbb{B}_{x, y+t}$ by \overline{m} . If $t < 1$ then stop.

Step 3. Decrease t by one. Go back to Step 2.

The amenability of the diagram obtained by the procedure follows from statements similar to those that appear in the proof of Lemma 10.

For $m = 7$ and $r = 2$ the following figure demonstrates the effect of the procedure.

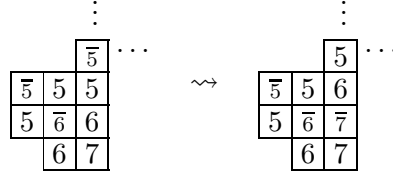

Case B. $l = r$. In this case if $\mathbb{B}_{x-r,y} \notin P_{m-r}$ then we can argue as in the case $l < r$ to show that $P_{m-r} = Q$. The following figure illustrates what happens when $m = 7$, $r = 2$ and $\mathbb{B}_{x+1,y+r} \in P_{m-r}$.

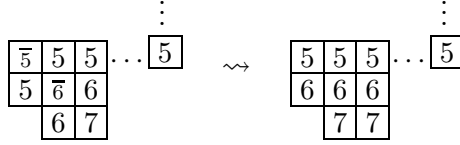

Therefore we may assume $\mathbb{B}_{x-r,y} \in P_{m-r}$. Next we show that

$$P_{m-r} = Q \cup \{\mathbb{B}_{x-r,y}\}.$$

Suppose on the contrary that $P_{m-r} \neq Q \cup \{\mathbb{B}_{x-r,y}\}$. Then one of the following cases occurs. In all of them we show that $D_{\lambda/\mu}$ is not strange.

- Case B1.** $\mathbb{B}_{x-r-1,y} \in P_{m-r}$. We can get a new amenable filling by the operations $\mathbb{B}_{x-r,y} \leftarrow m-r+1$ and $\mathbb{B}_{x-r,y+1} \leftarrow m-r$.
- Case B2.** $\mathbb{B}_{x-r,y-1} \in P_{m-r}$. In this case we can obtain a new amenable filling as follows. Find the smallest y' such that $\mathbb{B}_{x-r,y'} \in P_{m-r}$. Then do $\mathbb{B}_{x-r,y'+1} \leftarrow m-r$, $\mathbb{B}_{x-r,y'} \leftarrow m$ and $\mathbb{B}_{x,y} \leftarrow \bar{m}$.
- Case B3.** $\mathbb{B}_{x-r-1,y} \notin P_{m-r}$, $\mathbb{B}_{x-r,y-1} \notin P_{m-r}$ but $\mathbb{B}_{x+1,y+r} \in P_{m-r}$. The new amenable filling is obtained by

$$\mathbb{B}_{x-r,y} \leftarrow m-r+1 \text{ and } \mathbb{B}_{x-r,y+1} \leftarrow m-r.$$

The following figure illustrates this procedure when $m = 7$, $r = 4$.

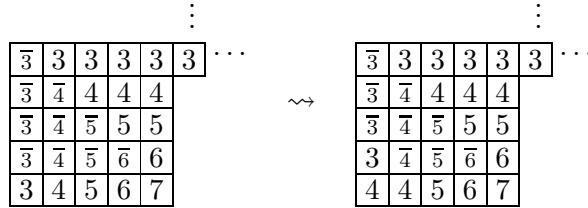

- Case B4.** $\mathbb{B}_{x-r-1,y} \notin P_{m-r}$, $\mathbb{B}_{x-r,y-1} \notin P_{m-r}$ but $\mathbb{B}_{x,y+r+1} \in P_{m-r}$. In this case exactly the same procedure that was given in the analysis of Case A2 can provide a new filling. We illustrate it below with $m = 7$ and $r = 4$.

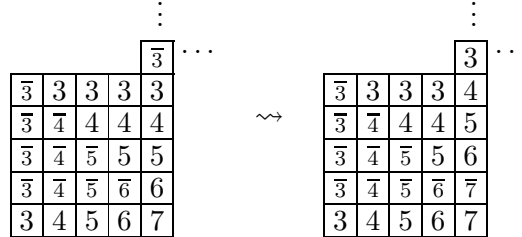

□

Remark. The proof of Proposition 14 actually proves more. It proves the following corollary.

Corollary 15. Let $D_{\lambda/\mu}$ be a strange diagram and $P_m \cup P_{m-1}$ be as in Case i . Then $\lambda/\mu = \bar{\lambda}/\bar{\mu}$ such that

- $\bar{\lambda} = \{p+q+r > p+q+r-1 > p+q+r-2 > \cdots > p\}$ and $\bar{\mu} = \{q > q-1 > \cdots > 1\}$ where p, q, r are integers such that $p, q \geq 1$, $r \geq 0$.
- $\bar{\lambda} = \{p+q > p+q-1 > \cdots > p+q-r\}$ and $\bar{\mu} = \{q > q-1 > \cdots > q-r\}$ where p, q, r are integers such that $p > 0$ and $q > r \geq 0$.

- Step 1.** Set $t = 0$.
Step 2. If $\mathbb{B}_{p,q+t} \in D_{\lambda/\mu}$ then do $\mathbb{B}_{p,q+t+1} \leftarrow \mathbb{B}_{p,q+t}$. Otherwise, do $\mathbb{B}_{p,q+t+1} \leftarrow r_1 - t$ and stop.
Step 3. Decrease t by one. Go back to Step 2.

The idea of the procedure is similar to that of the procedure given in Case B4 of Proposition 14.

Case C2. $r = r_1$. Then it follows that $r \leq r'$. In this case we use the following procedure.

- Step 1.** Set $t = 1$ and do $\mathbb{B}_{p,q+1} \leftarrow r_1$.
Step 2. If $\mathbb{B}_{p+t,q-t} \in D_{\lambda/\mu}$, then do $\mathbb{B}_{p+t-1,q-t+1} \leftarrow \overline{r_1 + t}$ and $\mathbb{B}_{p+t,q-t+1} \leftarrow r_1 + t$.
Step 3. If $\mathbb{B}_{p+t,q-t} \notin D_{\lambda/\mu}$ and $\mathbb{B}_{p+t-1,q-t} \in D_{\lambda/\mu}$ then do $\mathbb{B}_{p+t-1,q-t+1} \leftarrow \overline{r_1 + t}$ and stop.
Step 4. If $\mathbb{B}_{p+t,q-t}, \mathbb{B}_{p+t-1,q-t} \notin D_{\lambda/\mu}$ then do $\mathbb{B}_{p+t-1,q-t+1} \leftarrow r_1 + t$ and stop.
Step 5. Increase t by one. Go back to Step 2.

The idea behind the procedure is to eliminate one of the boxes of P_{r_1} , modify the filling of P_{r_1} slightly, attach the box removed from P_{r_1} to $D_{\lambda/\mu}^{(r_1+1)}$ and find new paths P_{r_1+1}, \dots, P_m according to the algorithm of section 3.1. □

3.5. Case II: P_m lies within a single row and has at least two boxes. Let us assume that the boxes that belong to P_m are $\mathbb{B}_{x-l,y}, \dots, \mathbb{B}_{x,y}$ where $l > 0$. From Lemma 8 it follows that for any $j \in \{0, \dots, l+1\}$, $\mathbb{B}_{x-j,y+1} \in P_{m-1}$. We have the following two cases.

Case D1. $\mathbb{B}_{x-l-1,y} \in D_{\lambda/\mu}$. In this case the boxes $\mathbb{B}_{x-l-1,y+1}, \dots, \mathbb{B}_{x,y+1}$ and $\mathbb{B}_{x-l-1,y}$ form a path in P_{m-1} . An argument similar to the one given in Case B of Proposition 14 proves that there are no other boxes in P_{m-1} . Next we state the following proposition which is similar in statement and proof to Proposition 14.

Proposition 18. *Suppose that $D_{\lambda/\mu}$ is a strange diagram such that $P_m \cup P_{m-1}$ is as in Case D1. Then for any $j \in \{1, \dots, m\}$, P_j is a $(p_j, l + m - j + 1)$ -hook for some $p_j \leq m - j + 1$. Moreover, if there exists a $j > 1$ such that $p_j < m - j + 1$, then $p_j = p_{j-1} = \dots = p_1$.*

We omit the proof of Proposition 18 because it is very similar to the proof of Proposition 14.

Case D2. $\mathbb{B}_{x-l-1,y} \notin D_{\lambda/\mu}$. The analysis of this case is similar to that of Case a in section 3.4. (See Proposition 17.) In fact we can prove the following proposition.

Proposition 19. *Suppose that $D_{\lambda/\mu}$ is a strange diagram which is as in Case II above, and moreover $\mathbb{B}_{x-l-1,y} \notin D_{\lambda/\mu}$. Then $D_{\lambda/\mu} = D_{\bar{\lambda}}$ for an arbitrary $\bar{\lambda}$.*

Proof. It suffices to show that for any j , P_j lies within a single row. The proof is by contradiction. Assume the contrary, and let j be the largest integer such that P_j does not lie within one row. From Lemma 8 it follows that if p' is the largest integer for which there exists a box $\mathbb{B}_{p',y+m-j-1} \in P_{j+1}$ then there exists a $p \geq p'$ such that $\mathbb{B}_{p,q}, \mathbb{B}_{p-1,q}, \mathbb{B}_{p,q+1} \in P_j$, where $q = y + m - j$. Now set $r_1 = j$ and apply the procedure given in Case C1 of the proof of Proposition 17 to get a new amenable filling. □

Corollary 20. *Let $D_{\lambda/\mu}$ be as in Case II. Suppose $D_{\lambda/\mu}$ is a strange diagram. Then either $D_{\lambda/\mu} = D_{\bar{\lambda}}$ for an arbitrary $\bar{\lambda}$, or $D_{\lambda/\mu}$ is given as in the statement of Corollary 15.*

3.6. Case III: P_m lies within a single column and has at least two boxes. The analysis in this case is pretty similar to the previous cases. Suppose P_m consists of the boxes $\mathbb{B}_{x,y+l}, \dots, \mathbb{B}_{x,y}$ where $l > 0$. Then for any $j \in \{1, \dots, l+1\}$, $\mathbb{B}_{x-1,y+j} \in P_{m-1}$. Moreover, $\mathbb{B}_{x,y+l+1} \in P_{m-1}$. Next we show that none of the boxes $\mathbb{B}_{x+1,y+l+1}, \mathbb{B}_{x-1,y-1}, \mathbb{B}_{x-2,y}$ can belong to P_{m-1} . In fact in each of the following cases we show that $D_{\lambda/\mu}$ cannot be a strange diagram.

- $\mathbb{B}_{x-1,y-1} \in P_{m-1}$. Then we get a new filling as follows. Find the smallest y' such that $\mathbb{B}_{x-1,y'} \in P_{m-1}$ and do

$$\mathbb{B}_{x-1,y'+1} \leftarrow m-1, \mathbb{B}_{x-1,y'} \leftarrow m \text{ and } \mathbb{B}_{x,y} \leftarrow \bar{m}.$$

- $\mathbb{B}_{x-2,y} \in P_{m-1}$. Then we obtain a new filling by

$$\mathbb{B}_{x-1,y} \leftarrow m \text{ and } \mathbb{B}_{x-1,y+1} \leftarrow m-1.$$
- $\mathbb{B}_{x-1,y-1}, \mathbb{B}_{x-2,y} \notin P_{m-1}$ but $\mathbb{B}_{x+1,y+l+1} \in P_{m-1}$. Then a new filling can be obtained as in Case A1 or Case B3 of Proposition 14. We leave the details to the reader.

Proposition 21. *Let $D_{\lambda/\mu}$ be a strange diagram. Suppose $\mathbb{B}_{x-1,y} \notin P_{m-1}$. Then*

$$\lambda = \{m > m-1 > \dots > 1\} \text{ and } \mu = \{\mu_1 > \dots > \mu_l\}$$

where $l < m-1$.

Proof. It suffices to show that there does not exist any y' such that $\mathbb{B}_{x+1,y'} \in D_{\lambda/\mu}$. Suppose there exists such a y' , and without loss of generality assume that y' is the smallest integer with this property. Suppose $\mathbb{B}_{x,y'} \in P_r$. Then by Lemmas 7 and 8 it follows that

$$\mathbb{B}_{x-m+r,y+m-r}, \mathbb{B}_{x-m+r,y+m-r+1} \in P_r.$$

Now the following procedure provides a new amenable filling.

Step 1. Set $j = r$ and do $\mathbb{B}_{x-m+r,y+m-r+1} \leftarrow r$.

Step 2. If $j < m$ then do $\mathbb{B}_{x-m+j,y+m-j} \leftarrow j+1$ and $\mathbb{B}_{x-m+j+1,y+m-j} \leftarrow j+1$.

Step 3. If $j = m$ then do $\mathbb{B}_{x-m+j,y+m-j} \leftarrow m+1$ and stop.

Step 4. Increase j by one. Go back to Step 2. □

The proof of the following proposition is very similar to those of Propositions 18 and 14, and therefore we omit its proof.

Proposition 22. *Let $D_{\lambda/\mu}$ be a strange diagram given as in Case III and suppose $\mathbb{B}_{x-1,y} \in P_{m-1}$. Then λ, μ are given as in Corollary 15.*

Corollary 23. *Let $D_{\lambda/\mu}$ be a strange diagram given as in Case III. Then $D_{\lambda/\mu}$ is given either by the partitions of Corollary 15 or by the partitions of Proposition 21.*

3.7. Proof of uniqueness. In the previous sections we showed that the only diagrams which could possibly be strange are those listed in Theorem 6. In this section we prove that all of those diagrams are indeed strange. First we need a simple property of any arbitrary GSYT.

Lemma 24. *Let T be an amenable GSYT and let $w(T)$, the row word of T , have length n . Then for any $k > 1$ such that $m_{k-1}(n) > 0$ we have $m_k(n) < m_{k-1}(n)$.*

Proof. From Definition 3 it follows that for any $k > 1$, $m_k(n) \leq m_{k-1}(n)$. Suppose $m_{k-1}(n) = m_k(n)$. Then it follows from Definition 3 that if j_k (respectively j_{k-1}) is the smallest integer such that $w_{j_k} = k$ (respectively $w_{j_{k-1}} = k-1$) then $j_k < j_{k-1}$. The fourth part of Definition 3 implies that $w_j \neq \overline{k-1}$ for any $j < j_{k-1}$. Since $m_{k-1}(j) \geq m_k(j)$ for any $j \in \{0, \dots, 2n-1\}$, it follows that $m_k(n + j_{k-1} - 1) = m_{k-1}(n + j_{k-1} - 1) = m_{k-1}(n)$. But then $w_{j_{k-1}} = k-1$, which contradicts the second part of Definition 3. □

It is obvious that if $D_{\lambda/\mu} = D_\lambda$ then $D_{\lambda/\mu}$ is strange. Next we prove that if $D_{\lambda/\mu}$ is given by partitions of Corollary 15 then $D_{\lambda/\mu}$ is a strange diagram. We will present the argument only for the case $\lambda = \{p+q+r > p+q+r-1 > p+q+r-2 > \dots > p\}$ and $\mu = \{q > q-1 > \dots > 1\}$ where p, q, r are integers such that $p, q \geq 1, r \geq 0$. The other case can be treated in a very similar fashion.

Proposition 25. *Let $D_{\lambda/\mu}$ be given by $\lambda = \{p+q+r > p+q+r-1 > p+q+r-2 > \dots > p\}$ and $\mu = \{q > q-1 > \dots > 1\}$ where p, q, r are integers such that $p, q \geq 1, r \geq 0$. Then $D_{\lambda/\mu}$ is a strange diagram.*

We give the proof of Proposition 25 through Lemma 26, Lemma 27 and Lemma 28. Let us assume that $\mathbb{B}_{x,y}$ is the top right box of the diagram $D_{\lambda/\mu}$. Let n denote the number of boxes of $D_{\lambda/\mu}$. We consider an arbitrary amenable filling of $D_{\lambda/\mu}$ and show that it has to be the one obtained by the algorithm of section 3.1.

Lemma 26. *For any integers k, x' such that $k \geq 0$ and $x - p - r + 2 + k \leq x' \leq x$, if $\mathbb{B}_{x', y-k} \in D_{\lambda/\mu}$ then it should be filled by a $k + 1$.*

Proof. We prove this lemma by induction on k . For $k = 0$, the above statement follows from the fact that we should have $\mathbb{B}_{x, y} \in \{\bar{1}, 1\}$ and moreover no two $\bar{1}$'s can lie within the same row. Next assume $k \geq 1$. Let x' be chosen as above. Then by induction hypothesis, the boxes $\mathbb{B}_{x', y-k+1}, \mathbb{B}_{x'-1, y-k+1}$ are filled by k . Moreover, none of the rows which lie above the box $\mathbb{B}_{x, y-k}$ can contain an element of \mathcal{A} which is strictly larger than k , because their rightmost boxes are filled by elements less than or equal to k . Consequently, $\mathbb{B}_{x, y-k}$ should be filled by an element of $\{\overline{k+1}, k+1\}$. (Note that $\mathbb{B}_{x, y-k+1}$ contains a k .) This in turn limits the entries of $\mathbb{B}_{x', y-k}$ and $\mathbb{B}_{x'-1, y-k}$ to $\{\overline{k+1}, k+1\}$. However, if $\mathbb{B}_{x', y-k}$ is filled by a $\overline{k+1}$ then $\mathbb{B}_{x'-1, y-k}$ should also be filled by a $\overline{k+1}$, which is a contradiction by Definition 1. Therefore $\mathbb{B}_{x', y-k}$ has to be filled by a $k + 1$. \square

Lemma 26 implies that for any $k \geq 1$, if there is at least one box in $D_{\lambda/\mu}$ filled by a k , then there are at least $p + r - k$ boxes in $D_{\lambda/\mu}$ which are filled by a k . Note that since $D_{\lambda/\mu}$ has $p + r$ columns, there can be at most $p + r$ boxes which are filled by a 1. Lemma 24 implies that there can be at most $p + r - k + 1$ boxes which are filled by a k . We will see below that actually the latter possibility takes place. More accurately, we show that if there is at least one k in the filling of $D_{\lambda/\mu}$, then there are exactly $p + r - k + 1$ of them.

Lemma 27. *The largest integer that appears in the filling of $D_{\lambda/\mu}$ is $\min\{p + r, q + r + 1\}$. For any $k \in \{1, \dots, \min\{p + r, q + r + 1\}\}$ there are exactly $p + r - k + 1$ boxes in $D_{\lambda/\mu}$ which contain a k .*

Proof. If $p + r > q + r + 1$ then by Lemma 26 the box $\mathbb{B}_{x, y-q-r}$ is filled by a $q + r + 1$. But $\mathbb{B}_{x, y-q-r}$ is the rightmost box of the lowest row of $D_{\lambda/\mu}$, and since the rows and columns of a filling are weakly increasing, all of the boxes have to be filled by elements of \mathcal{A} which are less than or equal to $q + r + 1$. Now Lemma 26 implies that $\mathbb{B}_{x+q-p+2, y-q-r}$ contains a $q + r + 1$ and $\mathbb{B}_{x+q-p+1, y-q-r+1}$ contains a $q + r$. Because of the shape of $D_{\lambda/\mu}$ we can see that $\mathbb{B}_{x+q-p+1, y-q-r} \in D_{\lambda/\mu}$. Since $\mathbb{B}_{x+q-p+1, y-q-r+1}$ contains a $q + r$, the entry of $\mathbb{B}_{x+q-p+1, y-q-r}$ should belong to $\{\overline{q+r+1}, q+r+1\}$. But the entry of $\mathbb{B}_{x+q-p+1, y-q-r}$ cannot be $q + r + 1$ because this implies that the leftmost occurrence of an element of $\{\overline{q+r+1}, q+r+1\}$ in the row word of the filling is marked. Consequently, $\mathbb{B}_{x+q-p+1, y-q-r}$ is filled by a $q + r + 1$ which implies that $m_{q+r+1}(n) \geq p - q$. Now we have

$$p + r \geq m_1(n) > \dots > m_{q+r+1}(n) \geq p - q$$

which implies that $m_k(n) = p + r - k + 1$ for any $k \in \{1, \dots, q + r + 1\}$.

If $p + r \leq q + r + 1$, then Lemma 26 implies that $\mathbb{B}_{x, y-p-r+2}$ has to be filled by $p + r - 1$. Now $\mathbb{B}_{x, y-p-r+1} \in D_{\lambda/\mu}$ and therefore it should be filled by an element of \mathcal{A} which is larger than $p + r - 1$. Consequently, $m_{p+r}(n) > 0$. Now by Lemma 24, we have

$$p + r \geq m_1(n) > \dots > m_{p+r}(n) \geq 1$$

which implies that $m_k(n) = p + r + 1 - k$. In particular, $m_k(n) > 0$ if and only if $k \leq p + r$. \square

Let $M = \min\{q + r + 1, p + r\}$. By Lemma 27, for any $1 \leq k \leq M$ there are exactly $p + r - k + 1$ boxes which contain a k . Lemma 26 determines the position of $p + r - k$ of these boxes uniquely. Therefore for any $k \leq M$, the location of precisely one box containing a k is left to be determined. In fact it turns out that after the location of this box is determined, the entire filling is also determined uniquely. See Lemma 28 below.

Lemma 28. *Let $x' \in \{x, x - 1, \dots, x - p - r + 1\}$ and let y' be the smallest integer such that $\mathbb{B}_{x', y'} \in D_{\lambda/\mu}$. Then*

- *If $x' \leq x - p - r + M$ then $\mathbb{B}_{x', y'}$ has to be filled with an $x' - x + p + r$.*
- *For any y'' such that $y' + 1 \leq y'' \leq y - x' + x - p - r + 1$, the box $\mathbb{B}_{x', y''}$ has to be filled with a $\overline{x' - x + p + r}$.*

Proof. Let $b(x')$ be the entry of the box $\mathbb{B}_{x',y'}$ of the statement of the lemma. Since the rows and columns are weakly increasing we have

$$b(x-p-r+1) \leq b(x-p-r+2) \leq \cdots b(x-p-r+M)$$

where the inequalities are interpreted in the ordering of \mathcal{A} . From Definition 3 it follows that $b(x-p-r+j)$ should be unmarked for any $j \in \{1, \dots, M\}$. In fact assume on the contrary that $b(x-p-r+j) = \bar{l}$ for some l . Let $x' = x-p-r+j$ and y' be such that $b(x-p-r+j)$ be the entry of the box $\mathbb{B}_{x',y'}$. By Definition 3 there should exist a box $\mathbb{B}_{x'',y''}$ such that $y'' < y'$ and $\mathbb{B}_{x'',y''}$ is filled by an l . From the shape of $D_{\lambda/\mu}$ it follows that $x'' > x'$. But then $\mathbb{B}_{x'',y''} \in D_{\lambda/\mu}$ and it is impossible to fill the latter box such that Definition 1 holds.

Since $b(x-p-r+j)$ is unmarked for any $j \in \{1, \dots, M\}$ and there is exactly one box filled by a j whose location is not determined by Lemma 26, it turns out that $b(x-p-r+j) = j$ for any such j .

Finally, $\mathbb{B}_{x',y'}$ lies below a box filled by an $x' - x + p + r - 1$ and above a box filled by an $x' - x + p + r$. Consequently, its entry has to be $x' - x + p + r$. □

The proof of Proposition 25 is completed by Lemma 28. The following proposition completes the proof of Theorem 6.

Proposition 29. *Let $D_{\lambda/\mu}$ be given by $\lambda = \{m > \cdots > 1\}$ and $\mu = \{\mu_1 > \cdots > \mu_l\}$ such that $l < m - 1$. Then $D_{\lambda/\mu}$ is a strange diagram.*

The rest of this section is devoted to the proof of Proposition 29. Suppose $D_{\lambda/\mu}$ has p columns and n boxes. This means that $p = m - l$ and $n = \frac{m(m+1)}{2} - (\mu_1 + \cdots + \mu_l)$. Let $w = w(T)$ be the row word of the filling of $D_{\lambda/\mu}$. w can be expressed as $w = w_1 \cdots w_n$ where each $w_i \in \mathcal{A}$. Since each column of $D_{\lambda/\mu}$ contains at most one box filled by 1, $m_1(n) \leq p$. Lemma 24 implies that

$$(3) \quad m_k(n) \leq p - k + 1 \text{ for any } k \in \{1, \dots, p\}.$$

Let $\mathbb{B}_{x,y}$ denote the box in the lowest row of $D_{\lambda/\mu}$. (Note that there is only one box in the lowest row.) For any $i \in \{0, \dots, p-1\}$ let b_i denote the entry of the box $\mathbb{B}_{x-i,y+i}$. Since rows and columns are weakly increasing, the b_i 's form a decreasing sequence in \mathcal{A} ; i.e.

$$(4) \quad b_0 > \cdots > b_{p-1}.$$

Lemma 30. $b_i = p - i$ for any $i \in \{0, \dots, p-1\}$.

Proof. First we show that all the b_i 's are unmarked. Suppose on the contrary that for integers i and l , $b_i = \bar{l}$. Then by Definition 3, there should be a box $\mathbb{B}_{u,v}$ such that $u > x - i$, $v < y - i$ and the entry of $\mathbb{B}_{u,v}$ is l . But then it will be impossible to choose an entry for $\mathbb{B}_{u,y-i}$ so that Definition 1 holds. Therefore b_i cannot be marked for any i . From equation (3) it is clear that $b_0 \leq p$.

It is now easy to use (4) to prove that $b_i = p - i$. □

Definition 31. A diagonal D_s in $D_{\lambda/\mu}$ is the set of boxes given by

$$D_s = \{\mathbb{B}_{x',y'} \mid x' + y' = x + y + s\} \cap D_{\lambda/\mu}.$$

If $D_s \neq \emptyset$ then we can express it as

$$D_s = \{\mathbb{B}_{x_s, y_s}, \mathbb{B}_{x_s+1, y_s-1}, \dots, \mathbb{B}_{x_s+l_s, y_s-l_s}\}$$

for some integer $l_s \geq 0$.

Our approach is to prove inductively that the entries of boxes in every D_s are uniquely determined. The basis of induction is $s = 0$, which follows from Lemma 30.

Lemma 32. *Fix $i \in \{0, \dots, p-1\}$. Let $z > y + i$ be an integer such that $\mathbb{B}_{x-i,z} \in D_{\lambda/\mu}$. Then the entry of $\mathbb{B}_{x-i,z}$ is an element of \mathcal{A} strictly less than $p - i$.*

Proof. This is because $\mathbb{B}_{x-i,z}$ lies above $\mathbb{B}_{x-i,y+i}$ which is filled by a $p-i$. \square

Now let D_s and D_{s+1} be two successive nonempty diagonals of $D_{\lambda/\mu}$. We can express them as

$$D_s = \{\mathbb{B}_{x_s, y_s}, \dots, \mathbb{B}_{x_s+l_s, y_s-l_s}\} \text{ and } D_{s+1} = \{\mathbb{B}_{x_{s+1}, y_{s+1}}, \dots, \mathbb{B}_{x_{s+1}+l_{s+1}, y_{s+1}-l_{s+1}}\}$$

where $l_s, l_{s+1} \geq 0$. It can be seen that one of the following cases can happen:

- $x_{s+1} = x_s + 1$ and $y_{s+1} = y_s$. In this case $l_{s+1} = l_s - 1$.
- $x_{s+1} = x_s$ and $y_{s+1} = y_s + 1$. In this case $l_{s+1} = l_s$.

From Lemma 30 it follows that $b_0 = p$, i.e. $m_p(n)=1$. Now Lemma 24 implies that $m_k(n) = p - k + 1$. The following lemma now follows immediately from Lemma 32.

Lemma 33. *For any k such that $p \geq k \geq 1$ and any $u \geq x - p + k$ there exists an integer v such that $\mathbb{B}_{u,v}$ is filled by a k .*

Next we prove the following lemma, which completes the proof of Proposition 29.

Lemma 34. *The entries of the boxes of D_{s+1} are given according to the following rules:*

- If $y_{s+1} = y_s + 1$ then for any $i \in \{0, \dots, l_{s+1}\}$ the entry of $\mathbb{B}_{x_{s+1}+i, y_{s+1}-i}$ is $\overline{i+1}$.
- If $x_{s+1} = x_s + 1$ then for any $i \in \{0, \dots, l_{s+1}\}$ the entry of $\mathbb{B}_{x_{s+1}+i, y_{s+1}-i}$ is $i+1$.

Proof. We use induction on i . Namely, we assume that the entries of the boxes in D_s are given according to the rules stated in the lemma, and then we use induction on i to prove that the entry of $\mathbb{B}_{x_{s+1}+i, y_{s+1}-i}$ is given according to the rules in the statement of the lemma as well.

Case 1. Obviously $\mathbb{B}_{x_{s+1}, y_{s+1}} = \overline{1}$, since it lies above the box \mathbb{B}_{x_s, y_s} whose entry belongs to $\{1, \overline{1}\}$. This amounts for the basis of induction, i.e. $i = 0$. Next suppose $i > 0$. Then $\mathbb{B}_{x_{s+1}+i, y_{s+1}-i}$ lies to the right of $\mathbb{B}_{x_s+i-1, y_s-i+1}$ and above $\mathbb{B}_{x_s+i, y_s-i}$. However, by our assumption about D_s , the entries of the latter two boxes, which belong to D_s , are known. A simple argument based on monotonicity of rows and columns implies that if b is the entry of $\mathbb{B}_{x_{s+1}+i, y_{s+1}-i}$ then $b \in \{i, \overline{i+1}\}$. It suffices to show that $b = i$ is impossible. The proof is by contradiction. Suppose on the contrary that $b = i$. By induction hypothesis we know that $\mathbb{B}_{x_{s+1}+i-1, y_{s+1}-i+1}$ is filled by \overline{i} , which implies that it is impossible to choose an entry for $\mathbb{B}_{x_{s+1}+i, y_{s+1}-i+1}$ such that Definition 1 holds. Consequently, $b = \overline{i+1}$.

Case 2. First note that $\mathbb{B}_{x_{s+1}+i, y_{s+1}-i}$ lies to the right of $\mathbb{B}_{x_s+i, y_s-i}$ and above $\mathbb{B}_{x_s+i+1, y_s-i-1}$. But the entries of the latter two boxes are known, and a simple argument based on monotonicity of rows and columns implies that if b is the entry of $\mathbb{B}_{x_{s+1}+i, y_{s+1}-i}$ then $b \in \{i+1, \overline{i+2}\}$. Next we show that b cannot be equal to $\overline{i+2}$. Suppose on the contrary that $b = \overline{i+2}$. Suppose b corresponds to the letter w_{u_1} of the row word of the filling. Then by a bookkeeping argument we have

$$m_{i+1}(n + u_1) = m_{i+2}(n + u_1).$$

By Lemma 32 and Lemma 33 there exists a z such that the box $\mathbb{B}_{x_{s+1}+i, z}$ is filled by an $i+1$. Obviously $z > y_{s+1} - i$. Let the entry of $\mathbb{B}_{x_{s+1}+i, z}$ correspond to w_u . Then there should exist an integer u' such that $u_1 < u' < u$ and $w_{u'} = \overline{i+1}$, because otherwise we will have $m_{i+1}(n + u - 1) = m_{i+2}(n + u - 1)$ and $w_u = i+1$ which contradicts the second property of Definition 3.

However, existence of u' leads to a contradiction too. In fact $w_{u'}$ should correspond to a box $\mathbb{B}_{x'', y''}$ such that either $y'' < z$ or $y'' = z$ and $x'' < x_{s+1} + i$. However, if $x'' < x_{s+1} + i$ and $y'' > y_{s+1} - i$ then $\mathbb{B}_{x'', y''}$ lies above $\mathbb{B}_{x_{s+1}+j, y_{s+1}-j}$ for some $j < i$, and therefore the entry of $\mathbb{B}_{x'', y''}$ should be strictly less than $\overline{i+1}$. (Note that if $i > 0$ then by induction hypothesis $\mathbb{B}_{x_{s+1}+i-1, y_{s+1}-i+1} = i$ and if $i = 0$ then $\mathbb{B}_{x_{s+1}+i-1, y_{s+1}-i+1} \notin D_{\lambda/\mu}$.) If $x'' = x_{s+1} + i$ and $y'' < z$ then $\mathbb{B}_{x'', y''}$ lies below $\mathbb{B}_{x_{s+1}+i, z}$ and therefore its entry should be strictly larger than $i+1$. Finally, if $x'' > x_{s+1} + i$ and $y'' < z$, then $\mathbb{B}_{x'', z} \in D_{\lambda/\mu}$ but it is impossible to choose its entry such that Definition 1 holds. Therefore all of these cases lead to a contradiction. \square

REFERENCES

- [BTW] Billera, Louis and Thomas, Hugh and van Willigenburg, Stephanie, *Decomposable compositions, symmetric quasisymmetric functions and equality of ribbon Schur functions*, preprint (2005), accepted in Adv. Math.
- [Bes] Bessenrodt, Christine On multiplicity-free products of Schur P -functions. Ann. Comb. 6 (2002), no. 2, 119–124.
- [St1] Stembridge, John R. *Shifted tableaux and the projective representations of symmetric groups*. Adv. Math. 74 (1989), no. 1, 87–134.
- [St2] Stembridge, John R. *Multiplicity-free products of Schur functions*. Ann. Comb. 5 (2001), no. 2, 113–121.
- [Wi] van Willigenburg, Stephanie Equality of Schur and skew Schur functions. Ann. Comb. 9 (2005), no. 3, 355–362.

DEPARTMENT OF MATHEMATICS AND STATISTICS, QUEEN'S UNIVERSITY, JEFFERY HALL, UNIVERSITY AVENUE,
KINGSTON, ON K7L 3N6, CANADA

E-mail address: `hadi@mast.queensu.ca`