

# TANGENT BUNDLE AND GAUSS FUNCTOR OF A COMBINATORIAL MANIFOLD.

Nikolai Mnëv

PDMI RAS,  
Fontanka 27,  
Saint-Petersburg, Russia  
mnev@pdmi.ras.ru

This note is as an extended talk at the workshop “Combinatorial Geometries and Applications: Oriented Matroids and Matroids” Marseille-Luminy, November 7-11, 2005.

0.1. **Introduction.** To any poset  $\mathbf{P}$  we associate a poset map  $EP \xrightarrow{TP} \mathbf{P}$  accomplished by two sections  $\mathbf{P} \xrightarrow{s_0, s_\infty} EP$  and a functor  $\mathbf{P} \xrightarrow{\mathbf{G}} \mathbf{Posets}$ . Functor  $\mathbf{G}$  is related to the map  $TP$  in such a way that  $EP \xrightarrow{TP} \mathbf{P}$  coincides with  $\text{Hocolim } \mathbf{G} \xrightarrow{\Pi} \mathbf{P}$ .

In [Mnë] it is shown that in the case when  $\mathbf{P}$  is a “strict abstract manifold” (the examples are combinatorial manifolds and boundary complexes of arbitrary convex polytopes) the following happens. The order complex of  $EP$  is a combinatorial manifold. The map  $BEP \xrightarrow{BTP} BP$  together with two sections  $Bs_0, Bs_\infty$  is a Kuiper-Lashoff  $(S^n, 0, \infty)$  model for the tangent PL-bundle of  $BP$ . The image of functor  $\mathbf{G}$  naturally lives in a nice category  $\mathfrak{R}_n$ . The discrete category  $\mathfrak{R}_n$  can be viewed as a discrete replacement of the structure group for the discrete replacements of PL fiber bundles with fiber  $\mathbb{R}^n$ . The main statement is that this discretization is exact:  $B\mathfrak{R}_n \approx BPL_n$  and  $BP \xrightarrow{BG} B\mathfrak{R}_n$  is a homotopy model of PL Gauss map for the PL manifold  $BP$ . Here  $B*$  is the classifying space functor, which coincides in the case of posets with the geometric realization of the order complex, in the case of categories – with Milnor geometric realization of the nerve and in the case of simplicial group with the classifying space for principal bundles. These results can be viewed as a purely combinatorial variation of some constructions from [Lev89], [Hat75], [Ste86]. Also this proves the PL double for MacPherson’s conjecture on modeling the real

---

Supported by RFBR grant 05-01-00899 and S.S. grant 4329.2006.1.

Grassmanian  $BO_n$  by the poset of oriented matroids [Mac78],[Mac93] (see [MZ93]). Here we formulate these results and briefly discuss their proofs from [Mnë].

**0.2. Tangent bundle and Gauss map of a PL manifold.** Milnor in [Mil61] defined the notion of  $n$ -dimensional PL microbundle, the simplicial structure group  $PL_n$  of microbundles and the classifying space  $BPL_n$ . This theory creates canonical one-to-one correspondence between isomorphism classes of  $n$ -dimensional PL microbundles on a polyhedron  $K$  and homotopy classes of maps from  $K$  to  $BPL_n$ . Milnor also defined the notion of tangent microbundle of a PL manifold  $M^n$ . A map  $M^n \xrightarrow{G} BPL_n$  representing tangent microbundle of  $M^n$  is called *Gauss map* of  $M^n$  and  $BPL_n$  is a PL *Grassmanian*. The space  $BPL_n$  and the Gauss map are defined up to homotopy. In [KL66a] and [KL66b] Kuiper and Lashof developed the theory of models for piecewise-linear  $\mathbb{R}^n$ -bundles. In particular they established a canonical one-to-one correspondence between isomorphism classes of  $n$ -dimensional PL microbundles and  $(S^n, \infty)[(S^n, 0, \infty)]$  fiber bundles. A piecewise-linear  $(S^n, \infty)$  fiber bundle is a PL fiber bundle with fiber  $S^n$  and a section labeled by  $\infty$ . A piecewise-linear  $(S^n, 0, \infty)$  fiber bundle is a PL fiber bundle with fiber  $S^n$  and two sections labeled by 0 and  $\infty$ . This sections should have no points in common.

**0.3. Tangent bundle and Gauss functor of a poset.** Here we introduce a very general and useless in its full generality construction.

Let  $\mathbf{P}$  be a poset, let  $p \in \mathbf{P}$ . We introduce a notation  $\text{Star } p$  for the subposet of  $\mathbf{P}$  which is a union of all principal ideals containing  $p$ . Formally:

$$\text{Star } p = \{x \in \mathbf{P} \mid \exists y : p \leq y, x \leq y\}$$

We also introduce a notation

$$\text{Link } p = \{x \in \text{Star } p \mid p \not\leq x\}$$

Define a new poset  $\text{EP}$  as follows. Denote by  $DP$  a subset of  $\mathbf{P} \times \mathbf{P}$ , formed by all pairs  $(x, y)$  such that  $\exists z \in \mathbf{P} : z \geq x, z \geq y$ . Pick a new element  $\infty \notin \mathbf{P}$ . Set

$$\text{EP} = DP \cup \mathbf{P} \times \{\infty\} \subset \mathbf{P} \times \mathbf{P} \cup \{\infty\}$$

Now we define a partial order on  $\text{EP}$ . Set

$$(x_1, y_1) \leq (x_2, y_2) \Leftrightarrow (x_1 \leq_{\mathbf{P}} x_2) \wedge \begin{cases} y_1 \leq_{\mathbf{P}} y_2 & \text{if } y_1, y_2 \in \mathbf{P} \\ y_1 \in \text{Link}_{\mathbf{P}} x_2 & \text{if } y_1 \in \mathbf{P}, y_2 = \infty \\ y_1 = \infty, y_2 = \infty & \end{cases}$$

Set by  $\text{EP} \xrightarrow{\text{TP}} \mathbf{P}$  the projection on first argument. We fix two sections of the poset map  $\text{TP}$ : the diagonal

$$\mathbf{P} \xrightarrow{s_0} \text{EP}, s_0(x) = (x, x) \in DP \subset \text{EP}$$

and the “section at infinity”:

$$\mathbf{P} \xrightarrow{s_\infty} \mathbf{EP}, s_\infty(x) = (x, \infty)$$

We call the defined above set of data  $\langle \mathbf{TP}, s_0, s_\infty \rangle$  the *tangent bundle of a poset P*.

To any element  $x \in \mathbf{P}$  there corresponds a subposet  $\mathbf{G}_x = (\mathbf{TP})^{-1}(x) \subset \mathbf{EP}$  with induced order. We can describe the structure of  $\mathbf{G}_x$ :

$$\mathbf{G}_x = \{(x, y) | y \in \text{Star}_{\mathbf{P}} x\} \cup \{(x, \infty)\}$$

$$(x, y_1) \underset{\mathbf{G}_x}{\leq} (x, y_2) \Leftrightarrow \begin{cases} y_1 \underset{\mathbf{P}}{\leq} y_2 & \text{if } y_1, y_2 \in \mathbf{P} \\ y_1 \in \text{Link}_{\mathbf{P}} x & \text{if } y_2 = \infty \\ y_1 = \infty, y_2 = \infty & \end{cases}$$

We will call the special diagonal element  $(x, x) \in \mathbf{G}_x$  the 0-element.

To any pair  $x_1 \leq x_2$  of comparable elements in  $\mathbf{P}$  we associate a poset map

$$\mathbf{G}_{x_1} \xrightarrow{\mathbf{G}_{x_1 \leq x_2}} \mathbf{G}_{x_2}$$

defined as follows

$$\mathbf{G}_{x_1 \leq x_2}(x_1, y) = \begin{cases} (x_2, y) & \text{if } y \in \text{Star } x_2 \\ (x_2, \infty) & \text{if } y \notin \text{Star } x_2 \\ (x_2, \infty) & \text{if } y = \infty \end{cases}$$

Consider the category  $\mathbf{Posets}^{0, \infty}$  of all posets having two elements specially labelled. One is element is labelled by 0 and another by  $\infty$ . The morphisms of  $\mathbf{Posets}^{0, \infty}$  are the poset maps preserving labelled elements. The poset maps  $\mathbf{G}_{x_1 \leq x_2}$  preserve the elements marked by 0 (diagonal) and by  $\infty$ . So we can regard  $\mathbf{G}$  as a functor  $\mathbf{P} \xrightarrow{\mathbf{G}} \mathbf{Posets}^{0, \infty}$ . We will call  $\mathbf{G}$  the *Gauss functor of a poset P*.

The tangent bundle  $\langle \mathbf{TP}, s_0, s_\infty \rangle$  can be identified with certain classical construction associated with  $\mathbf{G}$ . The construction is known by the names of “categorical homotopy colimit”, or “Grothendieck construction” [GJ99] or “double bar construction” [May75] Probably it’s first indication is in Whitehead’s construction of the cone of simplicial map [Whi39]. In our situation the construction looks as follows. Let  $\mathbf{P}$  be a poset and let  $\mathbf{F}$  be any functor  $\mathbf{P} \xrightarrow{\mathbf{F}} \mathbf{Posets}$ . With functor  $\mathbf{F}$  we associate a new poset  $\text{Hocolim } \mathbf{F}$  and a poset map  $\text{Hocolim } \mathbf{F} \xrightarrow{\Pi} \mathbf{P}$ . Put

$$\text{Hocolim } \mathbf{F} = \{(x, y) | x \in \mathbf{P}, y \in \mathbf{F}_x\}$$

and define  $(x_0, y_0) \leq (x_1, y_1)$  iff  $x_0 \leq_{\mathbf{P}} x_1$  and  $\mathbf{F}_{x_0 \leq_{\mathbf{P}} x_1}(y_0) \leq_{\mathbf{F}_{x_1}} y_1$ . The projection  $\text{Hocolim } \mathbf{F} \xrightarrow{\Pi} \mathbf{P}$  is a projection on the first argument. With a functor  $\mathbf{P} \xrightarrow{\mathbf{H}} \mathbf{Posets}^{0,\infty}$  we associate three functors to  $\mathbf{P} \rightarrow \mathbf{Posets}$ . One is the composite of  $\mathbf{H}$  and forgetful functor (we denote it by  $\tilde{\mathbf{H}}$ ). The two others are constant functors  $\mathbf{0}, \infty$ , sending entire  $\mathbf{P}$  to 0 and entire  $\mathbf{P}$  to  $\infty$ . The triad

$$(\text{Hocolim } \tilde{\mathbf{H}}, \text{Hocolim } \mathbf{0}, \text{Hocolim } \infty)$$

is exactly  $\text{Hocolim } \tilde{\mathbf{H}}$  together with the graphs of two sections  $s_0$  and  $s_\infty$  of projection  $\Pi$ . So, the  $\text{Hocolim}$  of a functor with values in  $\mathbf{Posets}^{0,\infty}$  is naturally equipped with 0 and  $\infty$  sections of projection  $\Pi$

The only essential property of our general construction of the tangent bundle and Gauss functor of a poset  $\mathbf{P}$  is that the tangent bundle  $\langle \text{EP} \xrightarrow{\text{TP}} \mathbf{P}, s_0, s_\infty \rangle$  coincides with  $\langle \text{Hocolim } \tilde{\mathbf{G}} \xrightarrow{\Pi} \mathbf{P}, s_0, s_\infty \rangle$ .

**0.4. Abstract manifolds.** Here we define a slight generalization of Alexander's combinatorial manifold. For the reference on combinatorial topology of posets and ball complexes one may use [Bjö95].

A *PL-ball complex* is a pair  $(X, U)$ , where  $X$  is a compact Euclidean polyhedron and  $U$  is a covering of  $X$  by closed PL-balls such that the following axioms are satisfied:

**plbc1:** the relative interiors of balls from  $U$  form a partition of  $X$ .

**plbc2:** The boundary of each ball from  $U$  is a union of balls from  $U$ .

A PL-ball complex is defined up to PL-homeomorphism only by the combinatorics of adjunctions of its balls. Let  $\mathcal{D}$  be a PL-ball complex. Consider the poset  $\mathbf{P} = \mathbf{P}(\mathcal{D})$  of all its balls ordered by inclusion. Then  $\mathcal{D}$  is cellular complex PL-homeomorphic to the complex  $(B\mathbf{P}, \{B\mathbf{P}_{\leq p}\}_{p \in \mathbf{P}})$ . Here  $\mathbf{P}_{\leq p}$  is the principal ideal. For a poset  $\mathbf{Q}$  we denote by  $B\mathbf{Q}$  the geometric realization of the order complex of  $\mathbf{Q}$ .

This makes possible to define an abstract PL-ball complex: a finite poset  $\mathbf{P}$  is called by *abstract PL-ball complex* if for any  $p \in \mathbf{P}$  the polyhedron  $B\mathbf{P}_{< p}$  is a PL sphere. If  $\mathbf{P}$  is an abstract ball complex then  $(B\mathbf{P}, \{B\mathbf{P}_{\leq p}\}_{p \in \mathbf{P}})$  is a PL-ball complex [Bjö84].<sup>1</sup> We will call The principal ideals of an abstract ball complex  $\mathbf{P}$  by its *balls*. A poset  $\mathbf{P}$  is *pure* if all maximal chains have the same length. A pure poset  $\mathbf{P}$  is an *abstract manifold* if both  $\mathbf{P}$  and  $\mathbf{P}^{\text{op}}$  are abstract PL-ball complexes. Here  $\mathbf{P}^{\text{op}}$  is  $\mathbf{P}$  with the opposite order. If  $\mathbf{P}$  is an abstract manifold then the simplicial complex  $\text{Ord } \mathbf{P}$  is a combinatorial manifold in the classical meaning of Alexander.

---

<sup>1</sup>The classical combinatorial characterization of ball complexes is in topological category, not in PL category, but for the PL case the theory works without any changes.

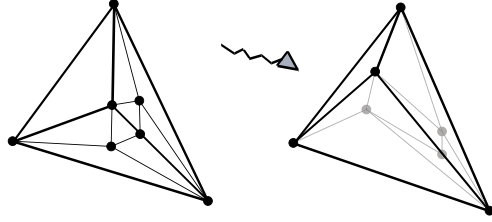

FIGURE 1. Abstract aggregation.

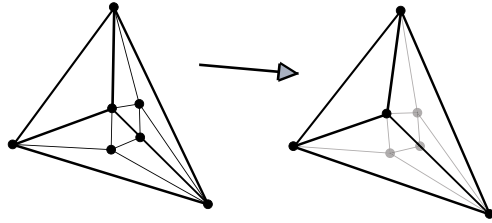

FIGURE 2. Geometric aggregation.

Let  $P_0, P_1$  be the abstract manifolds. Call a poset map  $P_0 \xrightarrow{\xi} P_1$  an *aggregation morphism* if for any rank  $k$  ball  $O$  of  $P$  the polyhedron  $B\xi^{-1}(O)$  is a  $k$ -dimensional PL-ball.

An aggregation morphism  $\xi$  can be realized up to isomorphism as a geometric aggregation of PL-ball complex structures on  $BP_0$ . Consider the ball complex structure  $(BP_0, \{BP_{0 \leq p}\}_{p \in P_0})$  on  $BP_0$ . Then after glueing together all the balls which are sent the same ball of  $P_1$  by morphism  $\xi$  we will get a geometric representation of  $P_1$  up to an isomorphism. Figure 1 illustrates abstract aggregation and Figure 2 – geometric aggregation. The composition of aggregation morphisms is an aggregation morphism.

Let us call *abstract  $n$ -sphere* an abstract manifold  $P$  such that polyhedron  $BP$  is PL-homeomorphic to  $S^n$ . Consider the category  $\mathfrak{R}_n$  where the objects are abstract  $n$ -spheres having one element of maximal rank specially labelled by “ $\infty$ ”. Morphisms of  $\mathfrak{R}_n$  are the aggregations sending the  $\infty$ -element to the  $\infty$ -element. So,  $\mathfrak{R}_n$  is a subcategory of the category  $\mathbf{Posets}^\infty$  of all posets with fixed element labelled by “ $\infty$ ”.

We need one more definition. An abstract  $n$ -dimensional manifold  $\mathbf{P}$  is *strict* if for any  $x \in \mathbf{P}$  the pair of polyhedra  $(B \text{ Star } x, B \text{ Link } x)$  is PL-homeomorphic to the pair  $(D^n, S^{n-1})$ . The examples of strict abstract manifolds are the simplex posets of combinatorial manifolds and face posets of convex polytopes.

**0.5. Tangent bundle and Gauss functor of a strict abstract manifold.** Now we can formulate our theorem about the tangent bundle of a poset in the case of strict abstract manifold. The general message is that in the case of strict abstract manifolds (§0.4) the abstract construction (§0.3) represents the classical geometrical one (§0.2).

Let  $\mathbf{M}^n$  be a strict abstract  $n$ -dimensional manifold. Denote by  $\mathbf{M}^n \xrightarrow{\mathbf{G}^\infty} \mathbf{Posets}^\infty$  the composition of the Gauss functor  $\mathbf{G}$  and forgetful functor  $\mathbf{Posets}^{0,\infty} \rightarrow \mathbf{Posets}^\infty$ . We will also call the functor  $\mathbf{G}^\infty$  “Gauss functor”.

**Theorem 1.**

1. *The image of the Gauss functor  $\mathbf{M}^n \xrightarrow{\mathbf{G}^\infty} \mathbf{Posets}^\infty$  belongs to  $\mathfrak{A}_n$*
2. *The order complex of  $\mathbf{EM}^n$  is a combinatorial manifold*
3. *The PL-map  $B\mathbf{EM}^n \xrightarrow{B\mathbf{TM}^n} B\mathbf{M}^n$  together with two sections  $Bs_0, Bs_\infty$  is a Kuiper-Lashof  $(S^n, 0, \infty)$  model of the Milnor tangent bundle of  $B\mathbf{M}^n$ .*
4. *The space  $B\mathfrak{A}_n$  is homotopy equivalent to the space  $B\mathbf{P}L_n$ .*
5. *The map  $B\mathbf{M}^n \xrightarrow{B\mathbf{G}^\infty} B\mathfrak{A}_n$  is a homotopy model of the PL Gauss map of  $B\mathbf{M}^n$ .*

If one verifies the statement 1 then the statements 2 and 3 follow from Kuiper-Lashof theory, simple properties of Hocolim construction and Alexander’s trick. The statement 5 is a summary of 1-4 modulo standard abstract nonsense. The real thing to prove is the statement 4 ([Mnë, Theorem C]).

To verify 1 and overall naturalness of  $\mathbf{G}^\infty$  it is useful to consider the case when  $\mathbf{M}^n$  is the combinatorial sphere  $S^n$  (see Figure 3). Let  $s$  be a simplex of  $S^n$ . Then one can imagine  $\mathbf{G}^\infty(s) \in \mathfrak{A}_n$  as follows: glue together all the simplices of  $S^n$  which do not contain  $s$ . This will be our new ball of  $\mathbf{G}^\infty$  marked by  $\infty$ . The ball is naturally attached by  $\text{Link } s$  to  $\text{Star } s$  and altogether they form the sphere  $\mathbf{G}^\infty(s)$  with a marked  $\infty$ -ball. We should mention that while  $S^n$  is a combinatorial manifold, the “tangent sphere”  $\mathbf{G}^\infty(s)$  is an abstract manifold, since the  $\infty$ -ball is usually non-simplicial. Let  $s_0 \subset s_1$  be a pair of simplices of  $S^n$ . Then  $\text{Star } s_0 \supset \text{Star } s_1$ . When we pass from  $\mathbf{G}^\infty(s_0)$  to  $\mathbf{G}^\infty(s_1)$  the simplices from  $\text{Star } s_0 \setminus \text{Star } s_1$  are dissolve in  $\infty$ -ball of  $\mathbf{G}^\infty(s_1)$ . This operation is exactly the morphism  $\mathbf{G}_{s_0 \subset s_1}^\infty$  and as we see this is exactly an aggregation morphism from  $\mathfrak{A}_n$ . In the Figure 4 we show the cellular  $(S^1, 0, \infty)$  model of the tangent bundle of a triangle obtained by our recipe.

**0.6.  $B\mathfrak{A}_n \approx B\mathbf{P}L_n$ .** Now we will discuss the problem of proving the statement 4 of the Theorem 1. Let  $X$  be a compact PL manifold. Consider the category  $\mathfrak{A}(X)$  of

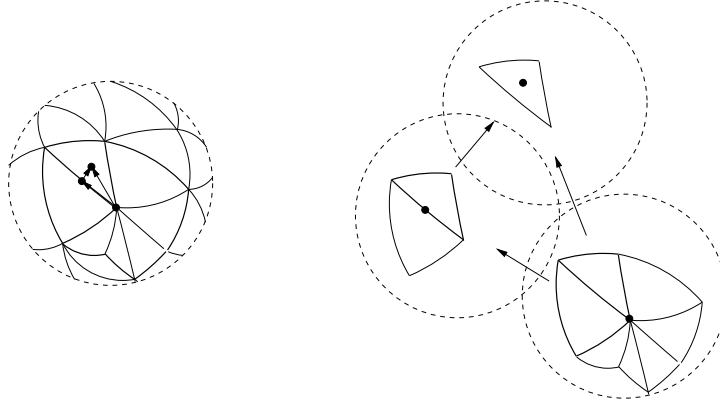

FIGURE 3. The Gauss functor of a combinatorial sphere

all abstract manifolds  $M$  such that the polyhedron  $BM$  is PL homeomorphic to  $X$ . The morphisms of  $\mathfrak{A}(X)$  are the aggregation morphisms. The Theorem A in [Mnë] states that

$$(1) \quad B\mathfrak{A}(X) \approx BPL(X)$$

where  $PL(X)$  is a simplicial group of PL homeomorphisms of  $X$ . The proof of the statement  $B\mathfrak{A}_n \approx BPL_n$  is a cosmetic variation of the general scheme developed for (1).

Let  $L$  be a PL polyhedron. We call an  $\mathfrak{A}(X)$ -coloring of  $L$  the following object: a linear triangulation  $K$  of  $L$ ,  $|K| = L$  and an assignment to any vertex of  $K$  an abstract manifold from  $\mathfrak{A}(X)$  and to any 1-simplex of  $K$  an aggregation morphism, in such a way that all 2-simplices of  $K$  become commutative triangles in  $\mathfrak{A}(X)$ . So, the  $\mathfrak{A}(X)$ -coloring of  $L$  is just a commutative diagram in  $\mathfrak{A}(X)$  drawn on 2-skeleton of some triangulation of  $L$ . The concordance of two  $\mathfrak{A}(X)$ -colorings  $\xi_0, \xi_1$  of  $L$  is a coloring of the polyhedron  $L \times [0, 1]$ , which induces the coloring  $\xi_i$  on the  $i$ -th side. By abstract nonsense to prove (1) is the same as to establish functorial one-to-one correspondence between isomorphism classes of PL fiber-bundles on  $L$  with fiber  $X$  and concordance classes of  $\mathfrak{A}(X)$  colorings of  $L$ .

We will mention how we would like but cannot establish such a correspondence. This speculation is borrowed from [Ste86]. To any  $\mathfrak{A}(X)$ -coloring of  $L$  we can apply the construction  $\text{Hocolim}$ , and its geometric realization will produce a triangulated fiber bundle with fiber  $X$ . On the other side one can triangulate any fiber bundle with the base  $L$ . To any triangulated fiber bundle  $J$  with base  $L$  and fiber  $X$  one can canonically associate ([Hat75],[Ste86]) some  $\mathfrak{A}(X)$ -coloring of the first barycentric subdivision of the base of  $J$ . We call this construction by  $\text{Hocolim}^{-1}$ .

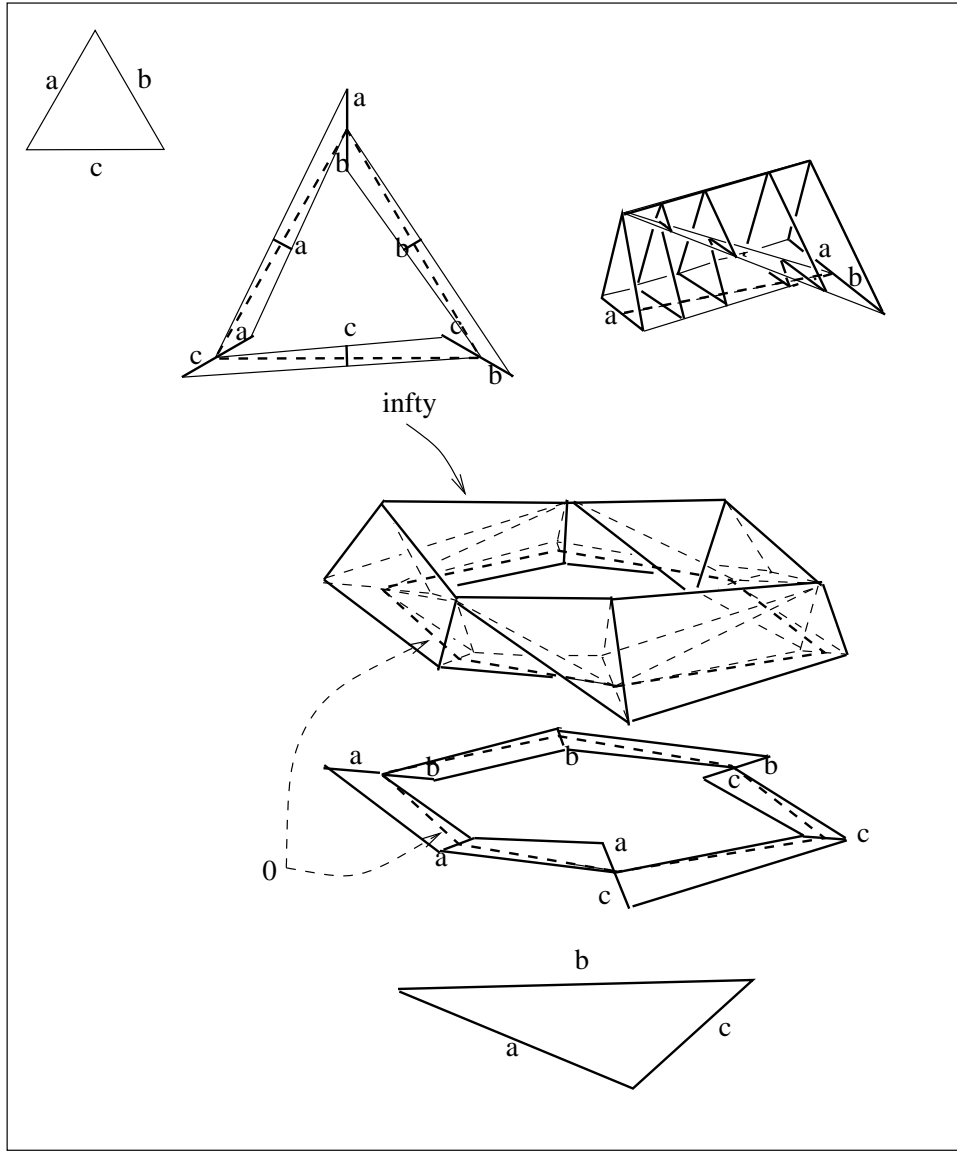
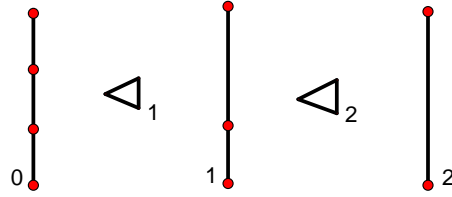

FIGURE 4. The cellular  $(S^1, 0, \infty)$  model of the tangent bundle of a triangle

The composition  $\text{Hocolim} \circ \text{Hocolim}^{-1}$  applied to a bundle produces an isomorphic bundle. We would prove (1) in a nice and short way if we could establish some canonical concordance between any  $\mathfrak{R}(X)$ -coloring  $\xi$  of  $L$  and the coloring  $\text{Hocolim}^{-1}\text{Hocolim}\xi$ . This would magically eliminate geometry. Unfortunately there is no way to see such a canonical concordance. This is the cause of some published



FIGURE 5.



and many unpublished mistakes. From the theory developed in [Mnë] it follows that  $\xi$  and  $\text{Hocolim}^{-1}\text{Hocolm} \xi$  are concordant, but the concordance is transcendental.

Instead of using  $\text{Hocolim}$ -construction we are constructing a bundle on  $L$  from  $\mathfrak{R}(X)$ -coloring of  $L$  using traditional construction of trivializations and structure homeomorphisms. Let  $K$  be a  $\mathfrak{R}(X)$ -colored simplicial complex,  $|K| = L$ . The coloring induces coloring of a  $k$ -simplex of  $K$  by the chain

$$Q_0 \rightsquigarrow Q_1 \rightsquigarrow \dots \rightsquigarrow Q_k$$

of abstract aggregations. According to speculations in §0.4 on page 5 one can realize this chain by the chain

$$Q = (Q_0 \trianglelefteq Q_1 \trianglelefteq \dots \trianglelefteq Q_k)$$

of geometric aggregations of geometric PL-ball complexes. With the chain  $Q$  one can associate a ball decomposition of the trivial bundle  $X \times \Delta^k \xrightarrow{\pi} \Delta^k$  into the horizontal “prisms” which are the trivial subbundles with a ball as a fiber. The drawings 5 and 6 illustrate the construction of prismatic decomposition on  $\pi$  by the chain of geometric aggregations. The combinatorics of the coloring associates to any pair of simplices  $s_0 \subset s_1$  in  $K$  a combinatorial isomorphism of two prismatic structures on trivial bundle over  $s$ . By Alexander’s trick one can represent all these combinatorial isomorphisms by fiberwise structure PL-homeomorphisms of fiber bundle with the base  $L$  and the fiber  $X$ . All these structure homeomorphisms map prisms to prisms. As a result we obtained from  $\mathfrak{R}(X)$ -colorings the class of fiber bundles with unusual structure homeomorphisms – the “prismatic” ones.

In this setup the inverse problem is to learn how to deform the structure homeomorphisms of arbitrary PL fiber bundle into the “prismatic” form and present a consistent coloring in a controllable way.

At this point it is useful to recall the proof of the Lemma on fragmentation of isotopy. This Lemma was proved by Hudson [Hud69] in the PL case. It states

FIGURE 6.

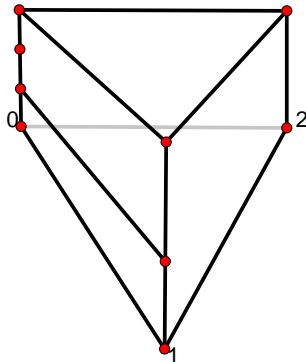

that for any covering  $U = \{U_i\}_i$  of a manifold  $X$  by open balls and for any PL-homeomorphism  $X \xrightarrow{f} X$  which is isotopic to identity there exist a finite decomposition  $f = f_1 \circ \dots \circ f_m$  such that  $\forall i \exists j : \text{supp } f_i \subset U_j$ . The proof of the fragmentation lemma contains more information than the statement. In the proof we pick arbitrary PL-isotopy  $F$  connecting  $f$  and identity. Then we deform  $F$  in the class of isotopies with fixed ends to the isotopy  $F'$  of a special form. The isotopy  $F'$  corresponds to the chain of isotopies which are fixed on complements of open balls from  $U$ .

The isotopy  $F$  is the same thing as a fiberwise homeomorphism

$$X \times [0, 1] \xrightarrow{F} X \times [0, 1]$$

commuting with the projection on  $[0, 1]$  and such that  $F_0 = \text{id}$  and  $F_1 = f$ . The homeomorphism  $F$  is the same thing as a one-dimensional foliation  $\mathcal{F}$  on  $X \times [0, 1]$  transversal to the fibers of the projection. (Figure 7). The homeomorphism  $F'$  corresponds to foliation  $\mathcal{F}'$  with following property: for any point  $b \in [0, 1]$  all the points  $x \in X$  such that the leaf of  $\mathcal{F}$  “is not horizontal” at  $(x, b)$  are contained in an element of  $U$  (Figure 8). Inspecting the drawing of  $\mathcal{F}'$  one can see that it is possible to subdivide the base  $[0, 1]$  into the intervals  $u_1, \dots, u_m$  and introduce prismatic structure on all subbundles  $X \times u_i \xrightarrow{\pi_2} u_i$  such that induced homeomorphisms  $F'|_{u_i}$  are prismatic. So, the construction of the fragmentation lemma allows us to deform a fiberwise homeomorphism of the trivial bundle over interval into the system of prismatic homeomorphisms over the subdivision of interval. The deformation  $F \rightsquigarrow F'$  has a canonical form and possesses a coordinate generalization to the homeomorphisms of the trivial bundle over cube. So, realizing the program of such a

FIGURE 7.

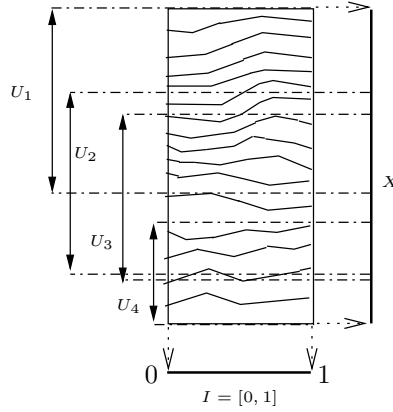
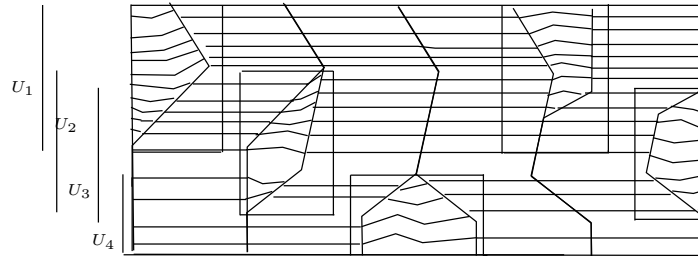

FIGURE 8.



generalization together with the development of appropriate surgery for fiberwise homeomorphisms consumes about 100 pages in [Mnë].

#### REFERENCES

- [Bjö84] A. Björner. Posets, regular CW complexes and Bruhat order. *European J. Combin.*, 5(1):7–16, 1984.
- [Bjö95] A. Björner. Topological methods. In *Handbook of combinatorics, Vol. 1, 2*, pages 1819–1872. Elsevier, Amsterdam, 1995.
- [GJ99] Paul G. Goerss and John F. Jardine. *Simplicial homotopy theory*, volume 174 of *Progress in Mathematics*. Birkhäuser Verlag, Basel, 1999.
- [Hat75] A. E. Hatcher. Higher simple homotopy theory. *Ann. of Math. (2)*, 102(1):101–137, 1975.
- [Hud69] J. F. P. Hudson. *Piecewise linear topology*. University of Chicago Lecture Notes prepared with the assistance of J. L. Shaneson and J. Lees. W. A. Benjamin, Inc., New York–Amsterdam, 1969.

- [KL66a] N. H. Kuiper and R. K. Lashof. Microbundles and bundles. I. Elementary theory. *Invent. Math.*, 1:1–17, 1966.
- [KL66b] N. H. Kuiper and R. K. Lashof. Microbundles and bundles. II. Semisimplicial theory. *Invent. Math.*, 1:243–259, 1966.
- [Lev89] Norman Levitt. *Grassmannians and Gauss maps in piecewise-linear topology*, volume 1366 of *Lecture Notes in Mathematics*. Springer-Verlag, Berlin, 1989.
- [Mac78] Robert MacPherson. The combinatorial formula of Gabrielov, Gel'fand and Losik for the first Pontrjagin class. In *Séminaire Bourbaki, 29e année (1976/77)*, volume 677 of *Lecture Notes in Math.*, pages Exp. No. 497, pp. 105–124. Springer, Berlin, 1978.
- [Mac93] Robert MacPherson. Combinatorial differential manifolds. In *Topological methods in modern mathematics (Stony Brook, NY, 1991)*, pages 203–221. Publish or Perish, Houston, TX, 1993.
- [May75] J. Peter May. Classifying spaces and fibrations. *Mem. Amer. Math. Soc.*, 1(1, 155):xiii+98, 1975.
- [Mil61] J Milnor. *Microbundles and differential structures*. (Mimeographed notes) Princeton University, September 1961.
- [Mnë] Nikolai Mnëv. Combinatorial fiber bundles and fragmentation of PL fiberwise homeomorphism. *Zapiski Nauchnyh Seminarov POMI*, v344, p 56-173, 2007 (Russian) arXiv:0708.4039 [math.GT]
- [MZ93] Nicolai E. Mnëv and Günter M. Ziegler. Combinatorial models for the finite-dimensional Grassmannians. *Discrete Comput. Geom.*, 10(3):241–250, 1993.
- [Ste86] Mark Steinberger. The classification of PL fibrations. *Michigan Math. J.*, 33(1):11–26, 1986.
- [Whi39] J. H. C. Whietehhead. Simplicial spaces, nuclei and m-groups. *Proc. London Math. Soc.*, 45:243–327, 1939.