

Genus two Smale-Williams solenoid attractors in 3-manifolds

Jiming Ma and Bin Yu

May 3, 2019

Abstract: Using alternating Heegaard diagrams, we construct some 3-manifolds which admit diffeomorphisms such that the non-wandering sets of the diffeomorphisms are composed of Smale-Williams solenoid attractors and repellers, an interesting example is the truncated-cube space. In addition, we prove that if the nonwandering set of the diffeomorphism consists of genus two Smale-Williams solenoids, then the Heegaard genus of the closed manifold is at most two.

Keywords: 3-manifolds, Smale-Williams solenoid attractors, alternating Heegaard diagram.

MR(2000)Subject Classification: 57N10, 58K05, 37E99, 37D45.

1. Introduction

For a diffeomorphism of a manifold $f : M \rightarrow M$, Smale introduced the notion of hyperbolic structure on the non-wandering set, $\Omega(f)$, of f . It is Smale's long range program to classify a Baire set of these diffeomorphisms, and $\Omega(f)$ plays a crucial role in this program. He also introduced solenoid into dynamics in [S], in the literature this solenoid is called Smale solenoid or pure solenoid.

To carry out this program, Williams defined 1-dimensional solenoid in terms of 1-dimensional branched manifold, which is the generalization of Smale solenoid. There are two methods to define Smale-Williams solenoid: the inverse limit of an expanding map on branched manifold or the nested intersections of handlebodies.

Bothe studied the ambient structure of attractors in [B1], through this work, we can see the two definitions above are equivalent. Boju Jiang, Yi Ni and Shicheng Wang studied the global question in [JNW]. The question is, if a closed 3-manifold admit a diffeomorphism f such that the non-wandering set of f consists of two Smale solenoids, what we can say about the manifold

M . They proved that the manifold must be a lens space. Furthermore, for any lens space, they can construct such a diffeomorphism. Our previous paper [MY] also considered this question, we got all Smale solenoids realized in a given lens space through an inductive construction. Actually, part work of [JNW] and [MY] have been studied in [B2].

A manifold M admitting a diffeomorphism f such that $\Omega(f)$ consists of two hyperbolic attractors presents a symmetry of the manifold with certain stability. In the paper [JNW], the authors noted that they believe many more 3-manifolds admit such symmetry if we replace the Smale solenoid by its generalization—Smale-Williams solenoid.

In this paper we consider this question, more precisely, we have the following problem: is there any closed orientable three manifold M which admits a diffeomorphism f such that the non-wandering set of f , $\Omega(f)$, is composed of Smale-Williams solenoid attractors and repellers?

In fact, for any 3-manifolds M , there is a diffeomorphism f such that (M, f) has a Smale-Williams solenoid as one attractor, so in the question, we must require that all of $\Omega(f)$ consists of Smale-Williams solenoids, and using standard arguments in dynamics, in this case, there is exactly one attractor and one repeller.

Gibbons studied this question in S^3 in [G]. He constructed many such diffeomorphisms on S^3 . Similar with the discussion in [JNW], we focus on the question that which manifold admit such a diffeomorphism. The main results of this paper are the following

Theorem 3.4: *Let M be a closed 3-manifold, and there is $f \in \text{Diff}(M)$ such that $\Omega(f)$ consists of genus two Smale-Williams solenoids, then the Heegaard genus of M , $g(M) \leq 2$.*

Theorem 4.5: *If a Heegaard splitting $M = N_1 \cup N_2$ of the closed orientable 3-manifolds M is a genus two alternating Heegaard splitting, then there is a diffeomorphism f , such that $\Omega(f)$ consists of two Smale-Williams solenoids.*

In fact, we give the first example that genus two Smale-Williams solenoids can be realized globally in a Heegaard genus two closed 3-manifold. An interesting example is the rational homology sphere whose fundamental group is the extended triangle group of order 48, i.e, the truncated-cube space, see [M].

Some notions in 3-dimensional manifolds theory and in dynamics will be given in Section 2, for the definition of alternating Heegaard splitting, see Section 4.

2. Notions and facts in 3-dimensional manifolds theory and in dynamics

For fundamental facts about 3-manifolds see [H] and [J]. Let G be a finite graph in R^3 , then a regular neighborhood H of G in R^3 is called a *handlebody*, it is a 3-manifold with boundary, the genus of its boundary is called the genus of H , denoted by $g(H)$. Let M be a closed orientable 3-manifold, if there is a closed orientable surface S in M which separates M into two handlebodies H_1 and H_2 , then we say $M = H_1 \cup_S H_2$ is a *Heegaard splitting* of M , S is called a *Heegaard surface*. Any closed orientable 3-manifold has infinitely many Heegaard splittings, and the minimum of the genus of the Heegaard surfaces is called the Heegaard genus of the 3-manifold M .

A properly embedded 2-sided surface F in a 3-manifold M is called an *incompressible surface* if it is π_1 -injective, otherwise, it is a compressible surface.

The following theorems will be used in the paper:

Haken Finiteness Theorem. *Let M be a compact orientable 3-manifold. Then the maximum number of pairwise disjoint, non-parallel closed connected incompressible surfaces in M , denoted by $h(M)$, is a finite integer ≥ 0 .*

Papakyriakopoulos Loop Theorem. *Let M be a compact orientable 3-manifold and $S \subset M$ a closed orientable surface. If the homomorphism $i_* : \pi_1(S) \rightarrow \pi_1(M)$ induced by the embedding $i : S \rightarrow M$ is not injective, then there is an embedded disk $D \subset M$ such that $D \cap S = \partial D$ and ∂D is an essential circle in S .*

We recall some facts about Smale-Williams solenoid from the famous paper [W1].

Definition 2.1: A *branched 1-manifold* L , is just like a smooth 1-manifold, but there are two type of coordinate neighborhoods are allowed. These are the real line R and $Y = \{(x, y) \in R^2 : y = 0 \text{ or } y = \varphi(x)\}$. Here $\varphi : R \rightarrow R$ is a fixed C^∞ function such that $\varphi(x) = 0$ for $x \leq 0$ and $\varphi(x) > 0$ for $x > 0$. The *branch set* B , of L , is the set of all points of L corresponding to $(0, 0) \in Y$.

The first Betti number $\beta_1(L)$ is called the *genus* of the branched 1-manifold, and which is just the genus of the handlebody that L induced(See Example 2.6).

Note that a branched 1-manifold L has a tangent bundle $T(L)$, and a differentiable map $f : L \rightarrow L'$ between branched 1-manifolds induces a map $Df : T(L) \rightarrow T(L')$ of their tangent bundles.

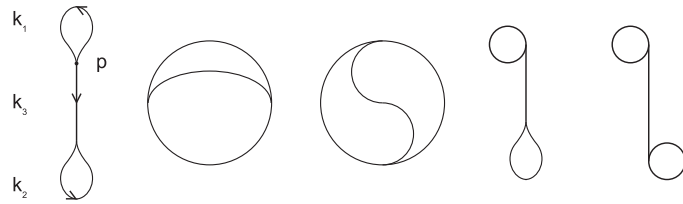

Figure 1

Definition 2.2: Let L be a branched 1-manifold, a C^r immersion $g : L \rightarrow L$ is called an *expansion map*, if there are $c > 0, \lambda > 1$, such that

$$\|(Dg)^n(v)\| \geq c\lambda^n \|v\|$$

$\forall n \in \mathbb{N}, \forall v \in T(L)$.

Definition 2.3: Let L be a branched 1-manifold with branch set B . We call $g : L \rightarrow L$ a *Williams expansion map*, if:

- Axiom 1. g is an expansion map;
- Axiom 2. $\Omega(g) = L$;
- Axiom 3. Any point p of L has a neighborhood $U(p)$, such that $g(U(p))$ is an arc;
- Axiom 4. There is a finite set $A \subset L$, such that, $g(A \cup B) \subset A$.

Definition 2.4: Let Σ be the inverse limit of the sequence

$$L \xleftarrow{g} L \xleftarrow{g} L \xleftarrow{g} \dots$$

where L is a branched 1-manifold, g is a Williams expansion map on L . For a point $a=(a_0, a_1, a_2, \dots) \in \Sigma$, let $h^{-1}(a) = (a_1, a_2, a_3, \dots)$, then $h : \Sigma \rightarrow \Sigma$ is a homeomorphism. Σ is called the *Smale-*

Williams solenoid with *shift map* h , denoted it by (Σ, h) .

Example 2.5: See [W1], Figure 1 contains all of the branched 1-manifolds with two branched points. Only the first two allow immersions satisfying Axiom 2. Let K be the first one and define the Williams expansion map $g : K \rightarrow K$ on its oriented 1-cells by:

$$K_1 \longrightarrow K_3^{-1}K_1K_3$$

$$K_2 \longrightarrow K_3K_2K_3^{-1}$$

$$K_3 \longrightarrow K_2K_3^{-1}K_1$$

It is easy to check that g satisfies Axiom 1, 3, 4 of Definition 2.3. For Axiom 2, for some semi-conjugacy reason we only need to check that the induced symbolic dynamical system matrix X is irreducible, that is, for all $1 \leq i, j \leq \dim(X)$, there exists $N(i, j) > 0$ such that the ij^{th} entry of $X^{N(i, j)}$ is positive, see [BH]. The induced matrix X of g is

$$\mathbf{X} = \begin{pmatrix} 1 & 0 & 2 \\ 0 & 1 & 2 \\ 1 & 1 & 1 \end{pmatrix}$$

obviously X is irreducible.

Example 2.6: Figure 2(a) contains a genus two handlebody N with disk foliation and a self embedding f . In fact, we take N as a "neighborhood" of K , and there is a natural projection π from N to K , and the embedding f is induced by g in Example 2.5. We define $\Lambda = \bigcap_{n=1}^{\infty} f^n(N)$, then (Λ, f) is conjugate to (Σ, h) via T constructed below. We have the following commutative diagram,

$$\begin{array}{ccc} N & \xrightarrow{f} & N \\ \downarrow \pi & & \downarrow \pi \\ K & \xrightarrow{g} & K \end{array}$$

$\forall x \in \Lambda$, $T(x)$ is defined to be $(\pi(x), \pi(f^{-1}(x)), \dots, \pi(f^{-n}(x)), \dots)$. As we shall see in Proposition 2.7, T is the conjugate map.

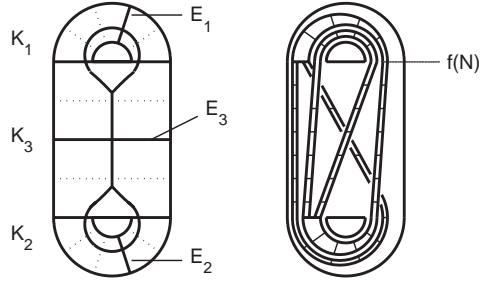

Figure 2(a)

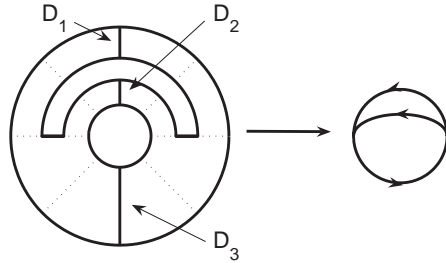

Figure 2(b)

Example 2.6 shows the way to construct Smale-Williams solenoid locally in a geometrical way, the key is to deal with the branched points, we can get the following proposition:

Proposition 2.7: *Let L be a branched 1-manifold with Williams expansion map g which induces Smale-Williams solenoid Σ and shift map h . Then the dynamical system (Σ, h) has local three dimensional model (Λ, f) , this means, there is a genus $\beta_1(L)$ handlebody N , an embedding $f : N \hookrightarrow N$, such that*

(1) *There is a projection map $\pi : N \rightarrow L$ which gives a disc foliation structure of N by $\pi^{-1}(p)$, $\forall p \in L$. f preserves the foliation structure, furthermore, the area satisfies*

$$S_{f(\pi^{-1}(p))} / S_{\pi^{-1}(p)} \leq \epsilon$$

for some $\epsilon > 0$ small enough.

(2) Define $\Lambda = \bigcap_{n=1}^{\infty} f^n(N)$, we still call $f|_{\Lambda}$ f , such that, (Σ, h) is conjugate to (Λ, f) .

Proof: This proof is based on the Example 2.6.

1. Construct (N, π, f) .

Step a. Take a "neighborhood" of L , which is a handlebody N , and we foliated N by disks as in Figure 2(a), so there is a natural projection $\pi : N \rightarrow L$.

Step b. Obviously there is a local immersion map $i : L \rightarrow N$ such that $\pi \circ i = g$. Because of $\dim(N) = 3 = 2\dim(L) + 1$, we can disturb $i(L)$ in N such that we get an embedding map $i_1 : L \hookrightarrow N$ such that $\pi \circ i_1 = g$. Now we take a neighborhood of $i_1(L)$, say N_1 , such that N_1 is embedded into N . Just like step a, it is easy to get an embedding map $f : N \hookrightarrow N$ such that, $f(N) = N_1$ and satisfies condition (1) of Proposition 2.7.

2. Conjugation.

Let Σ be the Smale-Williams solenoid defined by (L, g) , and h is the shift map. Define $T : \Lambda \rightarrow \Sigma, \forall x \in \Lambda, T(x) = (\pi(x), \pi(f^{-1}(x)), \dots, \pi(f^{-n}(x)), \dots)$. Now it is easy to check that $T \circ f = h \circ T$, $T \circ f(x) = (\pi \circ f(x), \pi(x), \pi(f^{-1}(x)), \dots)$, $h \circ T(x) = (g \circ \pi(x), \pi(x), \pi(f^{-1}(x)), \dots)$. Since $\pi \circ f = g \circ \pi$, we get $T \circ f = h \circ T$. On the other hand, T has inverse map $T^{-1} : (x_0, x_1, x_2, \dots) \rightarrow \pi^{-1}(x_0) \cap f(\pi^{-1}(x_1)) \cap f(\pi^{-2}(x_2)) \cap \dots$, this map is well-defined by $S_{f(\pi^{-1}(p))}/S_{\pi^{-1}(p)} \leq \epsilon$, it is easy to check it is the inverse map of T . So (Σ, h) is conjugate to (Λ, f) by T^{-1} . Obviously, (N, f) constructed above is an attractor model. Q.E.D.

This type of attractors have important meaning in the study of attractors, see Williams [W2].

3. Restriction on the Heegaard genus

We term the first two branched 1-manifolds *type I* and *type II* respectively, and discuss their Williams expansion map using their geometrical model introduced above. We call this type of attractor *type I(type II) Smale-Williams solenoid attractor*.

Definition 3.1: Let N be a genus two handlebody in a 3-manifold M , if there is $f \in \text{Diff}(M)$ such that $f|_N$ is conjugate to a local model of type I(type II) Smale-Williams solenoid attractor,

then we call (M, f) has *type I (type II) Smale-Williams solenoid attractor*.

Lemma 3.2: *Let (N, f) be a local model of a genus two Smale-Williams solenoid attractor, then there is no properly embedded disk D in N such that $f(N) \cap D = \emptyset$.*

Proof: We prove the lemma only for type I Smale-Williams solenoid attractor, and the proof for the case of type II is similar.

If there is an essential disk D such that $f(N) \cap D = \emptyset$, then there is a solid torus $V \subset N$ such that $Im(f) \subset V$, this induces $Im(f_*) \subset \pi_1(V) \cong \mathbf{Z}$, so $Im(f_*)$ is abelian.

Let K be a type I branched 1-manifold as Figure 1 shows and g be the induced map of f on K , which is a train track map, see [BH].

We choose a base point P for $\pi_1(K)$, $x = [K_1]$, $y = [K_3K_2K_3^{-1}]$, $\pi_1(K) = \langle x \rangle * \langle y \rangle$ is a free group of rank two (see Figure 1). Since $Im(g_*)$ is an abelian group, we have that $g_*(xyx^{-1}y^{-1}) = 1$. $xyx^{-1}y^{-1} = [K_1K_3K_2K_3^{-1}K_1^{-1}K_3K_2^{-1}K_3^{-1}]$. Since $K_1K_3K_2K_3^{-1}K_1^{-1}K_3K_2^{-1}K_3^{-1}$ is a legal path in K and g is a train track map, we have $g(K_1K_3K_2K_3^{-1}K_1^{-1}K_3K_2^{-1}K_3^{-1})$ is also a legal path, so it can not be a homotopic trivial path in K (See [BH]). This means $g_*(xyx^{-1}y^{-1}) \neq 1$, it is a contradiction. Q.E.D.

Proposition 3.3: *Let M be a closed 3-manifold, and N is a genus two handlebody in M . If there is $f \in Diff(M)$ such that $(N, f|_N)$ is conjugate to a local genus two Smale-Williams solenoid, then ∂N is compressible in $\overline{M - N}$.*

Proof: Suppose ∂N is incompressible in $\overline{M - N}$. Let m be the Haken number of $\overline{M - N}$, denoted by $h(\overline{M - N}) = m$, $S_1, S_2, \dots, S_{m-1}, \partial N$ are mutually disjoint nonparallel incompressible surfaces in $\overline{M - N}$. Since f is a diffeomorphism from $\overline{M - N}$ to $\overline{M - f(N)}$, so $h(\overline{M - f(N)}) = m$, and $\partial f(N)$ is incompressible in $\overline{M - f(N)}$. If ∂N is compressible in $\overline{M - f(N)}$, then ∂N is compressible in $\overline{N - f(N)}$, which contradicts to Lemma 3.2. Then, by standard arguments in 3-manifold topology, S_1, S_2, \dots, S_{m-1} are incompressible surfaces in $\overline{M - f(N)}$. And then, $S_1, S_2, \dots, S_{m-1}, \partial N, \partial f(N)$ are mutually disjoint nonparallel incompressible surfaces in $\overline{M - f(N)}$, so $h(\overline{M - f(N)}) \geq m + 1$, which contradicts to $h(\overline{M - f(N)}) = m$. Q.E.D.

Theorem 3.4: *Let M be a closed 3-manifold, and there is $f \in \text{Diff}(M)$ such that $\Omega(f)$ consists of genus two Smale-Williams solenoids, then the Heegaard genus of M , $g(M) \leq 2$.*

Proof: If the nonwandering set $\Omega(f)$ consists of genus two Smale-Williams solenoids, then standard arguments in dynamics theory shows $\Omega(f) = \Lambda_1 \sqcup \Lambda_2$ where Λ_1 is an attractor, Λ_2 is a repeller (See [JNW]). In addition, $\Lambda_1(\Lambda_2)$ is realized by genus two handlebody $N_1(N_2) \subset M$, $\Lambda_1 = \bigcap_{n \geq 0} f^n(N_1)$ and $\Lambda_2 = \bigcap_{n \leq 0} f^n(N_2)$. There are $m, k \in \mathbb{Z}^+$, such that $\partial f^m(N_2) \subset \overline{N_1 - f^k(N_1)} \subset N_1$, so if necessary, we let $f^m(N_2)$ be the new N_2 , then we have $\partial N_2 \subset \overline{N_1 - f^k(N_1)} \subset N_1$. By Proposition 3.3, ∂N_2 is compressible in $\overline{M - N_2} = \overline{N_1 - N_2}$. Let c be an essential simple closed curve in ∂N_2 which bounds a disk D in $\overline{N_1 - N_2}$. Adding a neighborhood of D in $N_1 - N_2$ to N_2 (2-handle addition along c), and denote the resulting manifold by N_2^* :

Case 1. If c is non-separating in ∂N_2 , $\partial N_2^* = S$ is a torus. In this case N_1 is divided into two parts W_1 and W_2 by S , $\partial W_2 = S \sqcup \partial N_1$ and $\partial W_1 = S$:

Subcase 1.1. S is compressible in W_1 , so W_1 is a solid torus, and $\overline{N_1 - N_2}$ is a genus two handlebody. Hence $g(M) \leq 2$.

Subcase 1.2. S is incompressible in W_1 , since N_1 is a handlebody, S must be compressible in W_2 . Compressing S in W_2 , we get a 2-sphere P in W_2 , so P is also in N_2^* . P separates W_2 into A and B , where $S \subset \partial A$ and $\partial N_1 \subset \partial B$. And we have $N_2^* = A^* \natural B^*$, where A^* is obtained from A by capping off P , and B^* is obtained from $B \cup \overline{N_2 - N_1}$ by capping off P . $W_1 \cup A$ is in the handlebody N_1 , so $W_1 \cup A$ is a 3-ball, $\pi_1(A^*)$ is nontrivial. And the rank of $\pi_1(N_2^*)$ is at most two, we get that the rank of $\pi_1(B^*)$ is at most one. So B^* has a genus one Heegaard splitting by the fact that the Heegaard genus of N_2^* is at most two. So $M = B^*$ has Heegaard genus at most one.

Case 2. If c is separating in ∂N_2 , $\partial N_2^* = S$ is composed of two tori S_1 and S_2 , so there are two manifolds W_1 and W_2 in $\overline{N_1 - N_2}$ with $\partial W_i = S_i$:

Subcase 2.1. One of W_1 and W_2 is a solid torus. Then there is a nonseparating simple closed curve in ∂N_2 which bound a disk in $\overline{N_1 - N_2}$, and turn to Case 1.

Subcase 2.2. S_i is incompressible in W_i , so S_i must be compressible in $\overline{N_1 - W_i}$. Let E be a compressible disk of S_1 in $\overline{N_1 - W_1}$, we can assume $E \cap D = \emptyset$, $E \cap S_2$ is a set of simple closed

curves, and $|E \cap S_2|$ is minimal along all such compressible disk of S_1 . If $E \cap S_2 \neq \emptyset$, take an innermost disk, say Δ , of E , which is a compressible disk of S_2 in $\overline{N_1 - W_2}$, which is also disjoint from D . Compressing S_2 along Δ , we get a 2-sphere P_2 , which bounds a 3-ball B_2 in N_1 , and $W_2 \subset B_2$. From this 3-ball, and the compressibility of S_1 in $\overline{N_1 - W_1}$, we can get a 3-ball B_1 , which is disjoint from D and B_2 , and contains W_1 , $\partial B_1 = P_1$. Connecting P_1 and P_2 by D , we get a separating 2-sphere P in $\overline{N_1 \cap N_2}$, which separates M into two components, each component is a B^3 since it is contained in a handlebody. So $M = S^3$. Q.E.D

4. Globally geometric realization of Smale-Williams solenoid type attractors in 3-manifolds

Definition 4.1: Let l_1, l_2 be two subarcs of a branched 1-manifold L , e an arc such that $e \cap (l_1 \cup l_2) = \partial e$, $E = I \times I = [-1, 1] \times [-1, 1]$ is a band with the core $\{0\} \times [-1, 1] = e$, $E \cap (l_1 \cup l_2) = [-1, 1] \times \{-1, 1\}$. Then along e , we get two new subarcs l_3, l_4 of a new branched 1-manifold L' , l_3 and l_4 has just one crossing, this process is said to be a *band move* along E . And note that there are two band moves along E , see Figure 3.

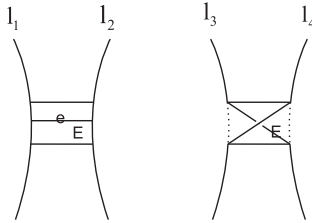

Figure 3

Definition 4.2(Alternating Heegaard splitting of type I): As in Figure 2(a), let N be a handlebody, K be a branched 1-manifold of type I, $\pi : N \rightarrow K$ be the natural projection, then there are three disks in N , say E_1, E_2 and E_3 , which separate N into two 3-balls, and E_3 is separating in N , the image of E_i in K_i is an interior point in K_i . Let c be a simple closed curve in ∂N , we say c is alternating with respect to (E_1, E_2, E_3) , if the intersection points of E_i occur in c alternatively about E_3 , that is, along c , we see $E_3, E_{i_1}, E_3, E_{i_2}, E_3, E_{i_3}, E_3, \dots$, where $i_j = 1$ or 2 and $i_j \cdot i_{j+1} = 2$ to all j .

Let $M = N_1 \cup N_2$ be a genus two Heegaard splitting, if there are three disks D_1, D_2, D_3 separate N_1 into two 3-ball, where D_3 is separating in N_1 , and there are three disks C_1, C_2, C_3 separate N_2 into two 3-ball, where C_3 is separating in N_2 , moreover ∂C_i is alternating with respect to (D_1, D_2, D_3) , and ∂D_i is alternating with respect to (C_1, C_2, C_3) , then we say the Heegaard splitting is *alternating of type I*.

Definition 4.3(Alternating Heegaard splitting of type II): As in Figure 2(b), let N be a handlebody, L be a branched 1-manifold of type II, $\pi : N \rightarrow L$ be the natural projection, then there are three disks in N , say E_1, E_2 and E_3 , which separate N into two 3-balls, none of E_i is separating in N , the image of E_i in L_i is an interior point in L_i . Let c be a simple closed curve in ∂N , we say c is alternating with respect to (E_1, E_2, E_3) , if the intersection points occur in c alternatively, that is, along c , we see $E_3, E_{i_1}, E_3, E_{i_2}, E_3, E_{i_3}, E_3, \dots$, where $i_j = 1$ or 2 .

Let $M = N_1 \cup N_2$ be a genus two Heegaard splitting, if there are three disks D_1, D_2, D_3 separate N_1 into two 3-balls, none of D_i is separating in N_1 , and there are three disks C_1, C_2, C_3 separate N_2 into two 3-balls, none of C_i is separating in N_2 . Moreover ∂C_i is alternating with respect to (D_1, D_2, D_3) , and ∂D_i is alternating with respect to (C_1, C_2, C_3) , then we say the Heegaard splitting is *alternating of type II*.

Proposition 4.3: *If there is a genus two handlebody N in M , and an alternating simple closed curve c in ∂N which bounds a disk in $\overline{M - N}$, then there is $f \in \text{Diff}(M)$, such that $\Omega(f)$ contains a genus two Smale-Williams solenoid attractor.*

Proof: The proof is an explicit construction, we construct the diffeomorphism in the type I case, the type II case is similar.

We choose three parallel curves c_1, c_2, c_3 in ∂N which are parallel to c . The branched 1-manifold J is a spine of N , which is composed of oriented 1-cells: J_1, J_2, J_3 as Figure 4 shows. Note that J induces a disk foliation of N , so $\pi : N \rightarrow J$ is the projection map. We do the following operations to J :

Operation 1. As indicated in Figure(4-1) \rightarrow Figure(4-2). We take a subarc $J_{1,1}$ of J_1 , half-twist and move it toward ∂N and identify it with a subarc $c_{1,1}$ of c_1 , just like Figure (4-2) shows, this process is a band move in Definition 4.1. Since c_1 bounds a disk in $\overline{M - N}$, we can push $c_{1,1}$ across

the disk to the arc of the subarc $c_{1,2}$, where $c_{1,2} = \overline{c_1 - c_{1,1}}$. We do the same surgeries to J_2, J_3 . In the end, we get a branched 1-manifold J^* which is isotopic to J in M .

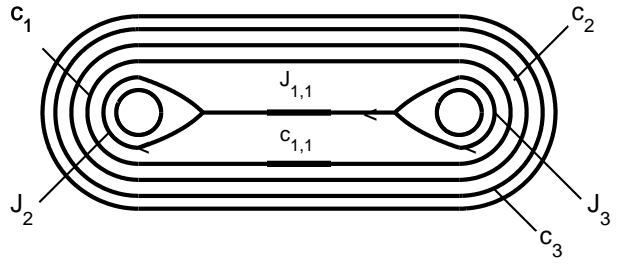

Figure 4-1

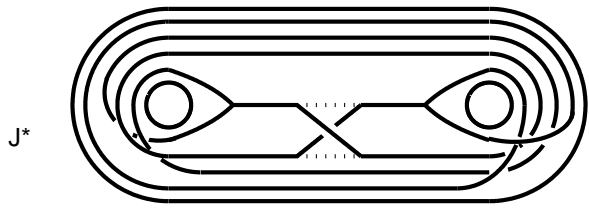

Figure 4-2

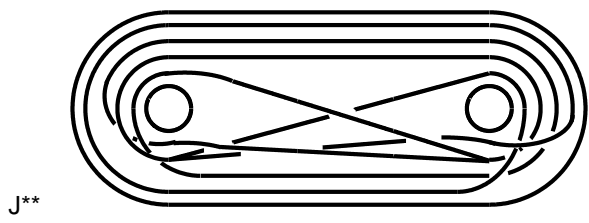

Figure 4-3

Figure 4

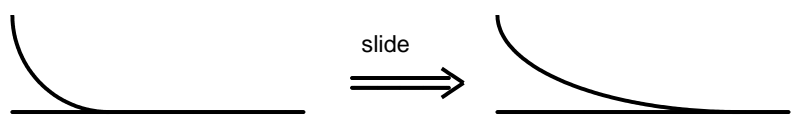

Figure 5

Operation 2. Note that the composite map $J \rightarrow J^* \rightarrow J$ is not a Williams expansion map, where $J^* \rightarrow J$ is induced by π . So as indicated in Figure(4-2) \rightarrow Figure(4-3). Slide one end of J_2^* along a subarc of J_1^* , also one end of J_3^* along another subarc of J_1^* , locally as Figure 5 shows. We get a new branched 1-manifold J^{**} which is isotopic to J in M obviously.

So we can choose an $f \in Diff(M)$ which is isotopic to the identity such that:

- (1) $f : N \hookrightarrow N$;
- (2) $f(J) = J^{**}$;

(3) f preserve the disk foliation structure of N . For every leaf D of the foliation, the area satisfies $S_{f(D)}/S_D \leq \epsilon$ for some $\epsilon > 0$ small enough.

(4) Let $g = \pi \circ f$, we get the following diagram,

$$\begin{array}{ccc} N & \xrightarrow{f} & N \\ \downarrow \pi & & \downarrow \pi \\ J & \xrightarrow{g} & J \end{array}$$

g is linear on every edge of J .

Claim: g is a Williams expansion map of J .

Proof of the Claim. We check Axiom 1, ... , Axiom 4 of Definition 2.3 one by one.

Axiom 1. From the construction of $f : N \rightarrow N$, for example in Figure 4, we know, $g: J_1 \rightarrow J_2 J_1^{-1} J_3$, $J_3 \rightarrow J_1^{-1} J_3 J_1 J_2 J_1^{-1} J_3$, and $J_2 \rightarrow J_1 J_2 J_1^{-1} J_3 J_1 J_2 J_1^{-1}$. Since f expands wholly and c has the alternating property then g is smooth immersion for every local smooth arc of J . Since there are two branched points, g is a Williams expansion map.

Axiom 2. Since the matrix of the symbol dynamical system induced by $g : J \rightarrow J$ is irreducible, actually nowhere is zero in the matrix through the check of Axiom 1. Thus any point of J is a nonwandering point of (J, g) .

Axiom 3 and Axiom 4. These are obviously. So the Claim follows.

By the Claim, we know $f \in Diff(M)$ and $\Omega(f)$ contains a genus two Smale-Williams solenoid attractor. Q.E.D.

Example 4.4(RP^3): Figure 6 is an alternating genus 2 Heegaard diagram of $M = RP^3 = N_1 \cup N_2$. The left figure depicts the diagram seen from out of N_1 , d_i bounds a disk D_i in N_1 , c_i bounds a disk C_i in N_2 . The right figure depicts the diagram seen from out of N_2 , it comes from the left diagram by Dehn twists $D_{e_3} D_{e_2} D_{e_2} D_{e_1}$ in Figure 7 and then follows by a mirror symmetry.

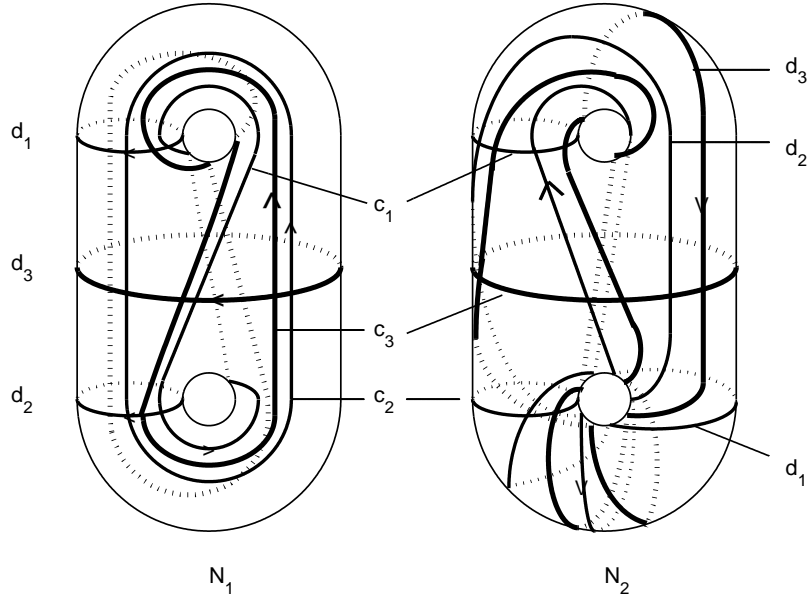

Figure 6

And now, by the diagram, we construct a self-diffeomorphism f of RP^3 such that $\Omega(f)$ consists of two type I Smale-Williams solenoids.

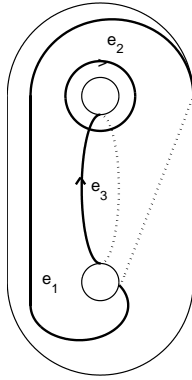

Figure 7

Let J be the natural spine of N_1 with respect to the three disks D_1, D_2 and D_3 bounded by d_1, d_2 and d_3 , and L be the spine of N_2 with respect to the three disks C_1, C_2 and C_3 bounded by c_1, c_2 and c_3 .

Let $J \cap D_i = P_i, L \cap C_i = O_i$ and we fix a point $Q_i \in c_i \cap d_i$. We connect P_i with Q_i by an arc v_i in D_i , and connect Q_i with O_i by an arc w_i in C_i .

We isotopy J to J^* in M by performing three band moves along v_1, v_2 and v_3 , similarly we can isotopy L to L^* by performing three band moves along w_1, w_2 and w_3 . By Figure 8, we can see that $L^* \sqcup J$ is isotopic to $J^* \sqcup L$: after three local half twist surgeries and pushing moves to $J^* \sqcup L$ (see Figure 8-2), we get $L^* \sqcup J$ (see Figure 8-3), all the surgery can be regarded as appearing in three mutually disjoint 3-balls $N(v_i \sqcup w_i)$ in M (see Figure 9), so this progress is an isotopy move, hence $L^* \sqcup J$ is isotopic to $J^* \sqcup L$. This process is similar with [JNW].

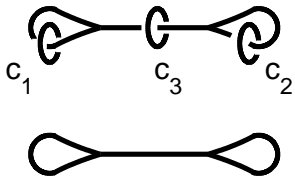

Figure 8-1

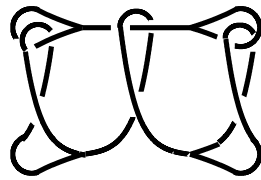

Figure 8-2

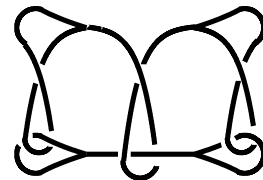

Figure 8-3

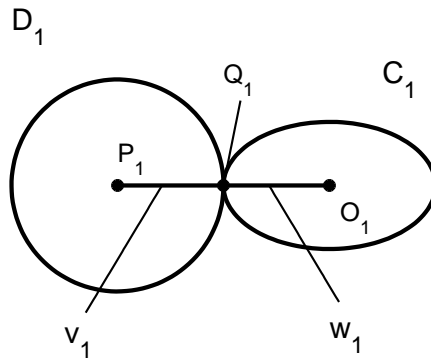

Figure 9

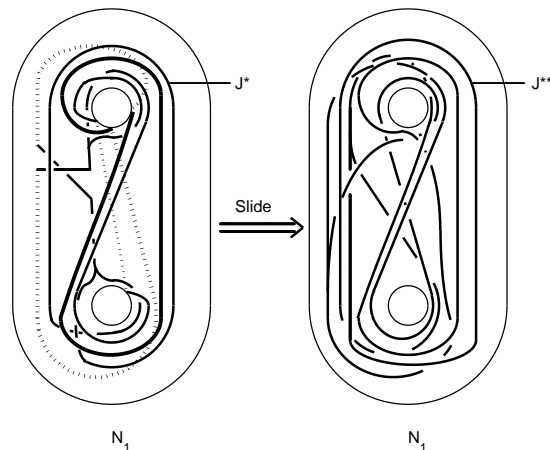

Figure 10

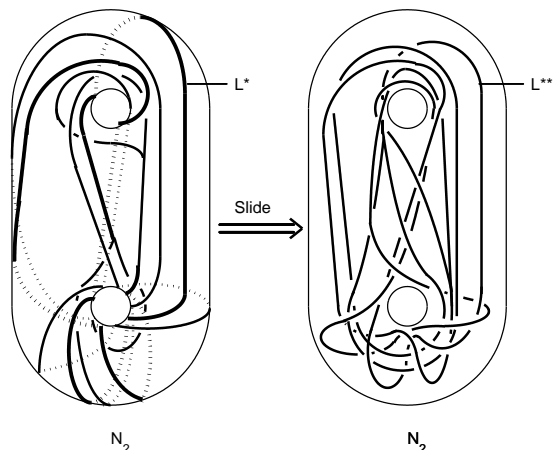

Figure 11

Now, we construct f . As Figures 10 and 11 show, we get J^{**} (L^{**}) from J^* (L^*) by slide operations. Since $J^{**} \sqcup L$ is isotopic to $L^{**} \sqcup J$ and as in the proof of Proposition 4.3, we can construct $f \in \text{Diff}(M)$ which is isotopic to identity, such that $f(J) = J^{**}$, $f(L^{**}) = L$ and $\Omega(f)$ is composed of type I Smale-Williams solenoids. Note that here the alternating condition is used to show that the induced matrix is irreducible, so Axiom 2 of Smale-Williams solenoid follows.

Theorem 4.5: *If a Heegaard splitting $M = N_1 \cup N_2$ of the closed orientable 3-manifolds M is a genus two alternating Heegaard splitting, then there is a diffeomorphism f , such that $\Omega(f)$ consists of two Smale-Williams solenoids.*

Proof: It is the same as Example 4.4. Q.E.D.

Example 4.6(The Truncated-Cube Space): Figure 12 is an alternating Heegaard diagram of a closed 3-manifold $M = N_1 \cup N_2$ see from outside of N_1 .

Its fundamental group, $\pi_1(M) = \langle x_1, x_2; x_1 x_2 x_1 x_2^{-1} x_1^{-1} x_2^{-1}, x_1 x_2 x_1^{-1} x_2 x_1 x_2^{-1} \rangle$. Let $a = x_2$ and $b = x_2 x_1$, we have $\pi_1(M) = \langle a, b; a^4 = b^3 = (ab)^2 \rangle$, it is the extended triangle group, $|\pi_1(M)| = 48$, so M is a genus two Seifert manifold with base surface S^2 and three singular fibers, M is called the truncated-cube space, see [M] and [T].

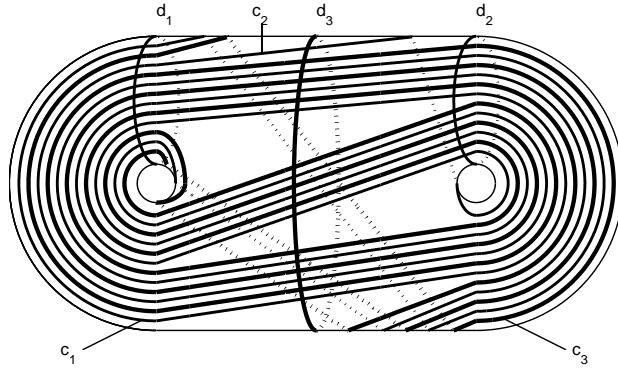

Figure 12

Example 4.7(S^3 with type II Smale-Williams solenoids): Figure 13 is an alternating Heegaard splitting of S^3 , so type II Smale-Williams solenoids can be realized in S^3 .

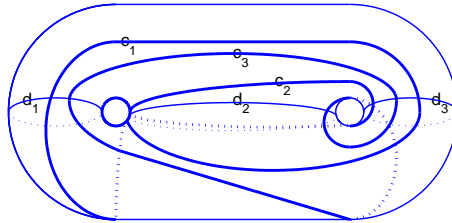

Figure 13

Acknowledgements: The authors would like to thank Professor Shicheng Wang for his many helpful discussions. Some of this work was completed while the first named author was a postdoctoral fellow at Peking University, and he thanks the department for its hospitality.

References.

[B1] H. G. Bothe, *The ambient structure of expanding attractors. I. Local triviality, tubular neighborhoods.* Math. Nachr. 107 (1982), 327-348.

- [B2] H. G. Bothe, *The ambient structure of expanding attractors. II. Solenoids in 3-manifolds*. Math. Nachr. 112 (1983), 69-102.
- [BH] M. Bestvita and M. Handel, *Train tracks and automorphisms of free groups*, Ann. of Math. 135(1992), 1-51.
- [G] J. C. Gibbons, *One-dimensional basic sets in the three-sphere*. Trans. Amer. Math. Soc. 164 (1972), 163–178.
- [H] J. Hempel, *3-Manifolds*, Ann. of Math. Studies, vol. 86, 1976.
- [J] W. Jaco, *Lectures on three-manifold Topology*, Published by Amer. Math. Soc. 1980.
- [JNW] Boju Jiang, Yi Ni and Shicheng Wang, *3-manifolds that admit knotted solenoids as attractors*, Trans. Amer. Math. Soc. 356, 4371-4382,(2004).
- [M] M. Montesinos, *Classical Tessellations and three-manifolds*, Springer-Verlag, 1985.
- [MY] Jiming Ma, and Bin Yu, *The realization of Smale solenoid type attractors in 3-manifolds*, Topology and its application,154(2007), no.17, 3021-3031.
- [S] S. Smale, *Differentiable dynamical systems*, Bull. Amer. Math. Soc. 73 (1967), 747-817.
- [T] C. B. Thomas, *Elliptic structures on 3-manifolds*, Cambridge University Press, 1986.
- [W1] R. F. Williams, *One-dimensional non-wandering sets*, Topology Vol.6, pp.473-487, (1967).
- [W2] R. F. Williams, *Expanding attractors*, Publ. Math. I. H. E. S. 43,169-203, (1974).
- School of Mathematical sciences, Fudan University, Shanghai 200433, P.R.China
 majiming@fudan.edu.cn
 Department of Mathematics, Tongji University, Shanghai 200092, P.R.China
 binyu1980@gmail.com

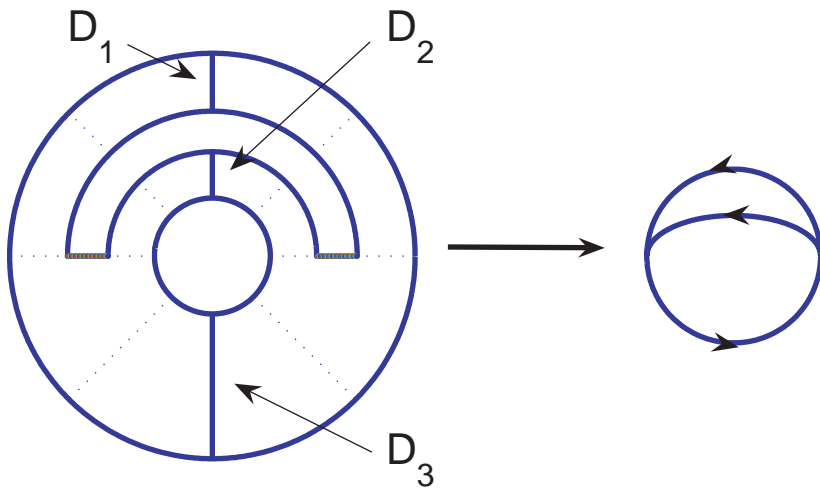
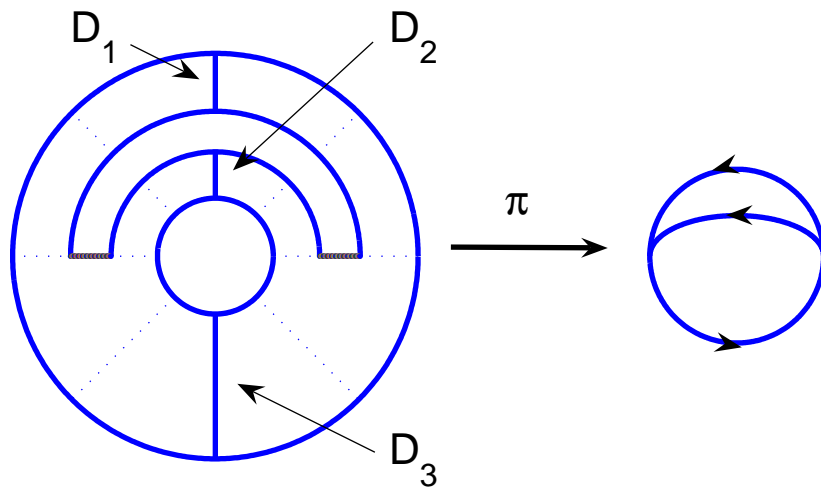

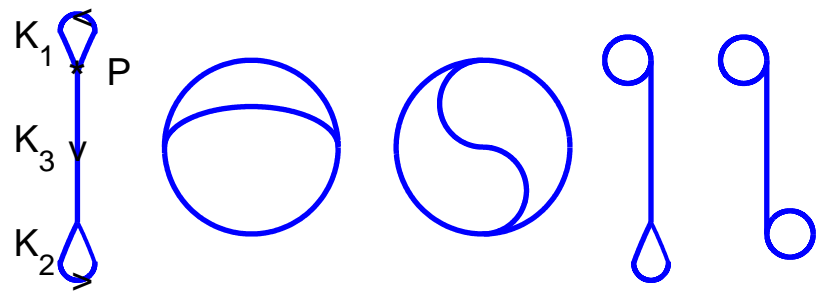

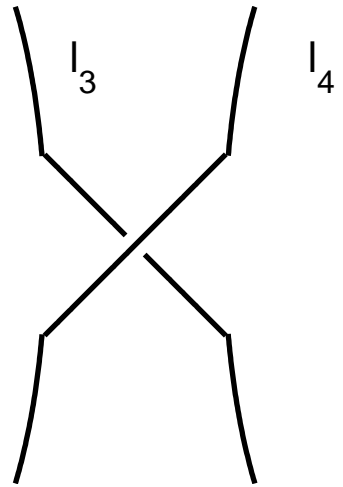
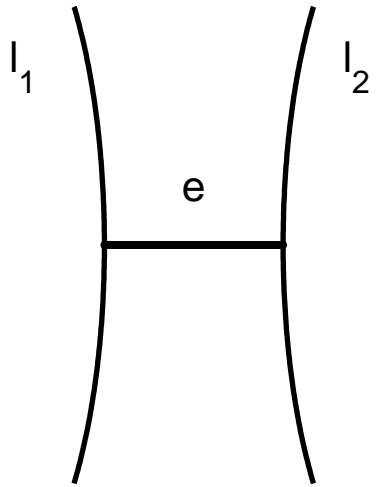

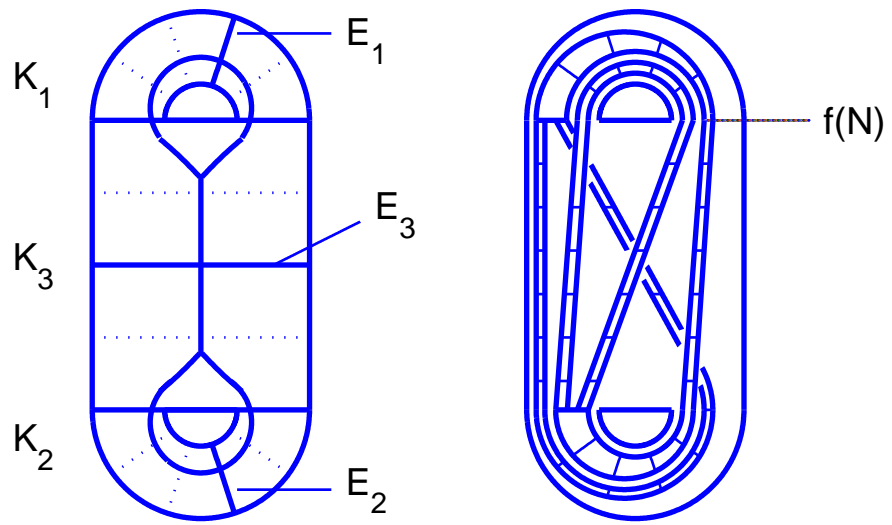

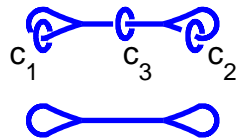

Figure 8-1

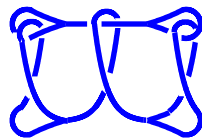

Figure 8-2

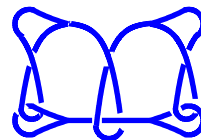

Figure 8-3

