

Towers of recollement and bases for diagram algebras: planar diagrams and a little beyond

Paul Martin*, R. M. Green[†] and Alison Parker[‡]

Abstract

The recollement approach to the representation theory of sequences of algebras is extended to pass basis information directly through the globalisation functor. The method is hence adapted to treat sequences that are not necessarily towers by inclusion, such as symplectic blob algebras (diagram algebra quotients of the type- \tilde{C} Hecke algebras).

By carefully reviewing the diagram algebra construction, we find a new set of functors interrelating module categories of ordinary blob algebras (diagram algebra quotients of the type- B Hecke algebras) at *different* values of the algebra parameters. We show that these functors generalise to determine the structure of symplectic blob algebras, and hence of certain two-boundary Temperley-Lieb algebras arising in Statistical Mechanics.

We identify the diagram basis with a cellular basis for each symplectic blob algebra, and prove that these algebras are quasihereditary over a field for almost all parameter choices, and generically semisimple. (That is, we give bases for all cell and standard modules.)

*Centre for Mathematical Science, City University, Northampton Square, London EC1V 0HB, UK

[†]Department of Mathematics, University of Colorado, Campus Box 395, Boulder, Colorado 80309-0395, USA

[‡]Department of Mathematics, University of Leicester, Leicester, LE1 7RH, UK

Contents

1	Introduction	3
1.1	Preliminary definitions	5
1.2	Summary of notations	8
2	Category theory preliminaries	9
2.1	Prestandard modules	9
2.2	Globalisation and balanced maps	10
2.3	Module bases under globalisation	12
3	Diagram algebras: initial examples	13
3.1	Brauer algebra wreaths	13
3.2	Periodic pair-partitions	16
3.3	Planar embeddings and contour algebras	17
3.4	Direct homomorphisms with known algebras	19
3.5	Diagram embeddings, subalgebras and deformations	20
4	The blob algebra b_n and the achiral algebra b'_n	21
4.1	Two-coloured diagrams	21
4.2	Subalgebras and deformations	22
4.3	The unfolding map μ	23
5	Recollement and b'_n representation theory	24
5.1	The b_n version	26
6	Symplectic blob algebras	27
6.1	Pseudodiagram categories	27
6.2	Initial pseudodiagram reduction	29
6.3	Towards finite and localisable algebras	30
6.4	Combinatorial localisation	31
6.5	Algebra localisation and the symplectic blob algebra	34
7	Affine symmetric TL algebra	36
7.1	On properties of the unfolding map μ^x	37
7.2	Periodic pseudodiagram reduction	38
8	Representation theory of ASTLA	41
8.1	General and generic results	41
8.2	Combinatorics of the basis B_{2m}^ϕ	43
8.3	Prestandard modules by G_e : Low rank examples	48
8.4	Top-half combinatorics	50
8.5	Restriction of prestandards to blob algebra standards	51
9	Discussion	54
A	Proof of Proposition 3.3.7	56
B	On constrained isotopy	57

1 Introduction

The idea of recollement [4] is applied to categories of modules in [10]. Iterated ‘towers’ of recollement are used in algebraic representation theory in [35] and formalised, for example, in [12]. (The *tower* here refers to the algebraic structure needed for statistical mechanics [35], although an elementary connection can be made in the semisimple case to Jones basic construction [17].)

If A is an algebra, and $e \in A$ an idempotent, then the category eAe -mod of left eAe -modules fully embeds in A -mod. At its most basic the idea is that if eAe -mod may be relatively simply analysed, the embedding then gives partial knowledge of A -mod. The standard tower picture has A as part of a tower of algebras by inclusion, such that eAe may be identified isomorphically with one of the subalgebras. The interplay of induction/restriction and globalisation/localisation functors facilitates representation theory in such a tower. This is the device discussed in [12].

All this would be of academic interest only, were it not for the ubiquity of such towers ‘in nature’. Transfer matrix algebras are algebras whose representation matrices build statistical mechanical transfer matrices [35]. The stability of the thermodynamic limit corresponds (to cut a long story short) to the existence of a tower of module-categorical embeddings. However [12] addresses only one way among many in which such a tower could occur.

A further limitation in the formalisation of [12] is that it concentrates on the abstract module category tower, and does not incorporate the tower of special module bases found in concrete examples (such as in [41, 38], and cf. [19]). This paper describes two ways in which the framework formalised in [12] may be extended, so as to treat the representation theory of a wider class of algebras. Firstly we integrate the module category tower framework with special algebra bases (as in diagram algebras, for example). This allows us to enumerate explicit bases for modules and algebras, rather than simply to generate structure theorems. Secondly we show that the framework is useful even when the tower is not (necessarily) a tower of inclusion. Indeed the control of basis compensates for the lack of induction and restriction functors, so the framework will work for algebra towers without induction and restriction. This latter is important for treating our motivating examples: families of algebras arising recently in the Physics of systems with special boundaries [14], which do not include (generalising the ordinary Temperley-Lieb algebras [53] and their immediate family, which do include [35]). We demonstrate the method by determining the structure of these algebras. (In the process we also introduce and make use of functors relating module categories for algebras differing by the choice of specialisation of a deformation parameter — certain choices of specialisation then being treatable together in ‘meta-categories’.)

One may deform the ordinary Temperley–Lieb diagram algebra by two-colouring the diagrams (seen as maps — see later) and assigning different parameters to shaded and unshaded loops. The result is isomorphic to the original. However deforming the B-type (left-right symmetric) subalgebra similarly constructs an algebra with a true extra parameter — the blob algebra. Varying the extra parameter, the blob algebra may be used to build the representations of the periodic Temperley–Lieb algebra ([40, 41, 16, 23, 21]). Thus all these algebras can be analysed using the

included-tower technology [12]. The next natural generalisation is the symplectic blob algebra (left-right symmetric *and* periodic). This sequence of algebras cannot be made to include in an appropriate way, and so presents a suitable challenge for our method.

In this paper we implement a *towers of recollement* programme, and variations, to determine the structure (bases and representation theory) of three interesting algebras. Many workers have considered wreath-like extensions for Brauer, Temperley–Lieb diagram [29, 41, 24, 16] and even partition algebras [6]. These extensions are of interest as testing grounds for techniques intended to be applied in the representation theory of more classical objects, such as the symmetric group. For example, one approach to systems of algebras with Jucys–Murphy-like elements [31, 46, 8] is to consider extensions of the algebras by new commuting generators which obey relations emulating identities obeyed by the Murphy elements. With careful preparation these extensions behave like wreaths (confer [47, 26, 12]). Here, considering the most general case of nonabelian wreath algebras, we also explore a new and intriguing set of interconnections, taking us to the symplectic blob algebra. This leads in particular to applications in boundary integrable statistical mechanics [14].

Planar diagram algebras (such as ordinary Temperley–Lieb) have been much studied (with useful consequences in both representation theory and physics), as have ‘fully non-planar’ algebras such as the partition algebra. These represent simplifying extremes in a range of generally harder problems. As mentioned above, certain annular algebras can be brought into the planar framework, using the blob algebra [41]. The algebras we focus on here are (in a suitable sense — see later) mildly non-planar diagram algebras. These are harder to treat, but not intractable, as we shall demonstrate.

The motivating aims of the paper are:

1. To provide an organisational framework for unifying the representation theory of various forms of periodic/annular/type-B/boundary TL algebras studied in the literature [40, 41, 54, 14]. (The ordinary Temperley–Lieb algebra is a nexus for many branches of mathematics, with isomorphic algebras constructed in areas such as: factors [29], representation theory, combinatorics, statistical mechanics [53, 3]. Variants appear in these contexts, but are no longer all isomorphic, and connections between them are not yet fully understood.)
2. To provide the representation theoretic formalism for analysing these algebras.

The layout of the paper is as follows. In section 2 we introduce the general theory necessary to pass specific basis elements, for special types of module, between layers of a globalisation tower (irrespective of inclusion). We also discuss how certain other features of modules which we shall use later behave under globalisation.

In section 3 we collect the definitions of one of the families of diagram algebras which we shall need. All of these are based on Weyl’s diagrams for the Brauer algebra [55]. To help prepare the ground for later more elaborate constructions we also point out some paradigms for diagram algebra construction. For example: combinatorial sets with diagrammatic realisations (which form bases for algebras via diagram concatenation), containing topologically characterised subsets respected by concatenation; with the resultant subalgebras amenable to deformations not tolerated by the original combinatorial algebra.

In section 4 we focus on deformations of Temperley–Lieb algebras — again looking

at subalgebras and deformations. We use these to establish homomorphisms between various families of algebras.

In section 5 we use the alternate realisations established above to construct new functors in the tower of blob algebras, and hence to relate categories of modules for blob algebras with different values of the defining parameters (and hence to analyse their representation theory).

In sections 6 and 7 we define affine symmetric Temperley–Lieb algebras and symplectic blob algebras, and relate their categories of modules.

In section 8 we investigate the representation theory of affine symmetric Temperley–Lieb algebras, using results from all the previous sections. The main results here are perhaps the simple indexing Theorem 8.1.3, and the generic structure results of section 8.5. Beyond the semisimple cases, we show that the algebra is almost always quasihereditary, and give bases for the standard modules.

Several of the incarnations of the Temperley–Lieb algebra have an interesting ‘periodic’ generalisation, as noted above, but these are much harder to treat. The blob algebra is a device that largely solves this problem — casting the representation theory of (infinite) periodic Temperley–Lieb algebras into the setting of a (finite) generalisation of TL with properties much closer to the original. The blob algebra suggests various generalisations of its own, but these are once again rather harder to treat, and have (until now) lacked the motivations of the blob algebra (i.e. its simple but beautiful representation theory; its application to periodic Temperley–Lieb and hence affine Hecke algebras). Recently, though, both the blob algebra and its two-boundary Temperley–Lieb algebra generalisation have arisen in the treatment of boundary integrable systems in Statistical Mechanics [14, 48], suggesting that category embedding methods should work here.

1.1 Preliminary definitions

A Coxeter graph is any finite undirected graph without loops (that is, without edges that begin and end on the same vertex). For example:

$$A_n : \begin{array}{c} \bullet \text{---} \bullet \text{---} \bullet \text{---} \dots \text{---} \bullet \text{---} \bullet \\ 1 \quad 2 \quad 3 \quad \quad \quad n-1 \quad n \end{array} \qquad B_n : \begin{array}{c} \bullet \text{---} \bullet \text{---} \bullet \text{---} \dots \text{---} \bullet \text{---} \bullet \\ 0 \quad 1 \quad 2 \quad \quad \quad n-2 \quad n-1 \end{array}$$

The Coxeter Artin system of Coxeter graph G is a pair (B, S) consisting of a group B and a set of pairs g_v, g_v^{-1} of generators of B labelled by the vertices v of G , with relations

$$g_v g_{v'} \dots = g_{v'} g_v \dots$$

where the number of factors on each side is two more than the number of edges between v and v' .

The Coxeter system of G is a pair (W, S) where $W = W(G)$ is the quotient of B by the relation $g_v = g_v^{-1}$.

For K a ring, let q_v be an invertible element in K , for each $v \in G$, such that $q_v = q_{v'}$ if g_v conjugate to $g_{v'}$ in B . Let $Q_v = (g_v - q_v)(g_v + q_v^{-1})$. The generic Hecke algebra of G is

$$H(G) = KB / \langle Q_v \mid v \in G \rangle$$

Examples: If $G = A_n$ then all generators are conjugate and we have the (one-parameter) Hecke algebras of type- A . If $G = B_n$ there is one generator not conjugate

to the rest and we have the (two-parameter) Hecke algebras of type- B . If $G = \tilde{C}_n$ there are two generators not conjugate to the rest, or to each other, and we have the (three-parameter) Hecke algebras of type- \tilde{C} .

Each of these algebras has an algebra homomorphism onto K defined by

$$\rho_+(g_v) = q_v$$

Note that for $q_v = 1$ the relation $Q_v = 0$ is $g_v^2 = 1$ and hence a group relation, so that $H(G)$ is the group algebra of $W(G)$ in this case. It will be convenient to write σ_v for g_v in the group case. We have [27, Ch.7] that if $w = \sigma_{i_1} \dots \sigma_{i_l}$ is a reduced expression in $W(G)$ then $\{T_w = g_{i_1} \dots g_{i_l} \mid w \in W(G)\}$ is a basis for $H(G)$ in general. Define the *symmetrizer*

$$E_G = \sum_{w \in W(G)} \rho_+(w) T_w$$

in $H(G)$. For example if the vertices of A_2 are labelled from $\{1, 2\}$ we have

$$E_{A_2} = 1 + q(g_1 + g_2) + q^2(g_1g_2 + g_2g_1) + q^3g_1g_2g_1.$$

Defining $u_v = (g_v + q_v^{-1})$, so that $g_v u_v = q_v u_v$, we have

$$E_{A_2} = q^3(u_1 u_2 u_1 - u_1).$$

If the vertices of B_2 are labelled from $\{0, 1\}$ we have

$$\begin{aligned} E_{B_2} &= 1 + q_1g_1 + q_0g_0 + q_0q_1(g_0g_1 + g_1g_0) + q_0q_1(q_0g_0g_1g_0 + q_1g_1g_0g_1) + (q_0q_1)^2g_0g_1g_0g_1 \\ &= u_0u_1u_0u_1 - \frac{q_0^2 + q_1^2}{q_0q_1}u_0u_1. \end{aligned} \quad (1)$$

Note that the relations of $H(G)$ are invariant under the parameter transformation

$$s_v : q_v \mapsto -q_v^{-1} \quad \text{and} \quad s_w : q_w \mapsto q_w \quad \text{for } g_v, g_w \text{ not in the same class}$$

(that is, there is one such transformation for each parameter). For each parameter transformation s_w there are, in addition to ρ_+ , further homomorphisms of $H(G)$ onto K :

$$\rho_w(g_v) = s_w(q_v).$$

Any subset of S generates a parabolic subalgebra of B or of $H(G)$. If $v, v' \in G$ have at least one edge between them define $E_{vv'}$ as the symmetrizer on their parabolic subalgebra of $H(G)$; else $E_{vv'} = 0$. Then define

$$T(G) = H(G) / \langle E_{v,v'} \mid v, v' \in G \rangle.$$

Example: $T(A_n)$ is the ordinary Temperley–Lieb algebra [53].

Not much is known about $H(G)$ or $T(G)$ for general G (although see [35, Ch.9]), but the cases in which G is positive definite or positive semidefinite are relatively tractable (although still interesting) [41, 20, 16, 15, 25].

For K a ring, x an invertible element in K , $q = x^2$, and $\gamma, \delta_e \in K$, define TLb_n^K to be the K -algebra with generators $\{1, e, U_1, \dots, U_{n-1}\}$ and relations

$$U_i U_i = (q + q^{-1})U_i \quad (2)$$

$$U_i U_{i\pm 1} U_i = U_i \quad (3)$$

$$U_i U_j = U_j U_i \quad (|i - j| \neq 1) \quad (4)$$

$$U_1 e U_1 = \gamma U_1 \quad (5)$$

$$e e = \delta_e e \quad (6)$$

$$U_i e = e U_i \quad (i \neq 1). \quad (7)$$

Note that e can be rescaled to change γ and δ_e by the same factor. Thus, if we require that δ_e be invertible, then we might as well replace it by 1. This brings us to the original two-parameter presentation of the algebra, sometimes known as the blob algebra by presentation, or the two-parameter Temperley–Lieb algebra of type B. The subalgebra generated by $\{1, U_1, \dots, U_{n-1}\}$ is $T(A_n)$, the Temperley–Lieb algebra of type A, sometimes denoted TL_n^K .

For k a field that is a K -algebra define $TLb_n = k \otimes_K TL_n^K$.

The type-A algebra is isomorphic to the well known ordinary Temperley–Lieb diagram algebra [35, 18]; and the algebra TLb_n is isomorphic to the blob diagram algebra b_n [41, 18, 23, 16] (see section 3.4). Because of these isomorphisms it is common to use generators and diagrams interchangeably.

There is also a *periodic* Temperley–Lieb diagram algebra (TLDA). That is, a TLDA defined using certain periodic TL diagrams. Continuing the above ‘duality’, the *periodic TLA*, on the other hand, is defined by abstract generators and relations. See [50, 33, 35, 40, 41, 16, 14] and references therein for details of both. The relationship between the two versions is not so straightforward as in the ordinary TLA case. See also [30, 20].

To summarize the naming conventions: Temperley–Lieb algebras are defined by generators and relations. Blob, contour, partition algebras (and others with diagram suggestive names) are defined via bases of diagrams and diagrammatic composition rules.

Proposition 1.1.1 *The map $u_i \mapsto U_i$ ($i > 0$), $u_0 \mapsto e$, extends to an algebra homomorphism ϕ from $T(B_n)$ to TLb_n^K in the case $q = q_1$, $\delta_e = q_0 + q_0^{-1}$ and $\gamma = \frac{q_0^2 + q_1^2}{q_0 q_1}$.*

Proof: The relation checking is largely routine. Note from (1) that $\phi(u_1 u_0 u_1 - \frac{q_0^2 + q_1^2}{q_0 q_1} u_1)$ vanishing is sufficient to ensure $\phi(E_{B_2}) = \phi(u_0(u_1 u_0 u_1 - \frac{q_0^2 + q_1^2}{q_0 q_1} u_1)) = 0$. \square

Several authors have used this so-called ‘blob’ homomorphism to investigate Hecke algebra representation theory in the type- B and type- \tilde{A} cases [21, 11, 43]. One final way to view the present paper is as a similar ‘blob’ approach to type- \tilde{C} . (The three parameter affine- C Hecke algebra itself is of interest for a variety of reasons — see for example [34, 52] and references therein.)

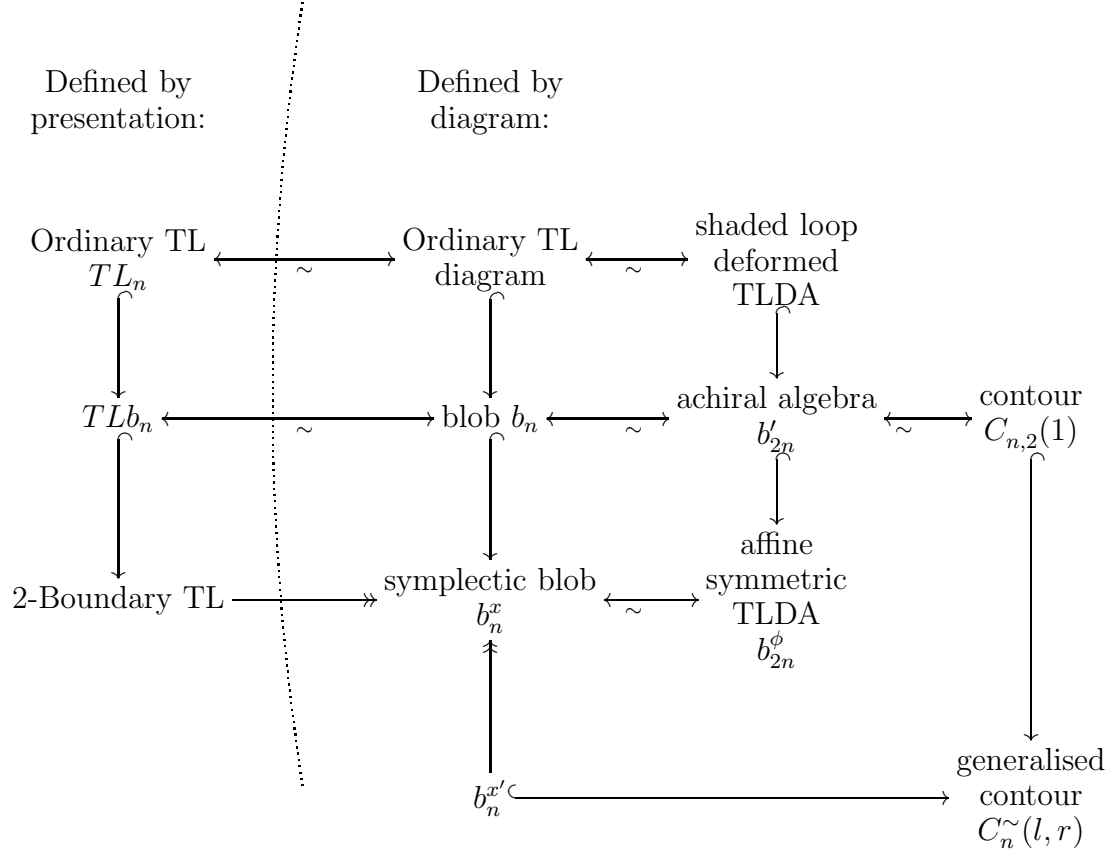

Figure 1: Algebra relationships

1.2 Summary of notations

For the reader's reference we summarize here the notations for algebras used in this paper (and indicate the section in which each is defined):

b_n blob algebra, section 3.4

b'_n achiral algebra section 4

b_n^x symplectic blob algebra, section 6

$b_n^{x'}$ big symplectic blob algebra, section 6

b_{2m}^ϕ affine symmetric Temperley–Lieb diagram algebra, section 7

\mathfrak{B}_n Brauer algebra, section 3

$C_{n,m}(l)$ contour algebra, section 3.3

$C_n^\sim(l)$ generalised contour algebra, section 3.3

$H(G)$ generic Hecke algebra of graph G , section 1.1

TL_n Temperley–Lieb algebra of type-A, section 1.1

TLb_n Temperley–Lieb algebra of type-B, section 1.1

$T(G)$ a quotient of $H(G)$, section 1.1

The relationship between these algebras is indicated by the schematic in figure 1. A glossary of other notations used for sets may also be useful:

B_n set of blob diagrams, section 3.4
 B_n^x set of left-right blob diagrams, section 6.1
 B_n^ϕ set of left-right symmetric reduced periodic pseudodiagrams, section 7.2
 $D(V)$ set of beaded diagrams (given vertex set $V = V_n$ and bead set S), section 3.1
 $D^o(V)$ beaded pseudodiagrams, section 3.1
 D_n^z planar diagrams, section 3.3
 $D_n^{z,l}$ planar l -exposed diagrams, section 3.3
 $D_n = D_{n,m}$ planar diagrams with \mathbb{Z}_m -beads, section 3.3
 D_n^p cylinder embeddable diagrams, section 3.5
 D_n^{pc} isotopy classes of concrete cylinder diagrams, section 3.5
 D^{pc} classes of concrete cylinder diagrams including non-contratible loops, section 3.5
 D_n^ϕ classes of left-right symmetric concrete cylinder diagrams, section 7.1
 J_n unbeaded diagrams, section 3.1
 J_n^z planar unbeaded diagrams, section 3.4
 $J_{(n)}$ periodic unbeaded diagrams, section 3.2
 J_n^B symmetric planar unbeaded diagrams, section 4.2
 J_n^{Be} symmetric planar unbeaded *ede* diagrams, section 5

2 Category theory preliminaries

The starting point at the category theory level is as follows. Given an algebra A and an idempotent $e \in A$ then eAe is also an algebra, and Ae is a left A module and a right eAe module. Thus we may define functors between the category $A\text{-mod}$, of left A -modules, and $eAe\text{-mod}$:

$$\begin{aligned}
G : eAe\text{-mod} &\longrightarrow A\text{-mod} & (8) \\
M &\mapsto Ae \otimes_{eAe} M
\end{aligned}$$

$$\begin{aligned}
F : A\text{-mod} &\longrightarrow eAe\text{-mod} & (9) \\
N &\mapsto eN
\end{aligned}$$

with various powerful properties (summarized in [22, 39]). In particular if A is an algebra over a field then F is exact and G is right exact. Further, the image of a simple module under G has simple head.

Proposition 2.0.1 [22] *Let $\{S_\lambda \mid \lambda \in \Lambda\}$ be a complete set of inequivalent simple (left) modules of eAe over some field. Then $\{\text{head}(G(S_\lambda)) \mid \lambda \in \Lambda\}$ is a set of inequivalent simples of A , and any simple A -module S in an equivalence class not represented in this set obeys $eS = 0$.*

2.1 Prestandard modules

The functor F is called localisation, and G is globalisation, with respect to e . (We may write F_e, G_e where convenient.) Suppose that we are given an idempotent e in an algebra A , and that S is a simple module of eAe . Then $G(S)$ is called the *prestandard* module of A associated to S by e .

Indeed, suppose that $e = e_1e_2 = e_2e_1$ (e_1, e_2 also idempotent). Then the sequence of idempotents $1, e_1, e$ defines a sequence of algebras A, e_1Ae_1, eAe . A prestandard module $M = G_{e_2}(S)$ of e_1Ae_1 will globalise to a prestandard module of A . On the other hand if $M \neq \text{head}(M)$ then these two will not necessarily globalise to the same module in A (although both are of prestandard type by construction). This makes the prestandard notion less canonical, although more general, than the *standard* modules of quasihereditary algebras, for example.

Proposition 2.1.1 *If M is a prestandard A -module then*

- (i) *it has simple head L_M (say), and if M_0 is the maximal proper submodule then M_0 does not contain L_M as a simple composition factor;*
- (ii) *if A has an involutive antiautomorphism defined on it fixing e then M has at most one contravariant form defined on it, up to scalars, and the rank of any such form is the dimension of L_M .*

Proof: (i): Only the last claim remains to be proven. Suppose that $M = G(S)$ for simple eAe -module S , then $F(M) = eM \cong S$. In particular e acts as zero on all but one simple factor in M . Now suppose there exists a proper submodule M' of M . If $eM' \neq 0$ then $eM' = S = eG(S)$, so $AeM' = AeG(S) = G(S)$, which would imply $M' \supseteq G(S) \supset M'$ — a contradiction. Thus F kills every proper submodule of M , so $eL_M \neq 0$.

(ii): There is a one-to-one correspondence between such forms and homomorphisms from M to its contravariant dual M^\times , but by (i) there is at most one such homomorphism (up to scalars), whose image is L_M . To see this note that by the proof of (i) $eL_N = 0$ for every simple factor L_N of M not in the head. Let L_M^\times denote the contravariant dual of L_M , a simple module. Since $eL_M \neq 0$ we have $eL_M^\times \neq 0$ so neither L_M nor L_M^\times appears below the head in M . Thus L_M does not appear above the socle in M^\times and a homomorphism $M \rightarrow M^\times$ is only possible if it maps the head L_M of M to the socle L_M^\times of M^\times , with $L_M \cong L_M^\times$. \square

Propositions 2.0.1 and 2.1.1 and the exactness properties make prestandard modules potentially useful modules to study, in representation theory. In this paper we will encounter various modules (for algebras) with useful natural bases. It will be convenient, where possible, to be able to identify these as prestandard.

2.2 Globalisation and balanced maps

The exactness properties of G and F are standard results (see [39, 22]). However it is worth unpacking a little before we go on, since some of the mechanics will be used later. The first thing to recall is the notion of balanced map [9, 13]. For M a right module and N a left module of a ring R with 1, a balanced map f of $M \times N$ into an additive abelian group P is a map such that $f(m + m', n) = f(m, n) + f(m', n)$, $f(m, n + n') = f(m, n) + f(m, n')$, $f(m, rn) = f(mr, n)$.

The map that takes (m, n) to $m \otimes n \in M \otimes_R N$ is a balanced map. If $f : M \times N \rightarrow P$ is balanced then there is a homomorphism $f^* : M \otimes_R N \rightarrow P$ such that $f^*(m \otimes n) = f(m, n)$ (in fact f^* is uniquely determined by f) [13].

Now consider

$$F(G(N)) = eAe \otimes_{eAe} N \xrightarrow{\mu} N$$

where μ is derived from the (NB, balanced) map

$$(a, n) \mapsto an.$$

We may define a homomorphism $\nu : N \rightarrow eAe \otimes_{eAe} N$ by

$$\nu(n) = e \otimes n \tag{10}$$

Obviously $\mu\nu$ is the identity map on N ; and

$$\nu(\mu(a \otimes n)) = \nu(an) = e \otimes an = a \otimes n$$

since $a \in eAe$, so μ is an isomorphism.

Similarly we have that

$$G(eAe) = Ae \otimes_{eAe} eAe \cong Ae. \tag{11}$$

More generally, suppose that S is a left sub- eAe -module of eAe (i.e. a left ideal), then there is a multiplication map

$$\begin{aligned} \mu : Ae \otimes_{eAe} S &\rightarrow AeS \\ ae \otimes s &\mapsto aes \end{aligned}$$

(in the rest of this section, μ applied to a tensor product of this form will always be the appropriate multiplication map) however, this surjection need not be an injection in general. (There is a grotesque example in [13].) The issue is the construction of the ‘inverse’ as in (10). The ‘identity element’ $e \in eAe$ will not generally lie in S . On the other hand, suppose that there are $f, g \in eAe$ such that $S = eAef$ and $fgf = f$. (Such an f is said to satisfy the *return condition*. We call a left eAe -ideal S of form $eAef$ with f satisfying the return condition a *return ideal*.) Then there is a map $\nu : AeS \rightarrow Ae \otimes_{eAe} S$ given by

$$\nu(x) = x \otimes gf$$

so that $\mu(\nu(x)) = xgf = x$ and $\nu(\mu(a \otimes s)) = \nu(as) = as \otimes gf = a \otimes s$. Therefore

Proposition 2.2.1 *If $S = eAef$ is a left ideal of eAe generated by $f \in eAe$ such that $fgf = f$ for some $g \in eAe$, then the multiplication map μ is an isomorphism*

$$G(S) \cong AeS = AS = Af$$

(NB, μ and its inverse are given explicitly). In particular the set inclusion of S in AS passes to an injection ν of S into $G(S)$. This is not an algebra-module map, but if D is a linearly independent set in S then it is linearly independent in AS and $\nu(D)$ is in $G(S)$.

Note that fg is idempotent, so

$$S = eAef \twoheadrightarrow eAefg$$

is a surjective map to a projective eAe -module.

2.3 Module bases under globalisation

The functors F, G are tools for analysing categories of modules, rather than specific bases or representations. However, following the discussion above, there are realistic cases in which one can use a basis for S to construct a basis for $G(S)$. (This is particularly so for diagram algebras, which come with a diagram basis for elements f of which the return condition $fgf = f$ is always true for some algebra element g . Indeed g can usually be chosen a basis element, or else a scalar multiple thereof.)

Proposition 2.3.1 *Let S be a submodule of the (left) regular module of eAe , and suppose that this submodule has basis D . Then the concrete set of elements $e \otimes D$ is independent in and will also generate $G(S)$. Further,*

$$G(S) \xrightarrow{\mu} AS \hookrightarrow G(eAe) \stackrel{(11)}{\cong} Ae \hookrightarrow A$$

as left A -modules.

Proof: For $d \in D \subset S$ then $e \otimes d \in Ae \otimes_{eAe} S = G(S)$. The image $\mu(e \otimes d) = d$, so $\mu(e \otimes D) = D$. On the other hand, the direct set map $D \hookrightarrow AD$ is an inclusion, so D is linearly independent in AS . The multiplication map $\mu : G(S) \rightarrow AS$ is surjective, not necessarily bijective, but it is still a module homomorphism. Thus if $e \otimes D$ were to be linearly dependent in $G(S)$, the image D would be linearly dependent in AS — a contradiction. So the set $e \otimes D$ is linearly independent.

On the other hand D spans S , so $Ae \otimes D$ spans $G(S)$. Thus $e \otimes D$ extends to a basis of $G(S)$ by the exchange theorem. If the multiplication map μ is bijective then $G(S)$ has a natural isomorphic image in A , with a basis which contains D as a subset.

Finally $eD = D \subset eAe$, so $AeD \subset Ae$. \square

Proposition 2.3.2 *Suppose that $S_1 \xrightarrow{\psi} S_2$ is an inclusion of return ideals. Then $G(S_1) \xrightarrow{G(\psi)} G(S_2)$, i.e. G behaves as if left exact.*

Proof: Unpacking the assumptions then $eAef_1 \hookrightarrow eAef_2$, so $f_1 \in eAef_2$. Let us say (WLOG) $f_1 = ff_2$. We have

$$\begin{array}{ccc} eAef_2 & \xrightarrow{\psi} & eAef_2 \\ \downarrow G & & \downarrow G \\ Ae \otimes_{eAe} ff_2 & \xrightarrow{G(\psi)} & Ae \otimes_{eAe} f_2 \\ \downarrow \mu_1 & & \downarrow \mu_2 \\ Af_2 & \hookrightarrow & Af_2 \end{array}$$

Since both μ -maps are isomorphisms, there are two ways of constructing a homomorphism in the middle: via the functor G ; or via the bottom row inclusion $\nu_2(\mu_1(a \otimes f f_2)) = \nu_2(a f f_2) = a f f_2 \otimes g_2 f_2 = a \otimes f f_2 = a f \otimes f_2$. Again since the multiplication maps are isomorphisms, the latter construction is an injection, i.e. $G(S_1) \hookrightarrow G(S_2)$. On the other hand $G(\psi)(a \otimes f f_2) = a \otimes \psi(f f_2) = a \otimes f f_2 \in G(S_2)$, so $G(\psi)$ and $\nu_2 \circ \mu_1$ are the same map. (NB, for $M \hookrightarrow N$ the element $a \otimes m \in G(M)$ is not the same thing as $a \otimes m \in G(N)$ in general — a set of such objects can be independent in $G(M)$ and not in $G(N)$, but here we can also build such objects on the $G(S_2)$ side by the kernel-free $\nu_2 \circ \mu_1$ route.) \square

Indeed, suppose that

$$S_1 \hookrightarrow S_2 \hookrightarrow \dots \hookrightarrow eAe \tag{12}$$

is a nested sequence of return ideals, and D_i a basis for each such that $D_i \subset D_{i+1}$. Consider the sections defined by this sequence:

$$0 \rightarrow S_i \xrightarrow{\psi} S_{i+1} \rightarrow S_{i+1}/S_i \rightarrow 0$$

then $G(S_i) \hookrightarrow G(S_{i+1})$ and $G(S_{i+1}/S_i) = G(S_{i+1})/G(S_i)$. Thus in particular if S_{i+1}/S_i is simple then $G(S_{i+1})/G(S_i)$ is prestandard.

It may be that (12) is valid over a ground ring that specialises to a field in a number of different ways. Then the sections of the sequence make sense (both before and after globalisation) over the ring, and prestandard modules have the flavour of Specht modules [28].

Diagram algebras come with bases with special properties. We will use this concrete construction to decompose the regular module explicitly throughout entire towers of algebras.

3 Diagram algebras: initial examples

In order to define diagram algebra quotients of Hecke algebras later, we start by defining related algebras which have both diagram and ‘linear’ realisations.

3.1 Brauer algebra wreaths

Fix $n, m \in \mathbb{N}$ with $n + m$ even, and let $V_m^n = \{1, 2, \dots, n, 1', 2', \dots, m'\}$, called the set of vertices. Write $V = V_n$ for V_n^n . Write J_m^n for the set of pair partitions of V_m^n (so $J_n := J_n^n$ is the usual basis of the Brauer algebra \mathfrak{B}_n [7, 55]). For S a set, an S -decorated pair partition is an element of J_m^n together with a map from the set of pairs to the set of words in S . Fixing S , write $D(V_m^n) = D_S(V_m^n)$ for the set of such objects. Thus $D_\emptyset(V_n^n) \cong J_n$.

Let

$$p = \{\{i, j\}, \{k, l\}, \dots\}$$

be a pair partition of V_m^n . Then we may write $d \in D(V_m^n)$ as

$$d = \{\{i, j\}_{w_1}, \{k, l\}_{w_2}, \dots\}$$

where w_l is the word in S associated to the l -th pair. (We adopt the convention of omitting the subscript when the word is the empty word.) We call this the *serial* realisation of $d \in D(V_m^n)$. We next describe two further useful realisations.

It will be helpful to think of the following mild extension to Weyl's [55] diagram realisation of the pair-partition basis in the Brauer algebra. Consider:

- (i) the vertices as arranged on a rectangular frame, 1 to n across the top edge, $1'$ to m' across the bottom;
- (ii) the pairings as pieces of string (called *lines*) appropriately connecting vertices;
- (iii) the accompanying elements of S as threaded beads, threaded in the order indicated by the word (reading from vertex i to j' , or from i to j if $i < j$, or from i' to j' if $i < j$).

(Note that any tangling of strings, perhaps arising from some perceived embedding in an underlying space, is irrelevant here — it is only the pairings they define that matter.)

A third realization is achieved by arbitrarily embedding [2] each string $\{i, j\}$ as a line from i to j in the plane region bounded by the frame rectangle. For example

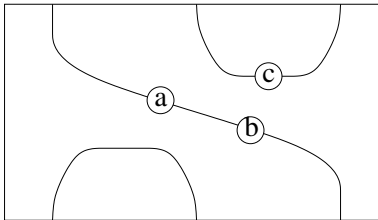
$$\{\{1, 3'\}_{ab}, \{2, 3\}_c, \{1', 2'\}\} =$$

NB, it is not possible in general to do this without distinct lines crossing (see later, and cf. [29]).

In summary: we will call objects in the first realisation decorated pair partitions; objects in the string/bead realisation diagrams; and objects in the third realisation concrete diagrams.

Pseudodiagrams

Consider the idea of closed loops of string in the string/bead picture — that is, strings that do not end on any of the vertices. Corresponding to this, it will be convenient to extend the notion of decorated pair partitions to include (possibly multiple) copies of the empty set in the partition. (Hence we make mild abuse of this terminology.) Following [42] we call such diagrams augmented by zero or more loops (*Brauer*) *pseudodiagrams*, and the extended partitions *pseudopartitions*. For example (with $\{\}^l$ denoting l copies)

$$d = \{\{1, 3'\}_{ab}, \{2, 3\}_c, \{1', 2'\}, \{\}_{def}, \{\}^2\} = \{\{1, 3'\}_{ab}, \{2, 3\}_c, \{1', 2'\}, \{\}_{edf}, \{\}^2\}$$

As before, any perceived embedding of these loops in an underlying space is irrelevant — thus in particular a loop does not have an orientation or starting point for the reading off of bead sequences. Thus $\{\}_{def} = \{\}_{edf}$.

Definition 3.1.1 We write $D^o(V_m^n)$ for the set of (n, m) -pseudodiagrams. If $d \in D^o(V_m^n)$ is a pseudodiagram let $c_d \in D(V_m^n)$ denote the underlying diagram, that is, the diagram obtained by omitting any loops; and $c_d^o \in D^o(V_0^0)$ the complement, obtained by keeping only loops.

For w a word in S let w^o denote the opposite word (the word with the same letters, but written in the reverse order). In the serial (pair-partition) realisation, if we write a vertex pair in a definite (not necessarily canonical) order: (i_1, i_2) , then the string/bead datum for this string obeys

$$(i_1, i_2)_w = (i_2, i_1)_{w^o} \quad (13)$$

On the other hand if a pseudodiagram has a closed loop then this may again have beads on it, but reading the sequence of beads depends on an arbitrary choice of starting point and direction round the loop. We say two words are *loop equivalent* if one can be changed to the other or its opposite by any cyclic permutation. (Note that loop equivalence is an equivalence relation on the set of words.) Thus the bead sequence on a loop is only defined up to loop equivalence.

We *concatenate* pseudodiagrams $d_1 \in D^o(V_m^n)$, $d_2 \in D^o(V_l^m)$ to form a pseudodiagram $d_1 d_2 \in D^o(V_l^n)$ as follows. Pass to the string/bead realisation and there juxtapose the vertices $1', 2', \dots, m'$ in d_1 with the corresponding unprimed vertices in d_2 . Some of the chains of string resulting from this concatenation will connect pairs among the unprimed vertices in d_1 and the primed vertices in d_2 (defining a new diagram $c_{d_1 d_2}$ on these vertices), and some will form closed loops. Because of the string/bead realisation we call this the *abacus product* on pseudodiagrams.

For example

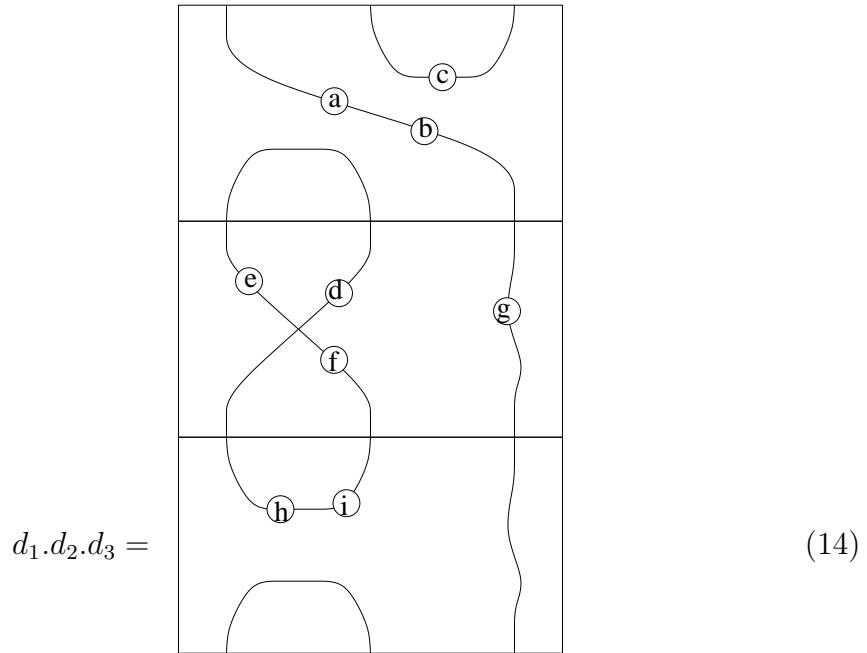

is

$$\begin{aligned} & \{\{1, 3'\}_{ab}, \{2, 3\}_c, \{1', 2'\}\} \cdot \{\{1, 2'\}_{ef}, \{3, 3'\}_g, \{2, 1'\}_d\} \cdot \{\{1, 2\}_{hi}, \{3, 3'\}, \{1', 2'\}\} \\ & = \{\{1, 3'\}_{abg}, \{2, 3\}_c, \{1', 2'\}, \{efihd\}\}. \end{aligned}$$

To confirm that this product is well defined note that in the ordered pair form of the serial realisation (13) composition is given by a sequence of m replacements of form:

$$\underbrace{\{\dots (i_1, i'_2)_w \dots\}}_{d_1} \underbrace{\{\dots (i_2, i_3)_{w'} \dots\}}_{d_2} \rightsquigarrow \{\dots (i_1, i_3)_{ww'} \dots\}$$

and

$$(i_1, i_1)_w \rightsquigarrow ()_w = \{ \}_w$$

the order of application of which, when not forced, produces no ambiguity.

Proposition 3.1.2 *The abacus product is associative. The closed case with $n = m = l$ is unital. Hence D° is a category with object set \mathbb{N} and (n, m) morphism set $D^\circ(V_m^n)$.*

Proof: Associativity follows from the construction. For an example, consider $(d_1 d_2) d_3$ and $d_1(d_2 d_3)$ in equation (14) — one draws the same picture in each case.

The identity element is the pair partition \mathbb{I} :

$$\mathbb{I} = \{ \{1, 1'\}, \{2, 2'\}, \dots, \{n, n'\} \} \quad (15)$$

(all words empty). \square

Fix K a ring and $\delta_w \in K$ for each w a loop class representative word in S .

Definition 3.1.3 *For each $d \in D^\circ(V_m^n)$ define a scalar $k_d \in K$ by*

$$k_d = \prod_l \delta_{w_l}$$

with a factor δ_{w_l} for each closed loop l in d with bead sequence w_l .

An example follows shortly.

Define a map

$$\begin{aligned} D(V_m^n) \times D(V_l^m) &\rightarrow K \times D(V_l^n) \rightarrow KD(V_l^n) \\ (d_1, d_2) &\mapsto (k_{d_1 d_2}, c_{d_1 d_2}) \mapsto k_{d_1 d_2} c_{d_1 d_2} \end{aligned} \quad (16)$$

(recall that the strings of diagram $c_{d_1 d_2}$ are the open chains from the abacus product, each carrying the accumulated beads of this chain in the natural order).

Since the underlying abacus product is associative, this (16) extends to an associative unital product on $KD(V_n^n)$. For example, in equation (14) $(d_1 d_2) d_3 = \delta_w \{ \{1, 3'\}_{abg}, \{2, 3\}_c, \{1', 2'\} \}$ where w represents the class containing $efihd$.

Remark: This product is amenable to massive generalisation, which we will largely ignore, but see for example [36, 29, 1]. A milder generalisation is the *cyclotomic* variant, in which

$$(i_1, i_2)_{s_1 s_2 \dots} = (i_2, i_1)_{\dots s_2^t s_1^t}, \quad (17)$$

where t is an involutive map on $\langle S \rangle$ that does not necessarily fix elements of S .

3.2 Periodic pair-partitions

Consider the ‘infinite’ rectangular frame in which the primed and unprimed vertices are labelled by corresponding copies of the set of integers. The set of arbitrary pair-partitions of this vertex set (call it V_∞) is rather unmanageable, but there are a number of more manageable subsets which are closed under composition (ignoring loops). A pair-partition is said to be n -periodic if for every pair $\{i, j\}$ there are pairs $\{i \pm n, j \pm n\}$ (with $m' \pm n := (m \pm n)'$). It follows that there are only n

distinct orbits of pairs. An n -periodic pair-partition can be specified by listing a fundamental subset of n pairs.

The first element in each such pair (at least) can be chosen to lie in the fundamental set V_n^n . Then if $(i_1, i_2) = (i_1, \bar{i}_2 + mn)$ where \bar{i}_2 also lies in V_n^n we might write $(i_1, \bar{i}_2)_m$ for (i_1, i_2) . Using this notation we can demonstrate a map from decorated pair partitions on V_n^n with bead set $S = \{L_+, L_-\}$, and $L_+^t = L_-$ the involution as in equation (17), to n -periodic pair partitions. We take a string with m beads $(i_1, i_2)_{L_\pm^m}$ to $(i_1, i_2)_{\pm m}$ ($m \geq 0$). In other words each bead L_+ corresponds to winding once clockwise round the period, and L_- is anticlockwise (thus we take the quotient with $L_+L_- = L_-L_+ = 1$).

We write $J_{(n)}$ for the set of n -periodic pair-partitions. There are infinitely many of these. For example with $n = 1$ we have $\{\{1, m'\} \mid m \in \mathbb{Z}\}$ (writing only a fundamental subset for each partition).

For later convenience it will be useful sometimes to index vertices by odd integers rather than all integers. When we do this we will write the pair partition $\{\dots\}_o$. For $n = 2$ examples include

$$\{\{1, 7\}, \{1', 7'\}\}_o.$$

Note that this pair-partition can be realised by vertex-connecting lines embedded in the infinite rectangular interval, as in the finite case. But note that in this example these lines necessarily cross (the orbit of $\{1, 7\}$ includes $\{-3, 3\}$ and $\{5, 11\}$ for example). For $n = 4$ examples include

$$\{\{1, -1\}, \{3, 5\}, \{1', -1'\}, \{3', 5'\}\}_o \quad \{\{1, 3\}, \{-1, -3\}, \{1', 3'\}, \{-1', -3'\}\}_o.$$

Note that these particular examples can be realised by non-crossing lines.

Under composition, ignoring loops for a moment, it is a simple exercise to show that n -periodicity is preserved. Two types of loops can appear: an ‘orbit’ of loops individual members of which are periodic images of one another; and an individual ‘non-contractible’ loop which is mapped into *itself* by periodicity. Finitely many instances of each type may be created in composition. We will see in section 3.5 a natural way to keep track of these (and any possible decorations). Thus, given two different types of loop, we may introduce a set of periodic pseudodiagrams, which is then closed under composition. It will also be convenient to introduce the set $J'_{(n)}$ of periodic diagrams augmented just by the non-contractible type of loops. A suitable collection of relations removing the orbits of loops then makes $J'_{(n)}$ a basis for an algebra generalising the Brauer algebra (cf. [49]).

There is an injective homomorphism from J_n into $J_{(n)}$ which simply uses $p \in J_n$ as the fundamental subset. This can be extended to an algebra map.

We write $J_{(n)}^S$ for the beaded version of $J_{(n)}$.

3.3 Planar embeddings and contour algebras

Definition 3.3.1 (1) A diagram in $D(V_m^n)$ is called planar if it is possible to embed the strings in the plane interior to the rectangle (touching the boundary only at the vertices) in such a way that they do not (self-intersect or) touch one another.

(2) Any specific such embedding is called a concrete planar diagram.

(3) If one concrete planar diagram may be continuously deformed into another, with

all the intermediate stages concrete planar diagrams, then the diagrams are said to be isotopic [45].

Proposition 3.3.2 *Two concrete planar diagrams are isotopic if and only if they are realisations of the same underlying diagram. \square*

Remark 3.3.3 If we consider planar pseudodiagrams in the same way, then a given Brauer pseudodiagram may have more than one isotopy class of planar embeddings. Note however that both c_d and k_d can be considered as applying to planar pseudodiagrams via their underlying Brauer pseudodiagrams.

Write $D_n^z \subset D(V_n^n)$ for the set of planar diagrams. It will be evident that the restriction of diagram composition (16) to D_n^z closes on KD_n^z .

Definition 3.3.4 *A string in a planar diagram is called exposed (or 0-covered) if it may be deformed isotopically to touch the western frame edge, and l -covered if it may be deformed to touch an $(l - 1)$ -covered line and no lower.*

Let $D_n^{z,l} \subset D_n^z$ denote the subset of planar diagrams in which only the l' -covered lines with $l' \leq l$ may be decorated (i.e. beaded, i.e. map to other than the empty word).

Proposition 3.3.5 *The restriction of diagram composition (16) to $D_n^{z,l}$ closes on $KD_n^{z,l}$.*

Proof: Composition may expose new line segments, but it cannot cover any that were previously exposed (since the relevant part of the western frame is still in place). Thus any decorated (hence no more than l -covered) line remains no more covered (hence decorable) in composition. \square

We now note some specialisations with interesting finite dimensional quotients.

Fix bead set S of order one ($S = \{L\}$, say). It follows that words in S are all of form L^i , and that each is in a separate loop class. Write $\delta_i := \delta_{L^i}$. Fix $m \in \mathbb{N}$ and let $D_n = D_{n,m}$ denote the subset of D_n^z in which no string carries more than $m - 1$ beads. Consider the K -algebra with basis D_n^z and $\delta_{i+m} = \delta_i$. With this specialisation of the parameters we may impose the quotient relation that m beads together may be cancelled ($L^m = 1$). This produces an algebra $C_{n,m}$ with basis $D_{n,m}$ ($D_{n,m}$ is clearly spanning; to see that it is independent note that the relation cannot be used to change the *shape* of a diagram).

Definition 3.3.6 *Define $C_{n,m}(l)$ as the subalgebra of $C_{n,m}$ spanned by $D_n^{z,l}$ (and hence with basis $D_{n,m}^{z,l} := D_n^{z,l} \cap D_{n,m}$). These are called contour algebras (see [12]).*

More generally, the ‘algebra’ taking place on a single string is the free monoid on the generators S . Every quotient by some set of relations \sim to a finite monoid (or even K -algebra with basis a finite subset of the free monoid), together with a consistent specialisation of the parameters, induces a finite generalised contour algebra $C_n^\sim(l)$. (Here K -linear combinations of words on a string pass linearly to corresponding K -linear combinations of diagrams.)

As usual the identity in these contour algebras is the pair partition \mathbb{I} . Suppose that $L \in S$. We define $L_i \in D(V_n^n)$ as the diagram that is \mathbb{I} as a pair partition, but has the single letter word L on the i -th string, with all other words empty.

Define U_i as the diagram differing from \mathbb{I} in having the pairs $\{i, i+1\}, \{i', (i+1)'\}$.

Proposition 3.3.7 *The algebra $C_{n,m}(l)$ with $m > 1$, $l < n$, $S = \{L\}$, is generated by the set*

$$\{\mathbb{I}\} \cup \{L_i\}_{i=1}^{l+1} \cup \{U_i\}_{i=1}^{n-1}.$$

Proof: See Appendix. \square

Note that in case $m = 2$ we may replace the relation set $\sim = \{LL = 1\}$ (giving $L_i L_i = \mathbb{I}$) with $\sim = \{LL = L\}$ (giving $L_i L_i = L_i$) and obtain an isomorphic algebra. Indeed we may deform the monoid (algebra) via $LL = \kappa L$ similarly (giving $L_i L_i = \kappa L_i$). Only the case $\kappa = 0$ departs from the rest.

It will be evident that similar definitions to $C_n^\sim(l)$ may be constructed for *eastern* exposure, and for composites $C_n^\sim(l, r)$. Also of interest, as it turns out, are subalgebras of the case $S = \{L, R\}$ generated by

$$\{\mathbb{I}, L_1, R_n\} \cup \{U_i\}_{i=1}^{n-1}.$$

where \sim defines a certain noncommutative monoid. (Note that this choice of generators prescribes the way in which L and R can meet, which leads to some interesting topological effects — see later.)

3.4 Direct homomorphisms with known algebras

Definition 3.4.1 *A Temperley–Lieb (TL) diagram is an isotopy class of concrete planar diagrams, or any representative thereof. Ordinary TL diagrams are beadless.*

By Proposition 3.3.2 the subset $J_n^z \hookrightarrow D_n^z \hookrightarrow D(V_n^n)$ with no beads is in bijection with the set of ordinary Temperley–Lieb diagrams on two rows of n vertices.

Definition 3.4.2 [41] *The set B_n of blob diagrams is the set of decorated TL diagrams on two rows of n vertices in which western exposed lines, only, may be decorated, with at most a single bead (‘blob’) on each.*

For example, for any given n the diagram $e \in B_n$ has the shape of the identity diagram (n vertical lines), but with the leftmost line decorated with blob.

The blob algebra $b_n = b_n(\delta = q + q^{-1}, \delta_e, \gamma)$ (as in [41], but as parameterised in [39]), is generated by TL diagrams and e , with two blobs on a line appearing in composition replaced via:

$$ee = \delta_e e \tag{18}$$

and a loop decorated by a blob replaced by a factor of γ . Thus $b_n(\delta, \delta_e, \gamma)$ has basis B_n .

It is easy to show that

Proposition 3.4.3 *For all n :*

(i) *The subset J_n^z of D_n^z generates a finite dimensional algebra isomorphic to the ordinary Temperley–Lieb algebra $TL_n(\delta_0 = q + q^{-1})$ [53].*

(ii) *The set $D_{n,2}^{z,0}$ is essentially identical to the set of blob diagrams B_n , with $L_1 = e$. The algebra $C_{n,2}(0)$ is isomorphic to the blob algebra b_n [41] and to TLb_n (more generally, $C_{n,m}(0)$ is the coloured blob algebra mentioned in [44]).*

(iii) *The case $C_{n,m}(n) = C_{n,m}(\infty)$ is isomorphic to the cyclotomic Temperley–Lieb algebra [12]. \square*

Note (from section 2 of [12]) that the tower of recollement framework applies to all of the above algebras.

Following the largely physically motivated investigation of the ordinary Temperley–Lieb algebra in the 1980s, the blob algebra was introduced in order to allow use of the western edge of the frame (actually either one) as a cohomology seam, and hence to address the *periodic* Temperley–Lieb algebra (again, originally, with physical motivation). The very first level of exposure is sufficient for this purpose (see the literature, for example [41, 21]). Interest in the ‘homogeneous’ case (i.e. not filtered by exposure) has been slower to arise, but now see [51] and [29] (whose primary interest is in subfactors). The general intermediates have yet to find a physical application.

3.5 Diagram embeddings, subalgebras and deformations

This section describes ‘topological’ realisations of certain subsets of diagrams, generalising the planar embedding of definition 3.3.1, and the deformations of the algebra product possible in these cases.

Isotopy:

A brief remark is in order on the general notion of isotopy following from the benign paradigm in definition 3.3.1. A realisation of a (pseudo)diagram is called a picture if it is an arbitrary choice among a continuum of such realisations of the same diagram. (The existence of such realisations — faithful but non-canonical *drawings* of the diagram — is at the heart of the use of the word diagram to describe these objects.) Suppose we have a subset of a set of diagrams characterised by the existence of pictures satisfying certain properties (such as the concrete planar embedding in definition 3.3.1). Then given a picture of a diagram, another diagram realisation is said to be *isotopic* to it if they belong to a continuum of pictures all satisfying the characterising property.

We note as a paradigm for later reference that when restricted to D_n^z the product in (16) is amenable to deformation. This is firstly because the orientation of loops becomes an invariant of isotopy (a loop cannot be flipped without some intermediate crossing). Thus $\delta_w = \delta_{w'}$ is only necessary if w, w' related by a cyclic permutation.



Secondly, the nonisotopic placement of loops noted in remark 3.3.3 gives scope for further deformation (see section 4).

Definition 3.5.1 (1) Consider the manifold constructed from the plane interior to the boundary rectangle of a diagram by identifying the eastern and western edges (a cylinder). A diagram in $D(V_m^n)$ is called *periodic* if it is possible to embed the strings in this manifold (touching the northern and southern boundaries only at the vertices) in such a way that they do not touch one another.

(2) Any specific such embedding is called a *concrete periodic diagram*.

(3) If one concrete periodic diagram may be continuously deformed into another, with

all the intermediate stages concrete periodic diagrams, then the diagrams are said to be isotopic [45].

For example, every planar diagram is periodic, while

$$\tau = \{\{1, 2'\}, \{2, 3'\}, \dots, \{n, 1'\}\}$$

is periodic but not planar.

Write D_n^p for the set of such periodic diagrams, so that $D_n^z \subset D_n^p \subset D(V_n^n)$.

Proposition 3.3.2 notes that two concrete planar diagrams are isotopic if and only if they are realisations of the same diagram. This is not true in general for periodic diagrams. In particular there are non-isotopic embeddings of the identity diagram. The picture of τ^n obtained by composing pictures is an embedding of 1 not isotopic to the obvious embedding, for example. See appendix B for a fuller discussion.

Let D_n^{pc} denote the set of periodic isotopy classes of concrete diagrams associated to D_n^p (hence a set of periodic TL diagrams).

Because of the non-isotopic embedding possibility mentioned above the set D_n^{pc} is larger than the underlying set of diagrams, as defined by their serial realisations. It is possible (and useful) to have a serial realisation of isotopy classes, however. Note that embedded periodic diagrams may be drawn as period- n periodically repeating *planar* diagrams in the infinite frame (a string coming out of vertex 1 produces strings coming out of all vertices congruent to 1 modulo n , and so on), and hence as a subset of $J_{(n)}^S$:

$$D_n^{pc} \hookrightarrow J_{(n)}^S.$$

If we use *this* labelling in writing down the serial realisation of diagrams (and treat vertices on different ‘sheets’ as distinct, even if they are congruent), then we recover the situation that concrete periodic diagrams are isotopic if and only if they are realisations of the same diagram. (There are still infinitely many such diagrams however, even without beads. Our set of examples $\{\{\{1, m'\}\} \mid m \in \mathbb{Z}\}$ are all in D_n^{pc} with $n = 1$.)

The restriction of diagram composition (16) to D_n^p closes on KD_n^p . This product is amenable to deformation through the non-isotopic embeddings mentioned above (see [40, 16] for example). In particular let $D_n^{pc'}$ denote the augmentation of D_n^{pc} in case $S = \emptyset$ by classes of concrete diagrams including (non-crossing) non-contractible loops in the manner of $J'_{(n)}$. (NB, There is a drawing error in Fig.10 of [40]. This diagram should have 4 non-contractible loops, not 3.)

4 The blob algebra b_n and the achiral algebra b'_n

4.1 Two-coloured diagrams

Concrete TL diagrams may be thought of as partitions of the plane interior to the frame rectangle, with the lines being the boundaries of parts. The non-crossing rule means that these diagrams may be two-coloured (in the four colour theorem sense). For the sake of definiteness let us say that the part whose closure includes the interval on the frame between the vertices 1 and 2 is coloured black. It follows

that the part between 1' and 2' is also black, and that concatenation preserves this canonical colouring. It also follows that closed loops formed in concatenation may have either a black or a white interior (or to be more precise, immediate interior, since they may be nested).

Note that although colouring requires embedding, which is noncanonical, the number of loops of each colour formed in concatenation is invariant under plane isotopy (note that this is not true for the larger classes of Brauer isotopy). It follows that we can generalise the composition rule in (16) by generalising $k_{a,b}$.

By rescaling the generators U_i one can see that this generalisation is isomorphic to the ordinary case (excepting the specialisation in which one of the parameters is not invertible, which is not appropriate for the context of computation for Potts and vertex models, where the algebra has its origin [3]). However, we shall now show that it leads the way to some further rather more useful generalisations (in the spirit of the blob algebra [41] viewed as a generalisation of the type-B algebra of [54]).

4.2 Subalgebras and deformations

Let $J_n^B \subset J_n^z$ be the subset of TL diagrams that are (isotopic to concrete diagrams that are) invariant under reflection in a central vertical line. Putting aside for a moment any closed loops that might arise, this subset is obviously fixed under concatenation. That is, the concatenation of two concrete representatives of elements of J_n^B is a representative of an element of J_n^B (ignoring closed loops).

Remark: Indeed we could consider a version of J_n^B that is not a strict subset of J_n^z (a set whose elements are isotopy classes, where even classes containing symmetric elements include elements which are not concretely symmetric) but to be such that the elements are ‘symmetric isotopy’ classes - i.e. classes whose elements maintain exact symmetry. So long as we define our algebra composition without reference to pseudodiagrams this distinction is academic (but see section 7.2).

If n is odd then J_n^B is a rather uninteresting subset. If n is even, redefine canonical colouring to be that in which the part whose closure includes the central northern interval is coloured white. Note that within this subset the property that the concatenation of two diagrams forms a loop that *crosses* the centre line (indeed white, or black, loop that crosses) is invariant under isotopy. Thus we may deform the algebra spanned by these diagrams by generalising the scalar factor $k_{d_1 d_2}$ so that

$$k_{d_1 d_2} = \delta^{l_0} \delta_e^{l_w} \kappa^{l_b} \tag{19}$$

where $\delta, \delta_e, \kappa \in K$, l_0 is the number of (pairs of) noncrossing loops, l_w is the number of white crossing loops and l_b the number of black crossing loops.

Definition 4.2.1 *Let $b'_n(\delta, \delta_e, \kappa)$ denote the algebra which is KJ_n^B with product defined by (19).*

As usual the identity in this algebra is the pair partition \mathbb{I} . For any given $n = 2m$ let \mathbf{e}' denote the diagram corresponding to the pair partition differing from \mathbb{I} only

in $\{m, m + 1\}, \{m', m + 1'\}$, that is (in case $m = 3$):

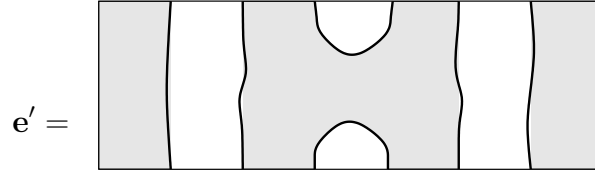

4.3 The unfolding map μ

Definition 4.3.1 *An ur-diagram is a TL diagram in which strings may end on the east or west edge of the rectangle as well as north and south.*

Recall that B_n denotes the set of blob diagrams. Given a blob diagram d , we may define a ur-diagram from it by deforming every string with a blob until an arc in the immediate neighbourhood of the blob is just on the outside of the western edge of the rectangle, and then discarding this arc. If we compose this ur-diagram with its mirror image in the western edge (NB, this is a well defined construct on isotopy classes) we have a left-right symmetric TL diagram. Let us call it $\mu(d)$. For example $\mu(e) = e'$.

Proposition 4.3.2 *The map $\mu : B_m \longrightarrow J_{2m}^z$ defined above is an injection, and the range is the set J_{2m}^B of left-right symmetric diagrams. \square*

(This generalises the combinatorial map described in [11].)

Proposition 4.3.3 *The map μ extends to an algebra homomorphism, so that the algebra $b'_{2m}(\delta, \delta_e, \kappa)$ is isomorphic to the blob algebra $b_m(\delta, \delta_e, \kappa)$.*

Proof: We need to check that $\mu(a)\mu(b) = \mu(ab)$, where a, b are blob diagrams. If we consider ab as a concatenation, without (for a moment) imposing the blob relations, it can have two blobs on the same line, and it can have closed loops, with and without blobs. The map μ makes sense on such an ab , and commutes with concatenation. It is thus necessary to check that the imposition of the blob relations on ab produces the same factor as $k_{\mu(a), \mu(b)}$. If two blobs come together we use the blob relation $ee = \delta_e e$ from (18). The image under μ is (locally):

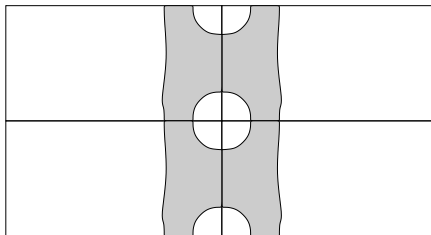

which has one white loop, so $k_{\mu(a), \mu(b)} = \delta_e$ as required. A decorated loop is replaced by a factor κ in the blob algebra $b_m(\delta, \delta_e, \kappa)$ (cf. section 3.4), and passes to a black loop under μ . From (19) this again gives a factor κ . An undecorated loop (δ in the blob algebra) passes to a pair of off-axis loops under μ . \square

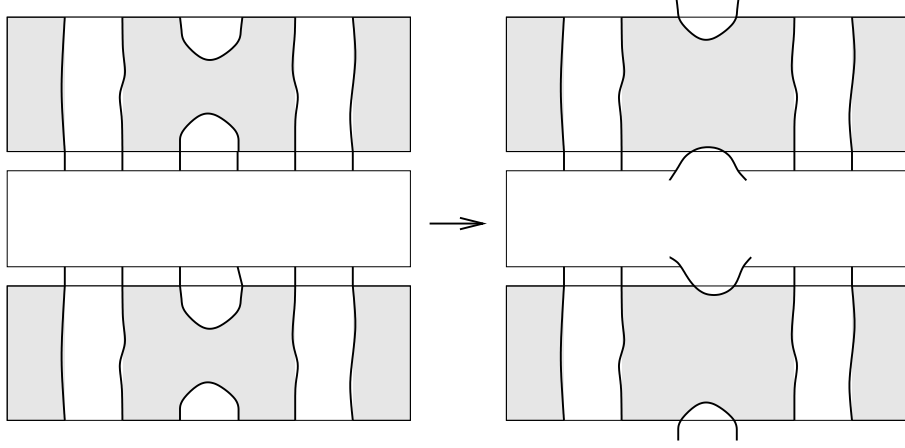

Figure 2: Removing the central cup and cap.

5 Recollement and b'_n representation theory

Suppose that δ_e is invertible. Then the subset of J_{2m}^B consisting of symmetric diagrams in which the inner central ‘cup’ and ‘cap’ appear (i.e. diagrams that contain $\{m, m+1\}, \{m', m+1'\}$ as pair partitions) are a basis for a subalgebra of b'_{2m} . Since $\mathbf{e}'\mathbf{e}' = \delta_e\mathbf{e}'$ then $\frac{1}{\delta_e}\mathbf{e}'$ is idempotent, and is the unit in this subalgebra. It may be identified with the idempotent subalgebra $b''_{2m} = \frac{\mathbf{e}'}{\delta_e}b'_{2m}(\delta, \delta_e, \kappa)\frac{\mathbf{e}'}{\delta_e}$. Since a white loop appears automatically in every composition in this algebra, a better basis is the set J_{2m}^{Be} of such diagrams each multiplied by $\frac{1}{\delta_e}$. Then if no *other* loops appear in composition the product of two basis elements is another basis element.

Remark: Actually the algebras $b'_{2m}(\delta, \delta_e, \kappa)$ and $b'_{2m}(\delta, \alpha\delta_e, \alpha\kappa)$ are readily seen to be isomorphic for any invertible α (consider the isomorphic [37] presentational form (2-7), for example). It is thus possible to replace $b'_{2m}(\delta, \delta_e, \kappa)$ with $b'_{2m}(\delta, 1, \delta_e^{-1}\kappa)$ without loss of generality.

It will be evident from figure 2 that there is a set map

$$\rho^- : J_{2m}^{Be} \rightarrow J_{2m-2}^B$$

defined by simply removing the central upper ‘cup’ and lower ‘cap’ from the diagram underlying each basis element (and discarding the factor $\frac{1}{\delta_e}$). Indeed ρ^- is a bijection. We next extend this to an algebra map.

Proposition 5.0.4 *The map ρ^- extends K -linearly to an algebra isomorphism*

$$\rho^- : \frac{\mathbf{e}'}{\delta_e}b'_{2m}(\delta, \delta_e, \kappa)\frac{\mathbf{e}'}{\delta_e} \longrightarrow b'_{2m-2}(\delta, \kappa, \delta_e).$$

Proof: Consider ρ^- extended in the obvious way to pseudodiagrams. Concatenation of diagrams may be thought of as the first step in computing composition on both sides, and commutes with ρ^- (given the automatic cancellation of one loop with a normalising factor on the domain side). The final step is interpretation of the

pseudodiagram as a scalar multiple of the underlying basis element. This differs on the range side, precisely in that the colour assigned to each loop is reversed (by the cup/cap removal). ¹ This difference is thus itself reversed by exchanging the roles of δ_e and κ .

□

For example, let a be a basis element with underlying diagram as shown in the upper left of:

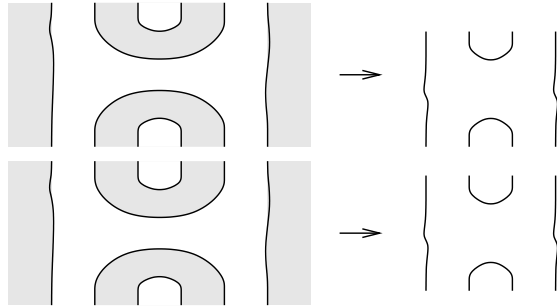

We see that the product on the left is $a.a = \kappa a$ (taking account of factors of $\frac{1}{\delta_e}$). The image $\rho(a)$ is shown on the right, together with $\rho(a).\rho(a) = \tilde{\delta}_e \rho(a)$ (writing $\tilde{\delta}_e$ for the δ_e parameter in the image). Thus in order for $\rho(a.a) = \rho(a).\rho(a)$ we require $\tilde{\delta}_e = \kappa$.

On the other hand, with the basis elements indicated on the left in:

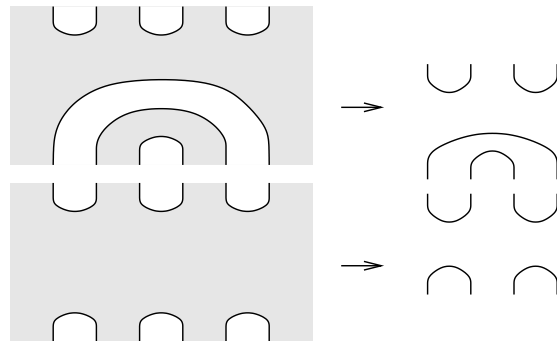

we have $b.c = \delta_e c$, while on the left $\rho(b).\rho(c) = \tilde{\kappa} \rho(c)$. So we require $\tilde{\kappa} = \delta_e$, as stated.

For the moment let us use the shorthand A_m for $b'_{2m}(\delta, \delta_e, \kappa)$ and B_m for $b'_{2m}(\delta, \kappa, \delta_e)$, and Λ_m^A for an index set for simple modules of A_m (and similarly for B_m). We may now bring to bear the recollement part of the machinery described in [12] (summarized in section 2). In particular note that Proposition 5.0.4 tells us the following.

Theorem 5.0.5 *The category of left $b'_{2m-2}(\delta, \delta_e, \kappa)$ -modules is fully embedded in the category of left $b'_{2m}(\delta, \kappa, \delta_e)$ -modules. □*

¹Consider the colouring of a pseudodiagram on the domain side of ρ^- , which determines the scalar factors there. If we think of trying to keep this colouring, then once the cup and cap are removed the colour of the upper central interval (as used to determine scalar factors) is black, not white. Obviously then, *all* colours are inverted, compared to what they would normally be on the target side. Thus in particular central loops which would properly be white will be black, and vice versa. Thus the map ρ^- reverses all colours and will not extend naively to an algebra homomorphism. Swapping the colours exchanges the roles of δ_e and κ , so we can fix this by defining the extension as above for basis elements, but which maps scalar coefficients by exchanging the roles of δ_e and κ .

It follows (via proposition 2.0.1) that the simple modules S of the latter *not* obeying $\mathbf{e}'S = 0$ may be indexed by Λ_{m-1}^B . The simple modules obeying $\mathbf{e}'S = 0$ are also simple modules of the quotient $A_m/A_m\mathbf{e}'A_m$, but it is easy to see that this has precisely one simple module (since $A_m\mathbf{e}'A_m$ contains every diagram with fewer than $2m$ propagating lines).

In this way we derive the (well known) index set for simple modules of A_m . We also derive some striking results relating the homomorphisms between standard modules for A_m and B_{m-1} which, while not revealing any homomorphisms which were not already known, do reveal a layer of symmetry in the organisation of these homomorphisms which has not been noted before. This structure is not needed in the analysis of the blob algebra's representation theory, but it raises the very intriguing possibility of similar symmetries in (affine) Hecke algebra representation theory. We will discuss this further elsewhere.

5.1 The b_n version

With the benefit of hindsight we see that the recollement can be invoked directly in b_n . Let B'_n be the subset of B_n consisting of elements in which both the string containing vertex 1 and that containing vertex $1'$ are decorated (of course this could be the same string). Let $B_n^e = \{\frac{1}{\delta_e}d \mid d \in B'_n\} \subset b_n$.

Define a map

$$\rho_1 : B_n^e \longrightarrow B_{n-1} \quad (20)$$

as follows. For $d \in B'_n$, consider the region of d with the western edge in its closure: we have a sequence of one or more decorated lines reading clockwise around this region, starting from the vertex 1 (ignore the undecorated ones). This sequence is of the general form $\{1, i_1\}, \{i_2, i_3\}, \dots, \{i_l, 1'\}$ (some possibly primed vertices i_1, \dots, i_l), or simply $\{1, 1'\}$. In the latter case, simply erase the (decorated) line $\{1, 1'\}$. Otherwise, erase the sequence and replace with decorated lines $\{i_1, i_2\}, \dots, \{i_{l-1}, i_l\}$. After suitable renumbering we have an element of B_{n-1} . This is $\rho_1(\frac{1}{\delta_e}d)$.

The map is illustrated by the following example:

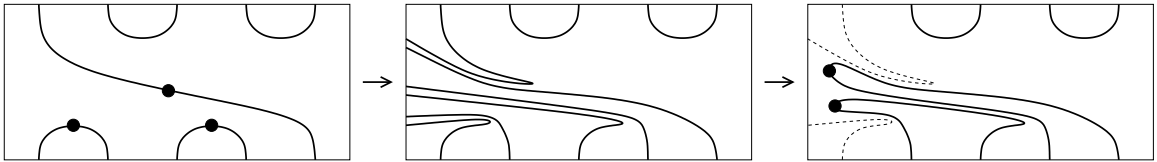

It will be evident that this map is a bijection.

Proposition 5.1.1 *The map ρ_1 extends K -linearly to an algebra isomorphism from the subalgebra b_n^e of $b_n(\delta, \delta_e, \kappa)$ spanned by B_n^e (with unit $\frac{1}{\delta_e}e$) to $b_{n-1}(\delta, \kappa, \delta_e)$. That is, ρ_1 is an algebra isomorphism with δ_e and κ interchanged.*

Proof: Consider Proposition 4.3.3 and Proposition 5.0.4. A short manipulation of diagrams (in the diagram algebra sense) confirms that the following diagram is commutative:

$$\begin{array}{ccc} b_n^e & \xrightarrow{\mu} & b_{2n}'' \\ \rho_1 \downarrow & & \downarrow \rho^- \\ b_{n-1} & \xrightarrow{\mu} & b_{2n-2}' \end{array}$$

for the appropriate parameter values. \square

The parameter change can be seen directly by considering multiplications in low n cases. For example:

(21)

To implement the proposed normalisation, let us call the top left diagram d_1 and the bottom left d_2 . Then on the left, implementing the normalisation, we want to consider $\frac{d_1 d_2}{\delta_e \delta_e} = \frac{\delta_e^3}{\delta_e^2} e U_2 U_4 = \delta_e^2 \frac{e U_2 U_4}{\delta_e}$. The figure shows that the left-hand side of this identity passes to $\kappa^2 U_1 U_3$ under ρ_1 , while the right-hand side passes directly to $\delta_e^2 U_1 U_3$. Here we see that, allowing for the normalisation of the first blob as an idempotent, on the left we pick up a factor δ_e^2 , and on the right a factor κ^2 . Meanwhile

(22)

has κ^2 on the left but δ_e^2 on the right.

6 Symplectic blob algebras

In this section we define several new algebras with the same flavour as b_n , and relate them to other algebras studied in the literature (cf. [49, 48]).

The first step is to define an appropriate class of pseudodiagrams, which compose by concatenation. Then we define a reduction of pseudodiagrams into scalar multiples of basic diagrams, so that composition reduces to an algebra multiplication.

6.1 Pseudodiagram categories

A TL *pseudodiagram* is a TL diagram possibly including closed loops. NB, loops cannot move isotopically over lines, so the set of (n, m) TL pseudodiagrams is larger than the subset of $D^\circ(V_m^n)$ with no beads.

Definition 6.1.1 [42, §2.3] *A (left) blob pseudodiagram is a TL pseudodiagram in which any left 0-covered arc may be decorated with a (left-)blob.*

There is a corresponding notion of right blob pseudodiagrams. A *left-right blob pseudodiagram* is a pseudodiagram which may have left and right-blob decorations, so long as every decorated arc may be deformed to touch its appropriate edge *simultaneously*. Write $\mathcal{H}(n, m)$ for the set of (n, m) -pseudodiagrams of this kind.

Provided they have the right number of vertices, these planar pseudodiagrams may be composed by extending the usual diagram concatenation (14). That is, concatenate concrete representations to give a concrete representative of the composite.

Lemma 6.1.2 *This composite is well defined (i.e. independent of the choice of representatives), associative and unital.*

Proof: The argument of Proposition 3.1.2 is not affected by the need to take account of isotopy classes distinguished by the embedding of closed loops. \square

Further

Proposition 6.1.3 *The composition of an (n, l) - and an (l, m) -pseudodiagram of the same type (ordinary, blob, left-right blob) is an (n, m) -pseudodiagram of that type. For each type the triple $(\mathbb{N}, \mathcal{H}, \circ)$ is a category, where $\mathcal{H}(n, m)$ is the set of morphisms for $n, m \in \mathbb{N}$.*

Note that there are unboundedly many pseudodiagrams of each type. Various features can appear (repeatedly) in pseudodiagrams, such as:

- (δ) undecorated loops;
- (δ_L, δ_R) consecutive runs of two left or right-blobs on the same arc (LL or RR);
- (κ_L, κ_R) loops decorated with a left or right-blob;
- (κ_{LR}) loops decorated with a left and a right-blob (NB, LRLR sequences are not possible on loops, so it is always possible to arrange blobs on loops into at most two same-type runs);
- (k_L) in a pseudodiagram with unique propagating line; this line can have LRL (resp. RLR) sequences on it.

It will be convenient to be able to refer to these features by the set of shorthand names indicated: $P_B := \{\delta, \delta_L, \delta_R, \kappa_L, \kappa_R, \kappa_{LR}, k_L\}$.

Proposition 6.1.4 *For given (n, m) , there are only finitely many diagrams with none of the features in P_B .*

Proof: Note that there are only finitely many underlying (undecorated) TL shapes possible, since all possible decorated loops are excluded. Then only finitely many decorations of the lines in these loop free shapes remain. \square

For example in case $(1, 1)$ every diagram has underlying TL diagram with just one string. The R, L -word on this string is one of $\{\emptyset, L, R, LR, RL\}$.

Definition 6.1.5 *A left-right blob diagram is a pseudodiagram in which none of the features above occur. The set of left-right blob diagrams with m vertices on the northern edge and m vertices on the southern edge is denoted $B_m^{x'}$.*

This set $B_m^{x'}$ is thus the set of diagrams whose underlying TL diagram has no loops, and where each western exposed line may be decorated with at most one left blob, and each eastern exposed line may be decorated with at most one right blob, subject

to the condition that it must be possible to deform each blob to its appropriate edge simultaneously without lines crossing. Each diagram has a representation as a pair partition with decorations, much as in the b_n case except that decorations R and even LR and RL may be possible. For example

$$\{\{1, 2\}_{LR}, \{1', 2'\}_{LR}\} \in B_2^{x'}$$

More generally, focusing on L -decorated pairs, the simultaneous deformation requirement gives the following.

Proposition 6.1.6 *If $d \in B_m^{x'}$ and $i, j \in \{1, \dots, m\}$ then:*

$(i, j)_{LR}$ a pair part in d implies $i < j$ are the two largest unprimed numbers in the list of L -decorated pairs;

$(i, j')_{LR}$ or $(i, j')_{RL}$ a pair part in d implies i (respectively j') is the largest unprimed (respectively primed) number in the list of L -decorated pairs;

$(i', j')_{LR}$ a pair part in d implies $i < j$ are the two largest primed numbers in the list of L -decorated pairs.

Thus

Corollary 6.1.7 *At most two R s can appear in the list of L -decorated pairs in $d \in B_m^{x'}$, and then precisely in the situation of the following figure.*

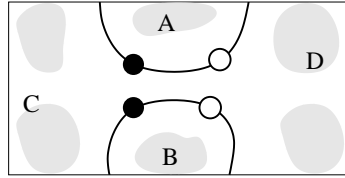

(23)

Note that in pictures we use a solid blob for L and \circ for R .

Definition 6.1.8 *The set B_m^x is obtained from $B_m^{x'}$ by discarding the diagrams of the type shown in (23).*

6.2 Initial pseudodiagram reduction

Let d be a pseudodiagram. Write

$$d \overset{x}{\rightsquigarrow} d' \quad (x \in P_B)$$

if d, d' differ by removal of one corresponding loop or, respectively, L, R -string replacement: $LL \rightsquigarrow L, RR \rightsquigarrow R, LRL \rightsquigarrow L, RLR \rightsquigarrow R$.

It will be evident that all maximal chains of relations $\overset{\delta}{\rightsquigarrow}$ starting from d end in a diagram with no δ -loops, and are of the same length — call this length $\#_{\delta}(d)$; and that $\#_{\delta_L}(d), \#_{\delta_R}(d)$ may be defined similarly. Indeed

Proposition 6.2.1 *For any d there is always a chain of relations, with each relation some $\overset{x}{\rightsquigarrow}$ ($x \in P_B$), ending in a diagram with none of the identified features. There are in general multiple such chains from d , but every one ends in the same ‘reduced’ diagram — call it $r(d)$. Each such chain for d has the same number of links of the form $\overset{x}{\rightsquigarrow}$ for given $x \in P_B$.*

This number of links defines $\#_x(d)$ for each $x \in P_B$.

Proof: Note that the reductions are of two types: those that shorten the sequence of decorations on some arc of some line; and those that remove a loop. Both types are localised to individual lines (leaving all other structure unchanged), so we may talk of individual lines as being ‘locally’ reduced. Note also that loop removals only apply to loops that are locally reduced. Thus we may consider the reduction of each individual line. On each line we have a simple Bergman diamond [5] for the reduction of sequences of Ls and Rs. The only ambiguity is the reduction of LRLR to LR via LRL or RLR replacement, but both of these has $x = k_L$.

Once line-local reductions are complete, the loop removal process is immediate. \square

6.3 Towards finite and localisable algebras

Note that if $\#(a)$ is the number of occurrences of any given one of the features P_B in pseudodiagram a , then

$$\#(ab) \geq \#(a) + \#(b)$$

With this in mind, we can set out to define a finite dimensional algebra of diagrams (with fixed number of northern and southern vertices) by applying a quotient rule which equivalences a pseudodiagram with some such feature with a scalar multiple of the same diagram but with this feature excised or replaced as in $\overset{x}{\rightsquigarrow}$. Thus

$$LL = \delta_L L \tag{24}$$

$$LRL = k_L L \tag{25}$$

and so on, replacing each feature in P_B with a correspondingly named scalar:

$$d = k_d r(d) \tag{26}$$

where $k_d = \prod_{x \in P_B} x^{\#_x(d)}$. (Note that this is not a unique finitising procedure — for example we could omit the excision of $RLLR$, to leave a slightly larger but still finite quotient.)

The set $B_m^{x'}$ is a basis for the proposed finite-dimensional quotient algebra. To see that this quotient is internally consistent note that composition proceeds by concatenation to produce a pseudodiagram, which is then reduced using the relations. This reduction is consistent by Proposition 6.2.1.

Ab initio one might try to assign a different scalar parameter to the given LRL and RLR reductions, but they are related by commuting diagram:

$$\begin{array}{ccc}
 & LRLR & \\
 \swarrow & & \searrow \\
 k_L LR & \xlongequal{\quad RLR = k_R R \quad} & k_R LR
 \end{array}$$

Note that it is not possible to reduce the occurrence of LRL (or RLR) in a loop using k_L ($= k_R$) since this requires that the LRL reside on the only propagating line, so there is no return route to complete the loop. Indeed k_L never occurs in even index (even m) algebras, while κ_{LR} *only* occurs in even index algebras (no

propagating line can pass either to the left or to the right of the loop). It will turn out to be appropriate to set

$$\kappa_{LR} = \kappa_L \tag{27}$$

as can thus be done without loss of generality.

At this stage we define algebra $b_m^{x'}(\delta, \delta_L, \delta_R, \kappa_L, \kappa_R, \kappa_{LR})$ to be the quotient of the linear extension of the pseudodiagram composition by the relations (24), (25) and so on associated to the $\overset{x}{\rightsquigarrow}$ relations. The following is clear.

Proposition 6.3.1 *There is an algebra monomorphism*

$$b_m(\delta, \delta_L, \kappa_L) \hookrightarrow b_m^{x'}(\delta, \delta_L, \delta_R, \kappa_L, \kappa_R, \kappa_{LR})$$

that takes $e \mapsto L_1$. \square

We want to define an algebra (the *symplectic blob algebra*) that will be the quotient of $b_m^{x'}$ by some small set of further relations, chosen so as to make the representation theory of the algebra tractable by localisability. (These relations will also turn out to make contact with some other interesting algebras; see section 7.) That is, following the remarks in section 5.1 we may determine the structure of such an algebra at level m by constructing an idempotent subalgebra isomorphic to some known algebra (i.e. some version of the level $m - 1$ algebra, known by inductive hypothesis) — the localisation of the algebra under consideration.

Before passing to a localisable quotient, note that $b_n^{x'}$ is a quotient of the affine- C Hecke algebra defined in section 1.1:

Proposition 6.3.2 *The map $u_i \mapsto U_i$ ($n > i > 0$), $u_0 \mapsto e$ (left-blob), $u_n \mapsto f$ (right-blob), extends to an algebra homomorphism ϕ from $T(\hat{C}_n)(q_0, q_1, q_x)$ to $b_n^{x'}$ in case $q = q_1$, $\delta_L = q_0 + q_0^{-1}$, $\delta_R = q_x + q_x^{-1}$, $\kappa_L = \frac{q_0^2 + q^2}{q_0 q}$, and $\kappa_R = \frac{q_x^2 + q^2}{q_x q}$.*

Proof: The relation checking is largely routine. Note from (1) that $\phi(u_1 u_0 u_1 - \frac{q_0^2 + q_1^2}{q_0 q_1} u_1)$ vanishing is sufficient to ensure $\phi(E_{B_2}) = \phi(u_0(u_1 u_0 u_1 - \frac{q_0^2 + q_1^2}{q_0 q_1} u_1)) = 0$, and similarly with u_0, q_0 replaced by u_n, q_x . \square

This is closely analogous to the connection between the blob algebra and type- B Hecke algebra (Proposition 1.1.1), which has allowed the localisability of the *blob* to be used to investigate the representation theory of that Hecke algebra [11].

6.4 Combinatorial localisation

By analogy with section 5.1, we may form the subset $B_m^{x'e}$ of diagrams (normalised by $1/\delta_e = 1/\delta_L$ as before) in which the string(s) involving vertices 1 and $1'$ are decorated (with L).

The set B_m^{xe} is the subset of $B_m^{x'e}$ whose underlying diagrams are elements of B_m^x .

Our relations imply that this subset $B_m^{x'e}$ spans a subalgebra. The question is: *How do we construct an isomorphism between this subalgebra (or a 'large' quotient) and the algebra at level $m - 1$?* (Note that this choice of idempotent subalgebra breaks the left-right symmetry of the algebra — so there is a corresponding R -based formulation.)

To address this we first construct set maps between these algebras' basis diagrams.

Definition 6.4.1 Let $\mathcal{H}(m, m)^e$ denote the subset of $\mathcal{H}(m, m)$ in which the string(s) involving vertices 1 and 1' are L -decorated, and $\mathcal{H}_o(m, m)$ the subset with no loops and no multiple L -decorations on the same segment, and $\mathcal{H}_o(m, m)^e = \mathcal{H}_o(m, m) \cap \mathcal{H}(m, m)^e$.

Let $\tilde{\rho}$ denote the direct extension of the ρ_1 map (20) for b_n to $B_m^{x'e}$. That is

$$\tilde{\rho} : B_m^{x'e} \rightarrow \mathcal{H}(m-1, m-1)$$

Examples:

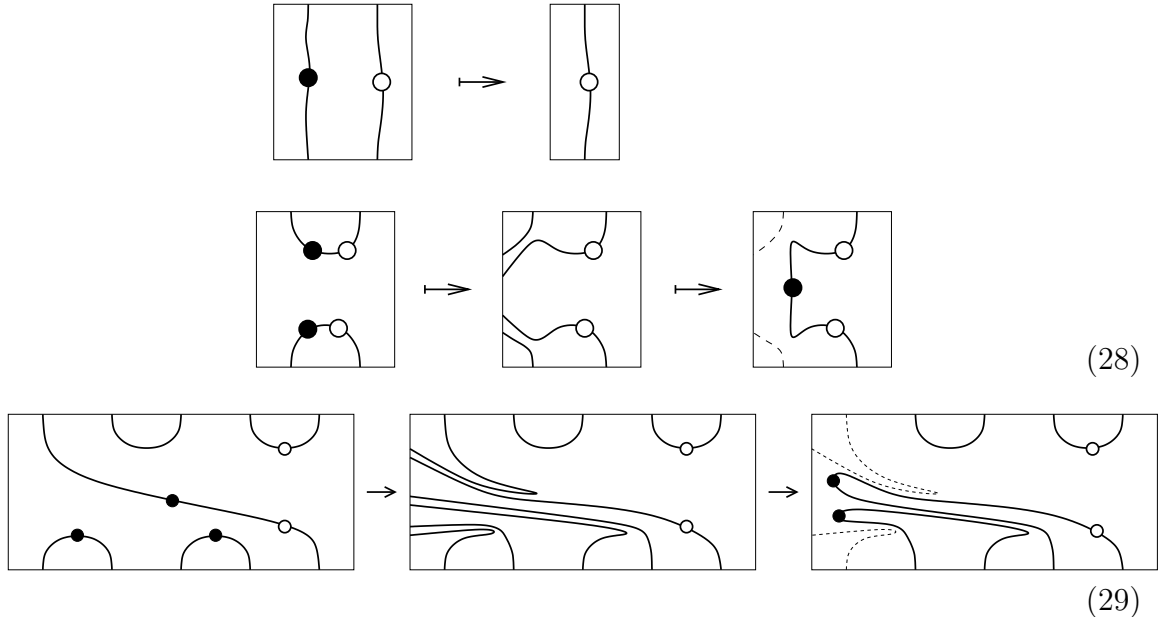

Note that the range is not $B_{m-1}^{x'}$, because segments with decoration RLR are possible, as (28) illustrates.

Definition 6.4.2 Let

$$\rho^* : B_{m-1}^x \rightarrow \left\{ \frac{1}{\delta_L} p \mid p \in \mathcal{H}(m, m)^e \right\}$$

be defined as follows. If d has no L decorations then it maps to the same diagram but with a propagating L -decorated line on the left. Otherwise deform all blobs to just outside the western edge; cut the blobs off — so some positive even number of lines now end at the western edge; deform the top and bottom-most of these lines so that they end on the top and bottom edge respectively; L -decorate these lines; and reclose the remaining western endpoints with L -decorated arcs in adjacent pairs in the only possible way.

Proposition 6.4.3 The map $\tilde{\rho}$ restricts to a bijection:

$$\tilde{\rho} : B_m^{xe} \rightarrow B_{m-1}^x$$

with inverse ρ^* .

Proof: First note that if d has $\{1, 1'\}$ as L -decorated pair the result $\rho^*(\tilde{\rho}(d)) = d$ is clear from the definitions.

For $d \in B_m^{xe}$ let $\{1, i_1\}, \dots, \{i_l, 1'\}$ be the L -decorated pairs. By Corollary 6.1.7 at most one of these is R -decorated — $\{i_r, i_{r+1}\}$ say. Then $\tilde{\rho}(d)$ has the same (suitably relabeled) non- L -decorated pairs, and the L -decorated pairs $\{i_1, i_2\}, \dots, \{i_{l-1}, i_l\}$; with the further R -decoration (if any) on $\{i_{r-1}, i_r\}$ or $\{i_{r+1}, i_{r+2}\}$ as appropriate:

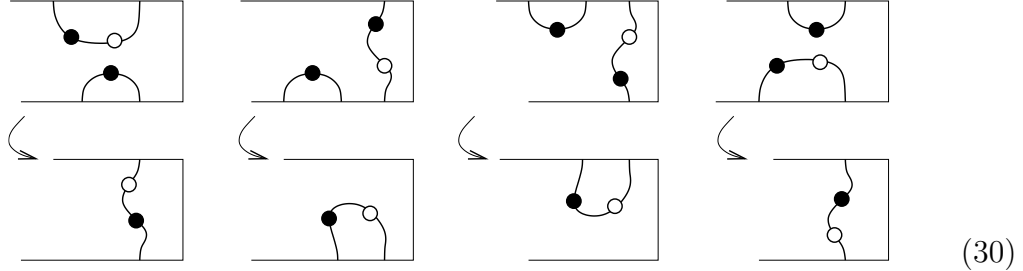

Note that this establishes that $\tilde{\rho}(B_m^{xe}) \subseteq B_{m-1}^x$.

For $d \in B_{m-1}^x$ let $\{i_1, i_2\}, \dots, \{i_{l-1}, i_l\}$ be the list of L -decorated pairs. As before there is at most one R -decoration in this list, on $\{i_{r-1}, i_r\}$ say. Then $\rho^*(d)$ has the same non- L -decorated pairs as d , and L -decorated pairs $\{1, i_1\}, \dots, \{i_l, 1'\}$. It has at most one further R , on $\{i_{r-2}, i_{r-1}\}$ or $\{i_r, i_{r+1}\}$ as appropriate. Note that it follows that $\rho^*(B_{m-1}^x) \subseteq B_m^{xe}$.

Considering $\rho^*(\tilde{\rho}(d))$ then, the lists of L -decorated (and undecorated) pairs are manifestly restored. The location of the R -decoration (if any) in the L -decorated list may be seen to be restored by considering the four cases in Proposition 6.1.6 (illustrated above).

A similar argument shows the right inverse property. \square

Remark: Map $\tilde{\rho}$ extends in the obvious way to a map from $\mathcal{H}(m, m)^e$ to $\mathcal{H}(m-1, m-1)$ — it is only necessary further to specify that every blob deformation (in the sense of the illustration to the definition of ρ_1) that is not on a closed loop, except the lowest such, passes to the north of every blob deformation that is — see the figure below for an illustration.

Map ρ^* extends in the obvious way to the domain $\mathcal{H}(m-1, m-1)$, provided again that closed loops are unambiguously treated in the deformation process — let us say that they are deemed to congregate in the north-west.

The extended map $\tilde{\rho}$ is illustrated by the following example:

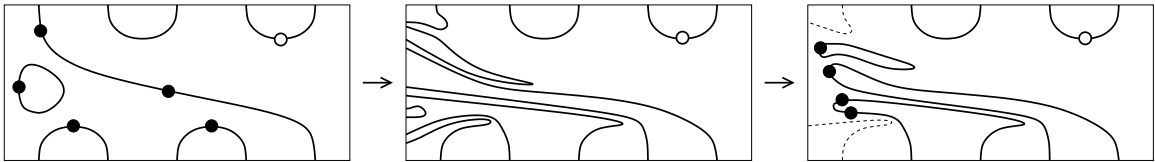

Note that we have

$$\mathcal{H}(m, m)^e \xrightarrow{\tilde{\rho}} \mathcal{H}(m-1, m-1) \xrightarrow{\rho^*} \mathcal{H}(m, m)^e$$

but the two maps are not inverse with this domain and range, because of the necessarily arbitrary choice of treatment of closed loops. With the choice specified, $\rho^*(\tilde{\rho}(d))$ is similar to d , except that all ‘extra’ blobs are gathered on the top left line, regardless of where they were in d .

6.5 Algebra localisation and the symplectic blob algebra

The obvious candidate to construct our algebra isomorphism is $\tilde{\rho}$ on $B_m^{x'e}$. But note that the range is not $B_{m-1}^{x'}$ here, and this is not a bijection. Consider the examples in (28) (neglecting the $1/\delta_e$ factor for the moment): Note that the right hand side of the bottom example in (28) is k_L times the right hand side of the upper example (by the RLR relation). Thus if we want to have an isomorphism we must require the same of the left hand sides, that is, we must impose a further quotient relation. This means in particular that we eliminate the diagram with two double-decorated lines from the basis.

Definition 6.5.1 *The ‘topological’ quotient of $b_m^{x'}(\delta, \delta_L, \delta_R, \kappa_L, \kappa_R, \kappa_{LR})$ is defined by*

$$\kappa_{LR} \quad \left[\text{Diagram with two vertical lines, black dot on left, white circle on right, shaded regions A, B, C, D} \right] = \left[\text{Diagram with two vertical lines, black dot and white circle connected by arcs, shaded regions A, B, C, D} \right] \quad (31)$$

Here each labelled shaded area is shorthand for a certain subdiagram. Thus each diagram restricts to the same subdiagram in the shaded region marked A (resp. B, C, D), but (31) represents an identity for each such arrangement. (Note that in C and D there must be a route for the adjacent blob to the edge, hence no propagating lines. Indeed there are no propagating lines at all on the right hand side)

Definition 6.5.2 *Define the symplectic blob algebra $b_m^x(\delta, \delta_L, \delta_R, \kappa_L, \kappa_R, \kappa_{LR})$ to be the quotient of $b_m^{x'}(\delta, \delta_L, \delta_R, \kappa_L, \kappa_R, \kappa_{LR})$ by the additional set of relations (31).*

Proposition 6.5.3 *The set B_m^x is a basis for $b_m^x(\delta, \delta_L, \delta_R, \kappa_L, \kappa_R, \kappa_{LR})$.*

Proof: We use Bergman’s diamond lemma [5].

Let us define the *height* of a (pseudo)diagram to be the sum of the number of loops and the number of decorations. We observe that all the nontrivial relations alter the height of a diagram. This is easily checked except in the case of the topological relation, in which case two of the decorations are removed. The vertical edges shown on the left hand diagram D_0 in Definition 6.5.1 are the only vertical edges in D_0 , and thus these edges can only participate in a total of one loop in a product $D_1 D_0 D_2$ containing D_0 . This means that at most one loop can be deleted when applying the topological relation to reduce the number of decorations, and thus that the height decreases by at least $2 - 1 = 1$.

We may now choose a semigroup order, $<$, on the corresponding free diagram algebra in such a way that smaller diagrams have strictly smaller height. We aim to conclude that a minimal diagram in this sense is a basis element. To do so, we need to worry about inclusion ambiguities (of which there are none) and overlap ambiguities. (We are assuming familiarity with Bergman’s set-up.) Imagine that the diagrams shown in Definition 6.5.1 are sandwiched between other diagrams to the top and bottom in a triple product.

There is nothing to check for k_L -type relations, because they cannot occur in ‘even index’ algebras, which is where this problem arises.

The κ_L and κ_R relations cause no problem because they commute with the topological relation.

The δ_L and δ_R relations also commute with the topological relation, because they never remove the last L (respectively, R) decoration.

The δ relation is easy to deal with because it cannot interact with the topological relation, and thus the relations commute.

The only nontrivial case is the κ_{LR} relation:

Suppose the top of the right hand side of Definition 6.5.1 is part of a κ_{LR} -type loop. Then we have a choice: we can contract the κ_{LR} loop first and then apply the topological relation, or vice versa. The ambiguity is resolvable here, however, because the region A (plus whatever is just above it) can only be a disjoint collection of undecorated loops, so they can be deleted and then recreated anywhere in the diagram where they will not cause an intersection.

A similar case deals with the region B and a κ_{LR} loop at the bottom.

If there is a κ_{LR} feature on the left hand side, then there must be two such features on the right hand side, and a similar argument again applies.

According to Bergman’s diamond lemma, we can conclude that the minimal diagrams in this “height” sense are a basis, as desired. \square

Proposition 6.5.4 *Provided that $\delta_L = \delta_e$ is invertible, the map $\tilde{\rho}$ extends to an isomorphism*

$$e b_m^x(\delta, \delta_L, \delta_R, \kappa_L, \kappa_R, \kappa_{LR}) e \cong b_{m-1}^x(\delta, \kappa_L, \delta_R, \delta_L, \kappa_R, \kappa_{LR})$$

Proof: We have to check $\tilde{\rho}(d_1 d_2) = \tilde{\rho}(d_1) \tilde{\rho}(d_2)$. Composition on both sides begins with pseudodiagram concatenation — so it remains to check that pseudodiagram reduction is consistent. This is a routine ‘diagram chase’ similar to the blob case. The difference is that there are R s present — these largely play no role, except that the κ_{LR} reduction on the left becomes a k_L reduction on the right,

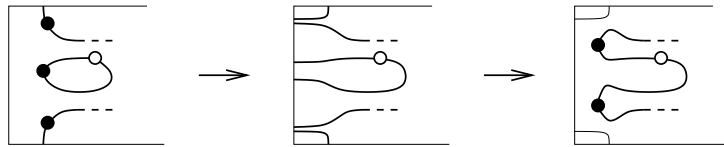

and vice versa (however note that these matters are already resolved by our identification of these parameters in (27)). \square

See (21) and (22) for diagrams exemplifying the parameter change. Also:

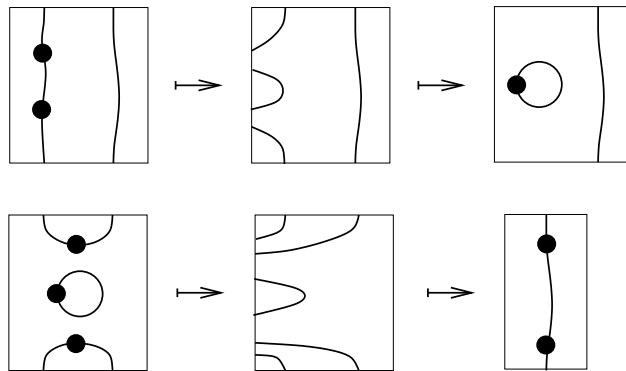

illustrating that δ_L and κ_L are swapped.

Note that b_m^x is a radical departure from the original blob algebra, in that the topological quotient mixes between diagrams with different numbers of ‘propagating lines’. This appears to deny us a powerful tool in representation theory (cf. [41]). However, we will determine the structure of this algebra by appealing to a slightly different realisation.

To reiterate: Just as the blob algebra is isomorphic to the 0-cover $m = 2$ contour algebra, so the idea of the east-west composite $m = 2$ contour algebra (that is the variation in which lines which are 0-covered to the east or the west may be decorated with a left (respectively right) blob) also turns out to include a rather interesting case. There are a couple of ways in which such an algebra can be defined. Firstly note that some lines, in some diagrams, are 0-covered both to east and to west. Then left and right-blobs can meet on such a line. In general we will consider them to be distinct, and even noncommuting on the line. Consider the case in which we disallow multiple decorations with the property that it is not possible to deform both the east leaning blob to the eastern edge and the west leaning blob to the western edge simultaneously.

7 Affine symmetric TL algebra

One reason why this algebra b_m^x is interesting is the existence of a doubled version of the *unfolding* map μ . As with μ on B_m , the western blobs in an element of B_m^x may again be used to map the diagram into left-right symmetric versions (so far still with eastern blobs, now with mirror images) about a reflection wall corresponding to the western edge. If we play the same game with eastern blobs we have another reflection wall corresponding to the eastern edge, which is thus *affine* in the affine reflection group sense [27]! Altogether we have a fundamental domain (as it were) between these two reflection walls, with a mirror image on each side (and then repeated reflections beyond). Obviously then, the mirror image on the right is a translate of that on the left and we have *periodicity*. Here is an example (the embossed letter ‘R’ added to the fundamental rectangle in this figure is only intended to emphasise the mirror images):

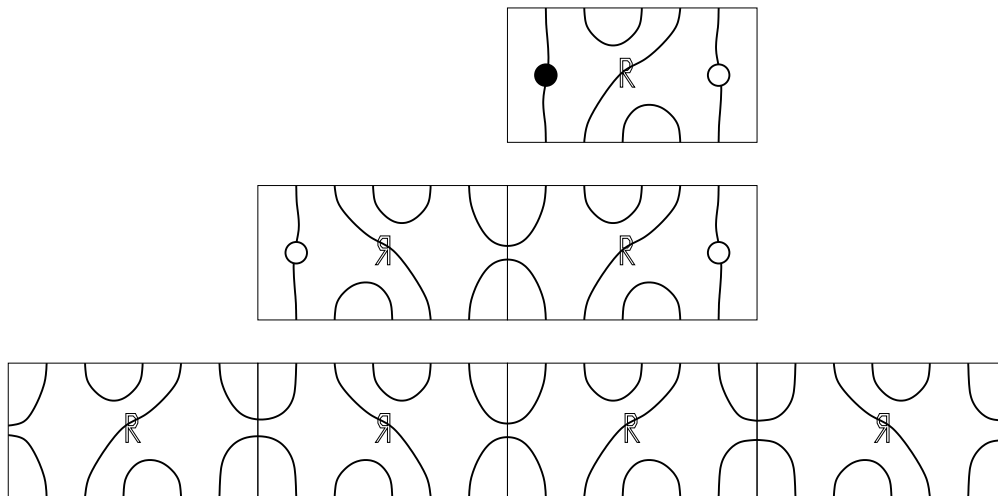

(Note as before that this is a well defined construct on isotopy classes.) We observe that the resultant diagram is an element of $D_{2m}^{pc'}$, the set of periodic TL diagrams with $2m$ vertices along each edge in the fundamental period (see §3.5). We denote by μ^x this unfolding map:

$$\mu^x : B_m^x \longrightarrow D_{2m}^{pc'}$$

7.1 On properties of the unfolding map μ^x

We can extend μ^x K -linearly into a map from the algebra b_m^x to $KD_{2m}^{pc'}$. It takes the generator U_i in that algebra to a product $U_i U_{-i}$ (in a suitable labelling) in $D_{2m}^{pc'}$, and so on. In other words we have a left-right symmetric subquotient-algebra of a *periodic* TL diagram algebra.

Here is an example, of μ^x mapping to the cylinder realisation, viewing the cylinder along the axis, so that it appears as an annulus:

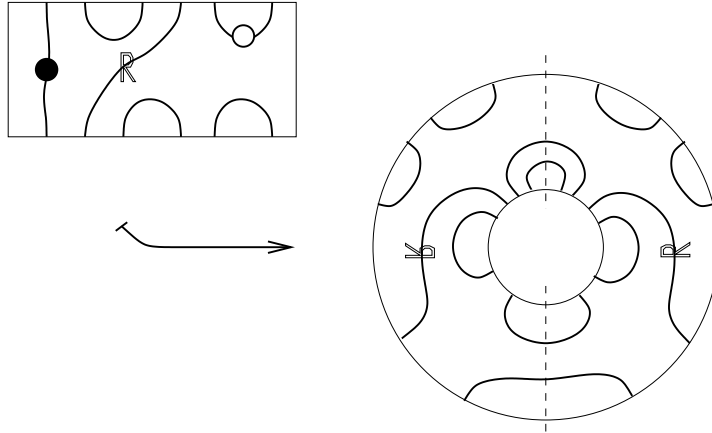

Definition 7.1.1 Let D_{2m}^ϕ denote the set of left-right symmetric periodic diagrams contained in $D_{2m}^{pc'}$. (NB, noncontractible loops are still possible in D_{2m}^ϕ .)

There is a subalgebra of the periodic algebra spanned by D_{2m}^ϕ . It will be evident from the illustration above that $\mu^x(B_m^x)$ lies in this set.

Note further that these diagrams can be two-coloured like ordinary TL diagrams. (Periodic diagrams with odd numbers of vertices cannot be two-coloured on the cylinder or annulus without a cohomology seam, but this need not concern us here.) For definiteness we fix that the region touching the interval of the northern edge (which becomes the *inner* edge in the annular realisation) astride the 0-reflection

line is coloured *white*. For example

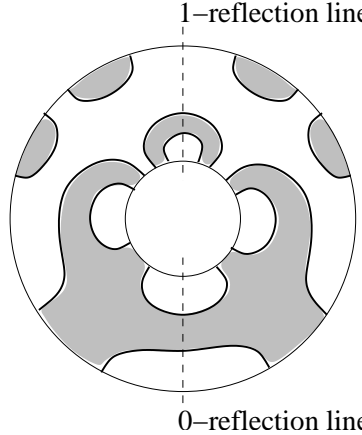

Note that there is a subset of these left-right symmetric periodic diagrams with the property that the induced colouring of the intervals of the southern edge coincides with that on the northern edge. (Note that this is a proper subset in general, since it is possible to draw a symmetric periodic diagram in which precisely one line crosses the reflection line.) Diagrams with this property are called *colouring composable* (CC) diagrams because, when they are concatenated in the usual way (top edge to bottom edge, or inner edge to outer edge in the annular realisation) the colouring we have specified gives colours that agree across the join. It follows that the set of colouring composable diagrams again spans a subalgebra. It will be evident that $\mu^x(B_m^x)$ lies in this set (since μ^x drags finite decorated segments of decorated lines out of the diagram, creating *pairs* of crossings of the reflection line).

To see that the image $\mu^x(B_m^x)$ generates a quotient of the corresponding subalgebra of the periodic algebra, we should explicitly consider the image in the set D_{2m}^ϕ of symmetric periodic diagrams described above.

Proposition 7.1.2 *The map $\mu^x : B_m^x \rightarrow D_{2m}^\phi$ is injective.*

Proof: The map is reversible at the point of deforming a blob out of the frame, so the issue is if isotopy on the target side can equivalence two diagrams. However no contractible loops are produced from diagrams in B_m^x , so no such isotopy can arise. \square

Note that this map is not surjective on arbitrary CC symmetric periodic diagrams, since the maximum number of noncontractible loops is 1 in the image. The quotients associated to the parameters k_L and κ_{LR} on the blob side both have the effect of replacing a pair of noncontractible loops with the factor κ_{LR} .

7.2 Periodic pseudodiagram reduction

Recall from section 3.2 that a periodic pseudodiagram is the generalisation of an ordinary pseudodiagram from a rectangular to a cylindrical geometry (or unboundedly wide rectangles with finite periodic repetition).

Here we will restrict to even period left-right symmetric colouring composable pseudodiagrams. (Periodic left-right symmetric is the same as affine symmetric, as

already noted.) Write CC_{2m} for the set of these pseudodiagrams with period $2m$. We will colour such that the central northern interval is white.

As usual these diagrams are isotopy classes of concrete diagrams. But as in section 4.2, having taken a subset we have the option of correspondingly strengthening the notion of isotopy. Here we consider isotopies that preserve the symmetry. (Note, then, that CC_{2m} is not the same thing as the subset of general periodic pseudodiagrams with symmetric representative elements, where a diagram with two contractible loops on either side of the reflection line is isotopic to one with two contractible loops both astride the reflection line.)

Composition on CC_{2m} is defined as before.

Proposition 7.2.1 *The following list of features of concrete pseudodiagrams are preserved by the CC_{2m} isotopy in this setting, and hence can be considered to appear (with well defined multiplicities) in these pseudodiagrams:*

- (δ) *symmetric pair of loops (one each side of the symmetry line — the 0-reflection line);*
- (δ'_L) *white loop astride the 0-reflection line;*
- (κ'_L) *black loop astride the 0-reflection line;*
- (δ'_R) *white (m even) (respectively black (m odd)) loop astride the 1-reflection line;*
- (κ'_R) *black (m even) (respectively white (m odd)) loop astride the 1-reflection line;*
- (κ') *pair of noncontractible loops. (Two such loops are ‘adjacent’ if they may be deformed to touch, and the pair is called black (respectively white) if one is on the black (respectively white) side of the partition formed by the other.) \square*

Let us write B_{2m}^ϕ for the subset of pseudodiagrams in CC_{2m} with *none* of these features. For given period n there are finitely many such pseudodiagrams.

Define a map

$$\nu : CC_{2m} \rightarrow D^o(V)|_{S=\{b,w\}}$$

(that is, $D^o(V)$ with two types of decoration) as follows. Given a diagram in CC_{2m} consider the ur-diagram which is the strip between the 0-reflection line on the left and the 1-reflection line on the right (so the affine reflection group orbit of this strip is the whole diagram). By the CC condition there are an even number of lines leaving the strip through the 0-reflection line (and similarly for the 1-reflection line). Thus the lines leaving the strip through the 0-reflection line may be collected into pairs, such that the two lines in a pair are consecutive on the reflection line. This means that they can be brought arbitrarily close together at the reflection line. Joining each such pair with a blob (and similarly with a white-blob at the 1-reflection line) we get an element of $D^o(V)$.

Note that ν is not injective on CC_{2m} . A diagram with two non-contractible loops and a (mirror) pair of contractible loops above them is mapped to the same element of $D^o(V)$ as a diagram with two non-contractible loops and a (mirror) pair of contractible loops below them.

Lemma 7.2.2 *The maps ν and μ^x induce a bijection between B_m^x and B_{2m}^ϕ .*

Proof: Firstly note that $\nu \circ \mu^x$ is the identity map on B_m^x (ν is the reverse of μ^x , which is injective).

Secondly, consider $d \in CC_{2m} \setminus B_{2m}^\phi$. It has at least one of the listed features. It is routine to check that each of these produces at least one contractible loop in $\nu(d)$. Thus $\nu(\mu^x(B_m^x) \setminus B_{2m}^\phi)$ does not intersect B_m^x . But by the previous paragraph $\nu(\mu^x(B_m^x) \setminus B_{2m}^\phi)$ is contained in B_m^x , so it is empty. Thus $\mu^x(B_m^x) \subseteq B_{2m}^\phi$.

Next we show that $\nu(B_{2m}^\phi) \subset B_m^x$. First consider $d \in \nu(B_{2m}^\phi)$ that does not have any non-contractible loops. Any line in d starting at the northern edge, say, and crossing the 0 or 1 line cannot be propagating, and will have a corresponding line starting at the northern or southern edge paired to it by the CC'ness of d . Thus no string in $\nu(d)$ has more than one blob on it, and thus $\nu(d) \in B_m^x$. If $d \in \nu(B_{2m}^\phi)$ does have a (necessarily unique) non-contractible loop, then this line under ν becomes part of the unique propagating line and is decorated by exactly one black and one white blob. All other blobs come from non-propagating lines combining in pairs as before.

It is easy to see that $\mu^x \circ \nu|_{B_{2m}^\phi}$ is the identity map. Thus ν is injective when restricted to B_{2m}^ϕ . Thus finally the two sets have the same cardinality. \square

Denote by $b_{2m}^\phi(\delta, \delta'_L, \delta'_R, \kappa'_L, \kappa'_R, \kappa')$ the quotient of the K -algebra spanned by CC_{2m} by the relations that each feature itemised in Proposition 7.2.1 may be removed at the cost of introducing a scalar factor as indicated in Proposition 7.2.1 in brackets (each such factor then appearing, note, as an argument to b_{2m}^ϕ).

Since all of the features of pseudodiagrams in Proposition 7.2.1 have multiplicity weakly increasing in composition we have

Proposition 7.2.3 *The affine symmetric TL algebra $b_{2m}^\phi(\delta, \delta'_L, \delta'_R, \kappa'_L, \kappa'_R, \kappa')$ has basis B_{2m}^ϕ .*

Proof: One uses Bergman's diamond lemma much as in Proposition 6.5.3. \square

Again this is not the only way to produce a finite rank quotient. For example κ' could be for the excision of black pairs only (see also [40]). However

Proposition 7.2.4 *The map μ^x extends to an algebra isomorphism*

$$\mu^x : b_m^x \longrightarrow b_{2m}^\phi$$

with the obvious identification of parameters.

Proof: Note from the construction that ν commutes with diagram composition, considered as a map from CC_{2m} to $D^o(V)$. It remains to show that the two different kinds of pseudodiagram reduction yield the same factors on each side. Applying ν to a diagram with two non-contractible loops will give a diagram with a loop with both types of decoration on it — thus we set $\kappa' = \kappa_{LR}$.

Applying ν to a diagram with a pair of contractible loops will give a diagram with an undecorated loop — reduction on either side gives a factor δ .

Applying ν to a diagram with a white loop astride the 0-line will give a diagram with a line with two left-blobs on it — thus we set $\delta'_L = \delta_L$.

Applying ν to a diagram with a black loop astride the 0-line will give a diagram with a loop with a left-blob on it — thus we set $\kappa'_L = \kappa_L$.

The loops astride the 1-line pass across similarly. \square

Remark: Note that $b_m^{x'}$ does not map injectively into b_{2m}^ϕ without the ‘topological’ quotient, since

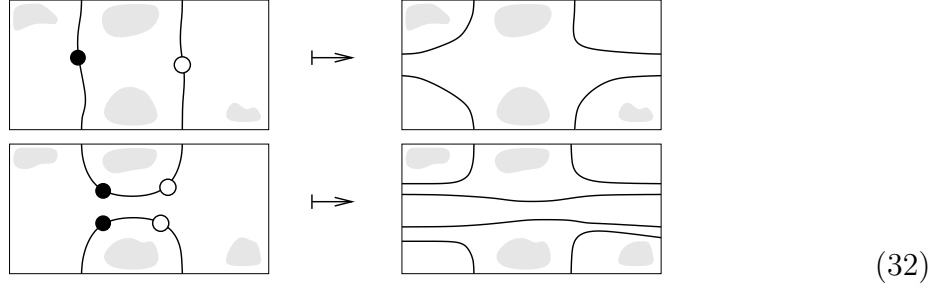

We will see that even before the quotient the affine symmetric subalgebra is not complicated by as many ‘infinities’ as the ordinary periodic TLA. We will also see that it is amenable to the same recollement treatment as the non-affine case above.

The claim is that the set of diagrams that contain a cup and cap astride the 0-reflection line is a subset that spans an (idempotent) subalgebra (a similar statement holds for the 1-reflection line). There is a bijective map into the set of all diagrams with one fewer vertex on each side obtained by simply removing this cup and cap. In order to elevate this to the status of an algebra homomorphism we will again have to take care with the parameters.

8 Representation theory of ASTLA

In what follows f corresponds to the right blob, in the way that e (or e') corresponds to the left blob:

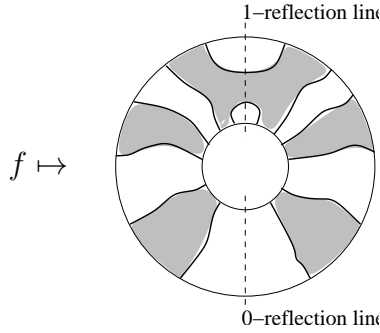

8.1 General and generic results

Assume that δ_L is invertible in K . Let $\rho' : D_{2m-2}^\phi \longrightarrow \frac{1}{\delta_L} D_{2m}^\phi \subset K D_{2m}^\phi$ denote the map that inserts a cup and cap astride the 0-reflection line and then rescales by $\frac{1}{\delta_L}$.

Note that the map ρ' is injective, with image the set of *all* (rescaled) diagrams in D_{2m}^ϕ with a cup and cap astride the 0-reflection line. Thus $\rho'(B_{2m-2}^\phi)$ spans the subalgebra $\frac{e'}{\delta_L} b_{2m}^\phi(\delta, \dots) \frac{e'}{\delta_L}$ of b_{2m}^ϕ in a similar way to the ordinary blob case.

Let ρ denote the map on $\rho'(D_{2m-2}^\phi)$ that removes this cup and cap and normalisation (inverse to ρ').

Proposition 8.1.1 *The map ρ extends to an algebra isomorphism*

$$e' b_{2m}^\phi(\delta, \delta_L, \delta_R, \kappa_L, \kappa_R, \kappa_{LR}) e' \xrightarrow{\rho} b_{2m-2}^\phi(\delta, \kappa_L, \delta_R, \delta_L, \kappa_R, \kappa_{LR}). \quad (33)$$

Proof: This follows from Propositions 6.5.4 and 7.2.4. However it is useful to sketch a direct proof analogous to Proposition 5.0.4.

In order to readily distinguish δ_L and κ_L in the periodic realisation it is again useful to two-colour the diagrams. As before we set the interior of the region whose closure includes the northern interval astride the 0-reflection line to *white*. Then δ_L loops of $b_{2m}^\phi(\delta, \delta_L, \delta_R, \kappa_L, \kappa_R, \kappa_{LR})$ are white loops astride this line. The colour of the corresponding interval (and hence loops) astride the 1-reflection line depends on whether m is odd or even. (Thus the image of $f.f = \delta_R f$ is a black loop if m is odd.)

As in the ordinary blob case, comparing $\rho(a)\rho(b)$ to $\rho(ab)$ the underlying diagrams agree, and there is a correspondence between the loops produced on each side, but the cup and cap removal means that they all change colour. Thus, on applying ρ to a pseudodiagram (a diagram with loops which reduce to scalars), the roles of δ_L and κ_L are interchanged. As for δ_R and κ_R , there is a colour change due to ρ , which nominally interchanges them, but ρ also changes m between odd and even, changing back. Altogether, we have $\rho(a)\rho(b) = \rho(ab)$ with ρ as in (33). \square

We could bring the two sides of (33) closer together by making further constrained parameter choices. However, here we will concentrate on the generic case, i.e. *working with field $k = \mathbb{C}$, so that parameter space can be endowed with the Zariski topology*, we assume that Zariski open subsets of points in parameter space all have basically the same representation theory (in the sense that the basis for simple module M_λ (say) is in each case the image of the *same* module basis over ground ring K under $M_\lambda^K \mapsto k \otimes_K M_\lambda^K$ by specialisation). We will verify this assumption shortly. Under this assumption we may consider a single meta-category $b_{2m}^\phi\text{-mod}$ of left modules for b_{2m}^ϕ . Then by (8)

Proposition 8.1.2 *Map (33) provides a full embedding G of $b_{2m-2}^\phi\text{-mod}$ in $b_{2m}^\phi\text{-mod}$.*
 \square

This means in particular that we can construct prestandard modules by a recursive procedure. (NB, much representation theory can still be done with the restrictions on the field imposed here removed, but at considerable cost in brevity.)

Theorem 8.1.3 *An index set for equivalence classes of simple b_{2m}^ϕ -modules for generic parameters is $\{0\}$ for $m = 0$; and $\Lambda_m^\phi = \{-m, -m + 1, \dots, 0, \dots, m - 1\}$ for $m > 0$.*

Proof: By Proposition 2.0.1 there is for each simple module (irreducible representation) $S_\lambda(2m - 2)$ in $b_{2m-2}^\phi\text{-mod}$ a simple module in $b_{2m}^\phi\text{-mod}$ which is the head of prestandard module $G(S_\lambda)$ (using the G corresponding to (33)).

The simple modules not constructed in this way are those S obeying $eS = 0$. Since $U_1 e U_1 \sim U_1$ the element U_1 acts as zero in such representations, and hence so do all the U_i s. Thus only 1 and (possibly) f are (represented by) non-zero. Since f is (pre) idempotent there are precisely two such simple modules in general, both one-dimensional, one where f is zero (which module we will give the label $\lambda = -m$) and the other not (which module we will give the label $\lambda = m - 1$). (NB the ‘bootstrap’ case at $m = 1$ is the exception, since there, uniquely, $f e f \sim f$ and $f \cong 0$ is also forced.) \square

8.2 Combinatorics of the basis B_{2m}^ϕ

Note that if a diagram in B_{2m}^ϕ has any propagating lines then it has at least two (by the symmetry), and that there is a unique mirror image pair that can be deformed to touch the 0-reflection line at some point — the pair ‘closest’ to the 0-reflection line. There is thus a unique region of the diagram that touches both elements of this pair *and* contains a segment of the 0-reflection line. This region can be black or white. We will call it the *inner* region (and call the pair of lines the inner lines).

One way of organising diagrams into subsets is by the number of propagating lines. Within this, we may subdivide the set of those with $2l > 0$ propagating lines into those in which the inner region is black or white. Let us denote these subsets $B_{2m}^\phi[\pm l]$ respectively (note that this works at $l = +0 = -0$ since there is no inner region there).

For example:

$$B_{2m}^\phi[-m] = \{1\}; \quad B_{2m}^\phi[-(m-1)] = \{f\}; \quad B_{2m}^\phi[m-1] = \{e\}. \quad (34)$$

Remark: It is necessary to have such a labelling scheme for these subsets, and this scheme will serve our purposes. However, it is not canonical.

Following [41] let us write $\#(d)$ for the number of propagating lines in diagram d . Similarly we extend this to apply to any scalar multiple of d , so that $\#(dd')$ is defined for any two diagrams d, d' . We write $c_i(d) \in \{b, w\}$ for the inner region colour of d (and again similarly for dd').

Lemma 8.2.1 *For all d, d'*

- (1) *We have $\#(dd') \leq \#(d)$.*
- (2) *If $\#(dd') = \#(d)$ then $c_i(dd') = c_i(d)$.*

Proof: (1) is straightforward. (2) Suppose that a certain pair of lines are inner in d . These lines are still identifiable beginning at the northern edge of dd' (which is inherited from d). If they remain inner in the extension of d by d' then obviously the colour is unchanged. On the other hand if they are not inner in dd' then they are no longer propagating and $\#(dd') < \#(d)$. \square

For $l \geq 0$ define

$$BB_{2m}^\phi(l) = \bigcup_{0 \leq j \leq l} (B_{2m}^\phi[j] \cup B_{2m}^\phi[-j])$$

and $B_{2m}^\phi(0) = B_{2m}^\phi[0]$ and for $l \geq 1$

$$B_{2m}^\phi(\pm l) = B_{2m}^\phi[\pm l] \cup BB_{2m}^\phi(l-1).$$

Proposition 8.2.2 *For $l \in \{-m, -m+1, \dots, m-1\}$ the set $B_{2m}^\phi(l)$ is a basis for an ideal of b_{2m}^ϕ , and the subset structure*

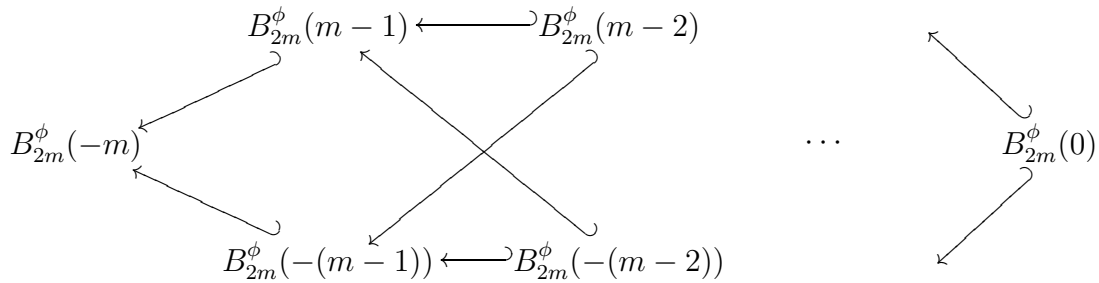

passes to a subideal structure (over any ring).

Proof: This follows directly from Lemma 8.2.1. \square

Let us name the subideals $I_{2m}^\phi(l) = kB_{2m}^\phi(l)$. Noting this structure, associate a partial order \triangleleft to Λ_m^ϕ by $l \triangleleft l'$ if and only if $|l| < |l'|$ (NB, this order is not total). We then define $I_{2m}^\phi[l]$ as the l -th section of this ideal structure, that is

$$I_{2m}^\phi[l] = \begin{cases} kB_{2m}^\phi(l)/kB_{2m}^\phi(-l-1) & l < 0 \\ kB_{2m}^\phi(l) & l = 0 \\ kB_{2m}^\phi(l)/kB_{2m}^\phi(l-1) & l > 0. \end{cases}$$

Note that $I_{2m}^\phi[l]$ has basis $B_{2m}^\phi[l]$ (where the action is the algebra multiplication, but taking account of the quotient).

Next we want to decompose these sections as left-modules, and equip their component modules with an inner product.

Half-diagrams:

Note that it is always possible to cut a diagram $d \in B_{2m}^\phi$ from the eastern to the western edge in such a way that only propagating lines are cut (and these exactly once each). Note, however, that this process is not always unique (even up to isotopy), since some diagrams with no propagating lines contain a noncontractible loop, which could lie above or below the cut. However, considering the set of *half-diagrams* produced in this way ignoring any noncontractible line, any top-bottom pair of half-diagrams with the same number of propagating lines, and inner region colour if defined, can always be recombined to produce a full CC diagram, and in exactly one way, with the caveat that the CC requirement will determine if a noncontractible loop must be inserted. We will call any such loop a *belt*.

Let us denote by $|B_{2m}^\phi[l]\rangle$ the set of upper half diagrams associated to $B_{2m}^\phi[l]$ (any l), and by $|d\rangle$ (the “ket”) the upper half diagram obtained from diagram d (write $\langle d|$ (the “bra”) for the corresponding lower half diagram). There is an obvious isomorphism of the set $|B_{2m}^\phi[l]\rangle$ with the set of bottom halves $\langle B_{2m}^\phi[l]|$, obtained by reflecting in an east-west line, that is, $|a\rangle \xrightarrow{\sim} \langle a^\circ|$. It follows that

$$B_{2m}^\phi[l] \cong |B_{2m}^\phi[l]\rangle \times \langle B_{2m}^\phi[l]| \quad (35)$$

$$d \mapsto (|d\rangle, \langle d|) \quad (36)$$

where the map is the cut map. (Note that elements of $|B_{2m}^\phi[+l]\rangle$ and $\langle B_{2m}^\phi[-l]|$ can be concatenated with $l > 0$, but they will not produce a CC diagram.) We may write the inverse map as a multiplication:

$$(|d\rangle, \langle d|) \mapsto |d\rangle\langle d|.$$

For $|a\rangle \in |B_{2m}^\phi[0]\rangle$ write Belt_a for the subset of elements $\langle b| \in \langle B_{2m}^\phi[0]|$ such that $|a\rangle\langle b|$ has a belt. The partition of $\langle B_{2m}^\phi[0]|$ into two parts defined by Belt_a (as one of the parts) is independent of a , and written simply as Belt . Note that

Lemma 8.2.3 *If $d, d' \in B_{2m}^\phi[l]$ and $\#(dd') = |l|$ then*
(i) there is a monomial in the parameters $k_{dd'}$ such that

$$dd' = k_{dd'}|d\rangle\langle d'|. \quad (37)$$

(ii) This $k_{dd'}$ depends on $\langle d|$ and $|d'\rangle$ but does not depend on $\langle d'|$ and $|d\rangle$, except in case $l = 0$ through the noncontractible loop caveat.

(iii) No top-bottom symmetric diagram $|a\rangle\langle a^o|$ has a belt. If $l = 0$ and $dd' = |a\rangle\langle b||c\rangle\langle a^o|$ write $\langle b||c\rangle_a$ for $k_{dd'}$. Let M_a be the matrix $(\langle b||c\rangle_a)_{b,c}$. Let M'_a be the matrix obtained from M_a by dividing every row with $b \in \text{Belt}_a$ by κ_{LR} ; and let M''_a be the matrix obtained from M_a by dividing every column with $c \in \text{Belt}_a$ by κ_{LR} . If a, a' are in the same part of Belt, then $M_a = M_{a'}$. If a, a' are in different parts of Belt, then $M'_a = M''_{a'}$.

(iv) Now let $d' \in B_{2m}^\phi[l]$ and $d'' \in B_{2m}^\phi[l']$ be such that $\#(d''d') = |l|$ (d'' could have more than $|l|$ propagating lines). Then

$$d''d' = \sum_{d \in |B_{2m}^\phi[l]|} k'_d |d\rangle\langle d'|,$$

where the k'_d depend on d'' and $\langle d'|$, but not on $|d'\rangle$.

Proof: (i) The product dd' is some scalar times a diagram. Under the given conditions it is clear that this diagram must have the given ket-bra form.

(ii) This follows from the definition of the cut map.

(iii) The first part is obvious. If a, a' are in the same part of Belt, then the calculations for each $\langle b||c\rangle_a$ and $\langle b||c\rangle_{a'}$ are identical. Otherwise there are four types of case in comparing $\langle b||c\rangle_a$ and $\langle b||c\rangle_{a'}$:

- 1) if $\{b, c\} \cap \text{Belt}_a = \{b, c\}$ then the matrix elements differ precisely by a factor κ_{LR} on the a side, which is adjusted by the division on the a side;
- 2) if $\{b, c\} \cap \text{Belt}_a = \{b\}$ then both sides have at least one factor κ_{LR} , and are the same, and both have this factor divided out;
- 3) if $\{b, c\} \cap \text{Belt}_a = \{c\}$ similarly;
- 4) if $\{b, c\} \cap \text{Belt}_a = \emptyset$ then the matrix elements differ precisely by a factor κ_{LR} on the a' side, which is adjusted by the division on the a' side.

(iv) As for (i). (NB, there can only be one term in the sum, because the diagram basis is a monomial basis, i.e. the product of any two diagrams is a scalar multiple of another.) \square

Indeed, since

$$dd' = |d\rangle\langle d| |d'\rangle\langle d'| = k_{dd'} |d\rangle\langle d'| \quad (38)$$

we will sometimes write $\langle d||d'\rangle$ for $k_{dd'}$ when no ambiguity arises.

Proposition 8.2.4 *Let $d, d' \in B_{2m}^\phi[l]$.*

(i) *There exist diagrams a, b , and a nonzero monomial in the parameters k , such that $adb = kd'$. That is, provided all the parameters are units then every diagram in $B_{2m}^\phi[l]$ generates $B_{2m}^\phi(l)$.*

(ii) *For a any diagram, if $\#(dad') = l$ then $dad' = k_a |d\rangle\langle d'|$ where k_a is a nonzero monomial in the parameters.*

Proof: (i) Note that if d^o is the ‘opposite’ diagram of d (the same diagram drawn upside-down) then $\#(d^o d) = \#(dd^o) = l$. Consider $a = |d'\rangle\langle d^o|$ and $b = |d^o\rangle\langle d'|$, then

$$adb = |d'\rangle\langle d^o||d\rangle\langle d||d^o\rangle\langle d'| = k |d'\rangle\langle d'| = kd'$$

For the second part of (i) it is now enough to show that we can get from some diagram in $B_{2m}^\phi[l]$ to (some appropriate scalar multiple of) some diagram in $B_{2m}^\phi[\pm(l-1)]$. This is routine for a suitable choice of diagram in each case. For example, for $2j \leq m-2$ then $w = eU_2U_4 \dots U_{2j}f \in B_{2m}^\phi[m-2j-2]$; while for $2j < m-2$ then $U_{m-1}wU_{m-1} = \kappa_R w'$ with $w' = eU_2U_4 \dots U_{2j}U_{m-1} \in B_{2m}^\phi[m-2j-3]$.
(ii) Similarly we have:

$$dad' = |d\rangle\langle d||a\rangle\langle a||d'\rangle\langle d'| = (\langle d||a\rangle \langle a||d'\rangle) |d\rangle\langle d'|$$

and $\langle d||a\rangle$ and $\langle a||d'\rangle$ are nonzero by construction. \square

An immediate corollary to 8.2.4(i) is

Corollary 8.2.5 *Subject to the same parameter restriction as in 8.2.4(i), no unit multiple of any diagram is in the radical.* \square

For $i = 0, 1, 2, \dots, m-1$ define $S_i = I_{2m}(-i)$ and $T_i = I_{2m}(i) + I_{2m}(-i)$. Note by Proposition 8.2.2 that the following is a chain of ideals in b_{2m}^ϕ

$$S_0 \subseteq S_1 \subseteq T_1 \subseteq S_2 \subseteq T_2 \subseteq \dots \subseteq T_{m-1} \subseteq S_m = I_{2m}(-m) = b_{2m}^\phi. \quad (39)$$

For each $l \in \Lambda_m^\phi$ and $d \in B_{2m}^\phi[l]$ define b_{2m}^ϕ modules by $\mathcal{S}_{2m}^d(0) := b_{2m}^\phi d$ if $l = 0$ and otherwise

$$\mathcal{S}_{2m}^d(l) := \frac{b_{2m}^\phi d + S}{S} \quad (40)$$

where $S = T|_{|l|-1}$.

Note that right multiplication by d' gives a map $\gamma_{d'} : \mathcal{S}_{2m}^d(l) \mapsto \mathcal{S}_{2m}^{d'}(l)$. Thus by Proposition 8.2.4(i):

Lemma 8.2.6 *If $\delta, \delta_L, \delta_R, \kappa_L, \kappa_R, \kappa_{LR}$ are units then the precise choice of d is irrelevant, up to isomorphism, in $\mathcal{S}_{2m}^d(l)$. In this case define $\mathcal{S}_{2m}(l) = \mathcal{S}_{2m}^d(l)$.*

Note that $d \in B_{2m}^\phi[l]$ can always be chosen to have no non-contractible lines. In this case the module $\mathcal{S}_{2m}(l)$ has basis $b_{2m}^\phi d \cap B_{2m}^\phi[l]$, where the action is the algebra multiplication, but taking account of the quotient. Further $b_{2m}^\phi d \cap B_{2m}^\phi[l] \cong |B_{2m}^\phi[l]\rangle$.

We may extend the notation $\langle d||d'\rangle$ to a map $(\langle B_{2m}^\phi[l]|, |B_{2m}^\phi[l]\rangle) \rightarrow K$ by $\langle d||d'\rangle = 0$ if $\#(dd') < l$. Via the involution $|\rangle \xrightarrow{\sim} \langle|$ the map $\langle -||-\rangle$ extends (bi)linearly to an inner product on $\mathcal{S}_{2m}^d(l)$.

Define

$$\Gamma_{2m}^{d''}(l) = \det((\langle d||d'\rangle)_{n \times n}) \quad (41)$$

where $d^\circ, d' \in b_{2m}^\phi d'' \cap B_{2m}^\phi[l]$, for a fixed $d'' \in B_{2m}^\phi$ (the basis of $\mathcal{S}_{2m}(l)$) and $n = \dim \mathcal{S}_{2m}(l)$. Note from Lemma 8.2.3 that $\Gamma_{2m}^{d''}(l)$ does not depend on d'' if $l \neq 0$; and depends on d'' only through at most an overall factor of a power of κ_{LR} if $l = 0$. Choosing the lowest power in this overall factor, we will write simply $\Gamma_{2m}(l)$ in all cases.

We will address the specific computation of the Gram determinant later, but note that the matrix entries are monomial in the parameters. We have

Proposition 8.2.7 *For each $l \in \Lambda_m^\phi$ there is a polynomial P in the parameters such that the prestandard module of b_{2m}^ϕ associated to l has Gram determinant given by evaluation of P at the appropriate specialisation. Every prestandard is generically simple.*

Proof: By computing $\Gamma_{2m}(l)$ with the parameters treated as indeterminates we obtain the polynomial P . By Proposition 2.1.1 the inner product we have defined is unique up to scalars, and the Gram determinant is nonvanishing in any given parameter choice if and only if the module is simple there. ‘Generically’ has the meaning of Zariski open here, so it is only necessary to show that no such polynomial P is identically the zero polynomial. This can be done by considering asymptotic cases of the parameters. (The power of δ , say, is maximal on the diagonal for all rows of the matrix, and uniquely maximal there for some rows, so the determinant is not zero.) \square

Theorem 8.2.8 *Let $*$ be the K -linear involutory antiautomorphism on b_{2m}^ϕ defined by flipping each diagram upside-down, i.e. by reflection in a horizontal line. For each $l \in \Lambda_m^\phi$ let $M(l)$ be one of the diagram bases of $\mathcal{S}_{2m}(l)$; and let C be the ket-bra combination of basis elements. Then b_{2m}^ϕ is cellular over K with cell datum $(\Lambda_m^\phi, M, C, *)$.*

Proof: Note that $*$ is an algebra antiautomorphism by top-bottom symmetry of the reduction rules. Proposition 8.2.2, Lemma 8.2.3 and (40) verify the axioms given in [19]. \square

Theorem 8.2.9 *If $\delta, \delta_L, \delta_R, \kappa_L, \kappa_R, \kappa_{LR}$ are units then b_{2m}^ϕ is quasihereditary, and the chain (39) is a heredity chain.*

Proof: It is enough to show that the chain is heredity (one might also see [32]). We need to show for $S = S_i$ or $S = T_i$ where $A = b_{2m}^\phi/T_{i-1}$ if $S = S_i$ and $A = b_{2m}^\phi/S_i$ if $S = T_i$:

- (1) that $S^2 = S$
- (2) that $SJS = 0$ for $J = \text{rad}(A)$
- (3) that each section defined by the proposed hereditary chain of ideals is projective in the quotient. I.e. that S/T_{i-1} (resp. S/S_i is projective in A).

Suppose $S = S_i$ for some i , so S_i contains all diagrams with i propagating lines and white inner region and all diagrams with fewer than i propagating lines.

Take $d \in B_{2m}[-i]$. Then $\#(dd^\circ) = i$. Thus S_i^2 contains a diagram with white inner region and i propagating lines. Proposition 8.2.4(i) then says that $S_i \subset S_i^2$ and so $S_i^2 = S_i$.

We now show that $SJS = 0$ where $J = \text{rad}b_{2m}^\phi/T_{i-1}$. Consider djd' , with $d, d' \in B_{2m}^\phi(-i)$ and $j \in J$. Now write $j = (\sum m_\alpha j_\alpha) + T_{i-1}$ where m_α are in the base ring K and $j_\alpha \in B_{2m}^\phi$. If $\#(dj_\alpha d') \leq i-1$ then $dj_\alpha d'$ is zero in the quotient b_{2m}^ϕ/T_{i-1} .

If $\#(dj_\alpha d') = i$ then Proposition 8.2.4(ii) says that $dj_\alpha d' = k_\alpha dd'$ for some k_α in the ring and so $djd' = (\sum m_\alpha k_\alpha) dd' + T_{i-1}$ (where the sum is over those j_α such that $\#dj_\alpha d' = i$).

If $\#(dd') < i$ then $djd' = 0$ in the quotient. If $\#(dd') = i$ then $(dd')^r = k^r dd' \notin T_{i-1}$ for some k a non-zero monomial in the parameters and for all r and so $dd' + T_{i-1} \notin J$. Thus for djd' to be nilpotent in the quotient we need $(\sum m_\alpha k_\alpha) dd'$ to be zero and thus $djd' = 0$. Thus $SJS = 0$.

Finally we need S_i/T_{i-1} to be projective as a b_{2m}^ϕ/T_{i-1} -module.

The section S_i/T_{i-1} splits up into a direct sum of modules $b_{2m}^\phi d/T_{i-1}$ for $d \in B_{2m}^\phi[-i]$. (Note that $b_{2m}^\phi d/T_{i-1} = b_{2m}^\phi d'/T_{i-1}$ if and only if $\langle d \rangle = \langle d' \rangle$.) The action of

the algebra on the *right* gives maps between these modules for different choices of d . These maps are invertible by Proposition 8.2.4, so the summands are isomorphic. Note that there exists at least one d in each $B_{2m}^\phi[-i]$ that is idempotent up to a unit, thus each summand is projective.

The argument for $S = T_i$ is very similar. \square

Corollary 8.2.10 *If $\delta, \delta_L, \delta_R, \kappa_L, \kappa_R, \kappa_{LR}$ are units then the modules $\mathcal{S}_{2m}(l)$ are the standard modules of b_{2m}^ϕ .*

By Proposition 8.1.1 the globalisation functor G is

$$G : b_{2m-2}^\phi(\delta, \delta_L, \delta_R, \kappa_L, \kappa_R, \kappa_{LR}) \rightarrow b_{2m}^\phi(\delta, \kappa_L, \delta_R, \delta_L, \kappa_R, \kappa_{LR})$$

We may ‘dually’ define another globalisation functor using the right hand blob (in Proposition 8.1.1) rather than the left hand one. We get a functor

$$G' : b_{2m-2}^\phi(\delta, \delta_L, \delta_R, \kappa_L, \kappa_R, \kappa_{LR}) \rightarrow b_{2m}^\phi(\delta, \delta_L, \kappa_R, \kappa_L, \delta_R, \kappa_{LR}).$$

It is clear that $G \circ G' = G' \circ G$. We thus get three functors from b_{2m-4}^ϕ to b_{2m}^ϕ (as meta-categories, i.e ignoring the swapping of parameters).

Proposition 8.2.11 *If $\delta, \delta_L, \delta_R, \kappa_L, \kappa_R, \kappa_{LR}$ are units then*

$$G(\mathcal{S}_{2m-2}(l)) \cong \mathcal{S}_{2m}(-l)$$

$$G'(\mathcal{S}_{2m-2}(l)) \cong \mathcal{S}_{2m}(l)$$

Proof: Since b_{2m}^ϕ is quasi-hereditary under the assumption on the parameters, globalising takes standard modules to standard ones [39, Proposition 4]), and we need only determine which one. Globalising does not change the number of propagating lines. The colour of the inner region changes for G but stays the same for G' , hence the change in sign for G but not for G' . \square

Note that for these algebras b_{2m}^ϕ we have shown that there is a set of prestandard modules which are in fact standard.

8.3 Prestandard modules by G_e : Low rank examples

Let us begin the recursion, implicit in the proof of Theorem 8.1.3, to construct prestandard modules using G :

We can apply G equally to simple modules directly, or to the regular representation (and hence to diagrams), since the regular representation is a direct sum of projective representations, each with an appropriate unique simple module in its head. Firstly, b_0^ϕ is spanned by the empty diagram, which is thus also a basis for the unique simple left module, $S_0(0)$. Applying G to this will give $S_2(0)$. Now by virtue of Proposition 2.3.1 the image of this under G is given by the image under ρ' , which is

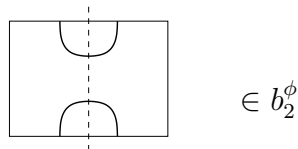

In this case the multiplication map is a bijection, and the above element generates the left prestandard module $S_2(0)$ with basis consisting of this and one other diagram:

(42)

(note that this set is spanning by the κ' relation). Observe that this basis has no intrinsic dependence on the parameters.

Consider the module morphism between ideals given by $m \mapsto mf$ here. We are considering the generic case (so that κ' is invertible) so

(43)

span the isomorphic image module to that above (we will touch on the chiral case $RLR \not\propto R$ elsewhere). Note that the elements in (42),(43) span $b_2^\phi e b_2^\phi$. By proposition 2.0.1 the simple module missing from this construction ($S_2(-1)$) may be constructed as $b_2^\phi / b_2^\phi e b_2^\phi$. Thus $S_2(-1)$ has basis

(44)

where the action of the algebra is algebra multiplication modulo the elements in (42),(43). Note that $|B_2^{\phi_0}| = 5$ so this is a complete decomposition of the regular module.

Applying G again we determine the structure of b_4^ϕ . The image of b_2^ϕ is as follows. The image of the basis elements for $S_2(0)$ in (42) is the first two elements of:

(45)

(the other two are generated from these by the algebra action); thus these objects are a basis for $S_4(0)$. Another basis for this module is obtained as the image of the elements in (43) (and two further elements generated from these):

It is left as an exercise to write down two more sets of four elements giving bases for isomorphic modules. The object in (44) is not strictly an element of the algebra (because of the quotient). Thus we cannot apply ρ' to it directly. However we can consider $S_2(-1)$ as $b_2^\phi/b_2^\phi eb_2^\phi$ and apply ρ' to b_2^ϕ . Applying ρ' to (44) and to the quotienting module spanned by (42),(43) we have a basis for $S_4(-1)$:

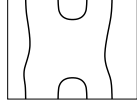

The two missing simple modules are in $b_4^\phi/b_4^\phi eb_4^\phi$. Discarding all the diagrams in $b_4^\phi eb_4^\phi$ (constructed above) these are given by

$$S_4(-2) = k \left[\begin{array}{c} \text{Diagram 1} \\ \text{Diagram 2} \\ \text{Diagram 3} \\ \text{Diagram 4} \end{array} \right]$$

and

$$S_4(+1) = k \left[\begin{array}{c} \text{Diagram 1} \\ \text{Diagram 2} \\ \text{Diagram 3} \\ \text{Diagram 4} \end{array} \right]$$

This completes the arrangement of the basis elements for the left regular representation. We have total rank $4^2 + 1 + 1 + 1$.

The ρ' -image of the basis elements for $S_4(0)$ in (45) is the first four elements of:

(46)

(the other four are generated from these by the algebra action); thus these objects are a basis for $S_6(0)$.

The general pattern can now be given.

8.4 Top-half combinatorics

Suppose that we view the right half of the fundamental region of a diagram, and concentrate for the moment on the m vertices in the northern edge in this interval — as it were, the upper right-hand *quarter* of the diagram. In basis elements with no propagating lines, the line from each of these vertices descends (initially) and turns either to Left or to Right. Considering each such line in turn, starting from the left, say, we may construct (the upper half of) a diagram by choosing the direction of these lines. Each direction may be chosen freely, in turn, irrespective of the direction

of previously chosen lines: we can always choose Right since the direction of lines *to the right* have yet to be chosen; we can always choose Left since either there is a path to the left edge (the existing choices make Right-Left pairs, i.e. cups, possibly nested, possibly together with some additional Left directed lines); or there is a preceding Right not in a Right-Left pair, which can then form a Right-Left pair with this new Left. Some examples of these quarter diagrams are as follows (the shorthand on the left in each example is L for line-turn-left; R for line-turn-right):

$$\text{LLRL} = \overline{\cup\cup} \quad \text{RRLL} = \overline{\cup\cup} \quad (47)$$

In consequence the rank of the prestandard module $S_{2m}(0)$ is

$$||B_{2m}^\phi[0]\rangle\rangle = 2^m$$

This is because the composites of these elements with any element of $\langle B_{2m}^\phi[0] \rangle$ produces a basis for $S_{2m}(0)$.

Altogether the tower of bases starts as shown in figure 3, where o denotes a propagating line. The key for the shorthand used in this table is indicated in (47) above, and by

$$\text{LLL} = \overline{\cup\cup\cup} \quad \text{LRL}o = \overline{\cup\cup\cup} \quad (48)$$

Let us write $\text{ur}_1(d)$ for the number of lines passing out of the fundamental region of a (half-)diagram through the 1-wall on the right, not counting those lines which also pass out on the left ('equatorial' lines, as it were). Thus for example the 4-th diagram in (46) has $\text{ur}_1(d) = 2$. (We will also later use $\text{ur}_0(d)$ for the number of lines crossing the 0-wall of a (half-)diagram: the left hand edge, then, of a quarter diagram.)

Note that the set of half-diagrams with given m and $l = +x$ ($x > 0$) is that set with x propagating lines and $\text{ur}_1(d) \equiv 1 \pmod{2}$, while the set of half-diagrams with given m and $l = -x$ ($x > 0$) is that set with x propagating lines and $\text{ur}_1(d) \equiv 0 \pmod{2}$.

8.5 Restriction of prestandards to blob algebra standards

The representation of b_3 induced on the basis for $S_6(0)$ in (46) is as follows (we use the isomorphism with b'_6 — and by virtue of proposition 4.3.3 we use b_m and b'_{2m} interchangeably in this section):

$$R_0(\langle \left\{ \left\{ \bigcup \right\} \right\} \rangle) = \begin{pmatrix} \delta_L & & & & & \\ & \delta_L & & & & \\ & & \delta_L & & & \\ & & & \delta_L & & \\ 1 & & & & 0 & \\ & 1 & & & & 0 \\ & & \kappa & & 0 & \\ & & & \kappa & & 0 \end{pmatrix}$$

$m =$	$l = 3$	2	1	0	-1	-2	-3	-4
0				$\{\emptyset\}$				
1				$\begin{Bmatrix} L \\ R \end{Bmatrix}$	$\{o\}$			
2			$\{oR\}$	$\begin{Bmatrix} LL \\ LR \\ RL \\ RR \end{Bmatrix}$	$\{Lo\}$	$\{oo\}$		
3		$\{ooR\}$	$\{LoR\}$	$\begin{Bmatrix} LLL \\ LLR \\ LRL \\ LRR \\ RLL \\ RLR \\ RRL \\ RRR \end{Bmatrix}$	$\begin{Bmatrix} LLo \\ RLo \\ oRL \\ oRR \end{Bmatrix}$	$\{Loo\}$	$\{ooo\}$	
4	$\{oooR\}$	$\{LooR\}$	$\begin{Bmatrix} oRRR \\ oRLR \\ oRRL \\ RLoR \\ LLoR \end{Bmatrix}$	$\begin{Bmatrix} LLLL \\ LLLR \\ LLRL \\ LLRR \\ LRLL \\ \dots \\ RRRR \end{Bmatrix}$	$\begin{Bmatrix} LLLo \\ LRLo \\ RLLo \\ LoRL \\ LoRR \end{Bmatrix}$	$\begin{Bmatrix} LLoo \\ RLoo \\ oRLo \\ ooRL \\ ooRR \end{Bmatrix}$	$\{Looo\}$	$\{oooo\}$

Figure 3: Table of standard $S_{2m}(l)$ bases up to $m = 4$. NB, this LR shorthand should NOT be confused with the nonabelian ring elements which live on strings — see main text for key.

$$R_0\left(\begin{matrix} \cup & \cup \\ \cap & \cap \end{matrix}\right) = \begin{pmatrix} 0 & & \kappa_L & & & & \\ & 0 & & \kappa_L & & & \\ & & 0 & 1 & & & \\ & & & 0 & 1 & & \\ & & & & \delta & & \\ & & & & & \delta & \\ & & & & & & \kappa_R & 0 \\ & & & & & & 1 & 0 \end{pmatrix}$$

$$R_0\left(\begin{matrix} \cup & \cup \\ \cap & \cap \end{matrix}\right) = \begin{pmatrix} 0 & \delta_L & & & & & & \\ & 0 & \kappa & & & & & \\ & & \delta & & & & & \\ & & \delta_R & 0 & & & & \\ & & 1 & & 0 & & & \\ & & & & & 0 & 1 & \\ & & & & & & 0 & \delta_R \\ & & & & & & & \delta \end{pmatrix}$$

(all unmarked entries zero). Note that basis elements in positions 1,3,5 span a b_3 -submodule isomorphic to $\Delta_3^b(1)$ (where $\Delta_m^b(l) = \Delta_m(l)$ of [42]). The quotient by this has b_3 -submodule spanned by elements 2,6,8, isomorphic to $\Delta_3^b(-1)$. The quotient by this has b_3 -submodule spanned by element 4, isomorphic to $\Delta_3^b(-3)$. The remaining quotient is isomorphic to $\Delta_3^b(3)$.

We can see this decomposition directly by looking at (46). Note for general $S_{2m}(l)$ that the number $ur_1(d)$ cannot be increased by acting on a half-diagram by an element of b_m (i.e. of b'_{2m}). Thus

Proposition 8.5.1 *The restriction $Res_{b'_{2m}}^{b_\phi} S_{2m}(l)$ has submodule structure filtered by ur_1 . In particular $Res_{b'_{2m}}^{b_\phi} S_{2m}(0)$ has $m+1$ sections, since all the ur_1 values are realised from 0 to m . Meanwhile $Res_{b'_{2m}}^{b_\phi} S_{2m}(l)$ with $l = \pm x$ ($x > 0$) has ur_1 values from, and hence sections indexed by:*

- $\{m-x-1, m-x-3, \dots, 0\}$ if $m-x$ odd and $l < 0$;
- $\{m-x, m-x-2, \dots, 1\}$ if $m-x$ odd and $l > 0$;
- $\{m-x-1, m-x-3, \dots, 1\}$ if $m-x$ even and $l > 0$;
- $\{m-x, m-x-2, \dots, 0\}$ if $m-x$ even and $l < 0$.

Proof: Only the $l \neq 0$ cases require further explanation. Here, since there are propagating lines, there can be no equatorial line (passing from one reflection wall to the other), so the lines contributing to ur_1 all start from the northern edge of the diagram. Consider the lines passing out of the m vertices on the northern edge of the diagram. The number of propagating lines is fixed at x , and the total number $ur_1 + ur_0$ of lines passing to the reflection walls is of definite parity, since all other lines return to the north edge and hence contribute to m in pairs. But the parity of ur_0 is fixed by the sign of l , so the parity of ur_1 is also fixed. It is routine to check the extremal numbers. \square

Consider the r -th ur_1 -section of $Res_{b'_{2m}}^{b_\phi} S_{2m}(l)$ ($l = \pm x$ ($x > 0$)). As already noted, ur_0 is of definite parity in this section. If ur_0 is even, there is an injective map from

the basis elements in this section into the basis elements of a b'_{2m} standard module $\Delta^b((x+r))$, obtained by deforming the ends of the r lines that pass out through the 1-wall until they pass out through the bottom of the diagram (i.e. become propagating lines). It is easy to see that this extends to a module morphism. Since the section is a blob module the map must be onto and hence a bijection. There is a similar morphism for ur_0 odd.

Proposition 8.5.2 *In the ur_1 -sections of $Res_{b'_{2m}}^{b_\phi} S_{2m}(l)$ ($l = \pm x$ ($x > 0$)) an ur_1 -line acts like a propagating line. If $m-x$ odd and $l < 0$, or $m-x$ even and $l > 0$, then the inner region is black so the first ur_0 line also acts as a propagating (and blobbed) line. Taking into account the x lines that are already propagating, the section with $ur_1 = r$ is thus isomorphic to a b'_{2m} standard module of form $\Delta^b(-(x+r+1))$ if one of the ‘black’ conditions above is satisfied; and of form $\Delta^b(x+r)$ otherwise. (NB, the sign on the weight here does not affect the dimension of the module.) A similar statement holds for $l = 0$, so that $Res_{b'_{2m}}^{b_\phi} S_{2m}(0)$ is a sum of one copy of each blob standard. \square*

Recall that the dimension of $S_{2m}(0)$ is 2^m .

Corollary 8.5.3 *Consider the prestandard $S_{2m}(l)$, where $l = \pm x$ and $x > 0$. Define the integer ϵ by*

$$\begin{aligned} \epsilon &= 1 \text{ if } m - x \text{ odd,} \\ \epsilon &= 2 \text{ if } m - x \text{ even and } l > 0, \\ \epsilon &= 0 \text{ if } m - x \text{ even and } l < 0, \end{aligned}$$

and let $k = (m - (x + \epsilon))/2$. Then the dimension of $S_l(2m)$ is given by $\sum_{i=0}^k \binom{m}{i}$.

Proof: From [41], the dimension of the b'_{2m} -standard module $\Delta^b(\pm c)$ is given by $\binom{m}{(m-c)/2}$. The result now follows from Proposition 8.5.2, summing over the r -values specified in Proposition 8.5.1. \square

Thus we have determined the complete generic representation theory.

Note that the globalisation and localisation functors act in a natural way on blob categories as well as symplectic blob categories. We did not need this fact here, but it is useful in computing non-generic representation theory.

9 Discussion

Having determined the generic representation theory, and set up the homological machinery for analysing the exceptional (non-semisimple) cases, in our next paper we will turn to computing the representation theory of the exceptional cases. We conclude here with a brief introduction to this problem.

With the Temperley–Lieb and blob algebras, the symplectic blob algebra (or isomorphically, b_{2m}^ϕ) belongs to an intriguing class of Hecke algebra quotients. The first two have representation theories beautifully and efficiently described in alcove geometrical language, where the precise geometry is determined, in the non-semisimple cases, by the parameters of the algebra. In these first two algebras the parameterisation appropriate to reveal this structure is not that in which the algebras were first described. Rather, it was discovered during efforts to put the low rank data on

non-semisimple manifolds in parameter space in a coherent format [41]. The determination of the representation theory of b_{2m}^ϕ in the non-semisimple cases is the next important problem in the programme initiated in this paper. We therefore conclude the paper with one result on the characterisation of non-semisimple manifolds. The crucial point is that because of the globalisation map, this is derived from a low rank result, which then globalises to all levels in the tower.

Throughout this section we will assume that all the parameters are units, so b_{2m}^ϕ is quasihereditary.

Set $L_{2m}(l)$ to be the irreducible head of the standard module $\mathcal{S}_{2m}(l)$. At any point in parameter space for which the Gram determinant $\Gamma_{2m}(l)$ evaluates to zero, there is a proper submodule of $\mathcal{S}_{2m}(l)$ and so $\mathcal{S}_{2m}(l)$ is not simple. In this case using the fact that b_{2m}^ϕ is quasihereditary we can find a non-zero map $\mathcal{S}_{2m}(j) \rightarrow \mathcal{S}_{2m}(l)$ for some $j \neq l$. Once we have found a non-zero map we can then globalise it to larger m , using functor G and Proposition 8.2.11.

Define polynomials in the six parameters $\{\delta, \delta_L, \delta_R, \kappa_L, \kappa_R, \kappa_{LR}\}$:

$$\begin{aligned} K_0 &= \kappa_{LR} \\ K_1 &= \delta_L \delta_R - \kappa_{LR} \\ K_2 &= \kappa_{LR} - \delta_L \kappa_R - \kappa_L \delta_R + \delta \delta_L \delta_R \\ K_3 &= \delta^2 \delta_L \delta_R - \delta \delta_L \kappa_R - \delta \delta_R \kappa_L - \delta_l \delta_R + \kappa_L \kappa_R \\ K_{1,3} &= \delta^2 \delta_L \delta_R - \delta \delta_L \kappa_R - \delta \delta_R \kappa_L + \kappa_L \kappa_R - \kappa_{LR} \end{aligned}$$

and commuting operators Φ and Ψ on the space of six-parameter polynomials which swap the second and fourth, respectively third and fifth, parameters. The non-trivial Gram determinants for b_6^ϕ are:

$$\Gamma_6(-1) = \kappa_L \kappa_R K_3$$

$$\Gamma_6(0) = \kappa_{LR}^4 K_1^4 \Psi \Phi(K_1) \Psi(K_2) \Phi(K_2) K_{1,3}$$

We may deduce maps: $S_6(-1) \hookrightarrow S_6(0)$ for $K_1 = 0$, $S_6(1) \hookrightarrow S_6(0)$ for $\Psi \Phi(K_1) = 0$, $S_6(2) \hookrightarrow S_6(0)$ for $\Phi(K_2) = 0$ and $S_6(-2) \hookrightarrow S_6(0)$ for $\Psi(K_2) = 0$. We may deduce that the only possible non-zero map to $S_6(-1)$ is $S_6(-3) \hookrightarrow S_6(-1)$ and this therefore must occur when $K_3 = 0$.

We also get a non-zero map $S_6(-3) \hookrightarrow S_6(0)$ when $K_{1,3} = 0$. Thus when both $K_1 = 0$ and $K_3 = 0$ we get two copies of $S_6(-3)$ in the socle of $S_6(0)$.

Proposition 9.0.4 $b_{2m}^\phi(\delta, \delta_L, \delta_R, \kappa_L, \kappa_R, \kappa_{LR})$ is not semisimple when

- (1) $K_3 = 0$ and m is odd and $m \geq 3$
 - $\Phi(K_3) = 0$ and m is even and $m \geq 4$
 - $\Psi(K_3) = 0$ and m is even and $m \geq 4$
 - $\Phi \Psi(K_3) = 0$ and m is odd and $m \geq 5$.
- (2) $K_{1,3} = 0$ and m is odd and $m \geq 3$
 - $\Phi(K_{1,3}) = 0$ and m is even and $m \geq 4$
 - $\Psi(K_{1,3}) = 0$ and m is even and $m \geq 4$
 - $\Psi \Phi(K_{1,3}) = 0$ and m is odd and $m \geq 5$.

Cases (1) are proved by globalising the map $S_6(-3) \rightarrow S_6(-1)$ for $b_6^\phi(\delta, \delta_L, \delta_R, \kappa_L, \kappa_R, \kappa_{LR})$ with $K_3 = 0$; cases (2) are proved by globalising the map $S_6(-3) \rightarrow S_6(0)$ for $b_6^\phi(\delta, \delta_L, \delta_R, \kappa_L, \kappa_R, \kappa_{LR})$ with $K_{1,3} = 0$.

Appendix

A Proof of Proposition 3.3.7

To prove: that the set $D_{n,m}^{z,l}$, can be generated by the set

$$B := \{\mathbb{I}\} \cup \{L_i\}_{i=1}^{l+1} \cup \{U_i\}_{i=1}^{n-1}.$$

Clearly the set of diagrams generated by B is contained in $D_{n,m}^{z,l}$, since concatenation can never increase the level of coveredness of a particular string. So we need only prove that $D_{n,m}^{z,l}$ is contained in the set of diagrams generated by B . We sketch a proof of this by induction on l .

If $l = -1$ and there are no decorated lines, then this is just the result for the diagram version of the Temperley–Lieb algebra [35].

Now suppose $l = 0$ and we have a diagram with a decorated 0-covered line with j beads. Since the decorated line is 0-covered there are two possibilities. Either the line is the string starting at the first position or ending at the first position - in which case we can decompose in the diagram into a product of j L_0 's together with a smaller diagram with one less 0-decorated line, or vice versa, or the line is starting at a greater position than the first. In this case we get a diagram that looks like figure 4 where we have only decorated the 0-covered line with one bead rather than j beads for simplicity. We have drawn a propagating 0-covered line; the dashed line represents a non-propagating 0-covered line. Now note that the grey

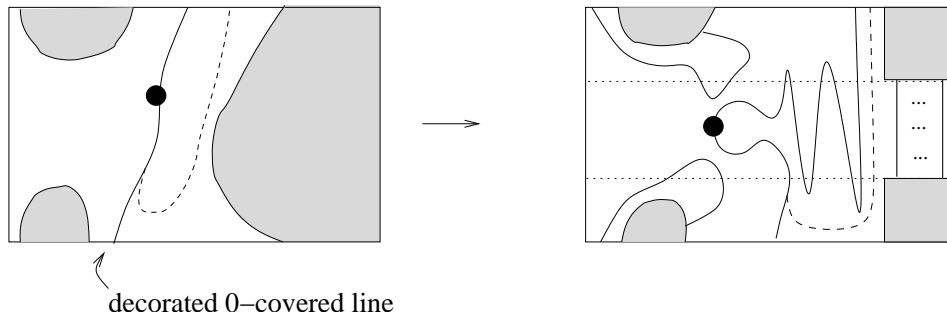

Figure 4:

regions to the left of the decorated line cannot contain any propagating lines - since the decorated line is 0-covered. But both these regions must contain at least one string that is 0-covered and so we can deform the diagram to look like that on the right hand side of figure 4.

We can arrange it so the two grey regions on the right hand side are only joined by propagating lines and the number of these lines x , say will be the same (respectively different) parity as n if the decorated 0-covered line is non-propagating (respectively propagating). Thus the difference $n - x$ is even if the 0-covered line is non-propagating and odd if the 0-covered line is propagating. We now “wiggle” the 0-covered line enough times so that we get the right number of lines so that the middle section of the diagram enclosed in dotted lines is now the diagram product $U_1 L_1 U_2 U_1$ (which has $n - 3$ propagating lines).

So we can decompose the diagram into a product of three smaller diagrams, the outside diagrams having a smaller number of 0-covered lines.

The case with $l \geq 1$ is similar and is illustrated in figure 5 below. We have drawn a propagating l -covered line; the dashed line represents a non-propagating l -covered line. We can assume that the $l - 1$ -covered line (which may be decorated or not) is propagating, for otherwise the l -covered line would not be l -covered.

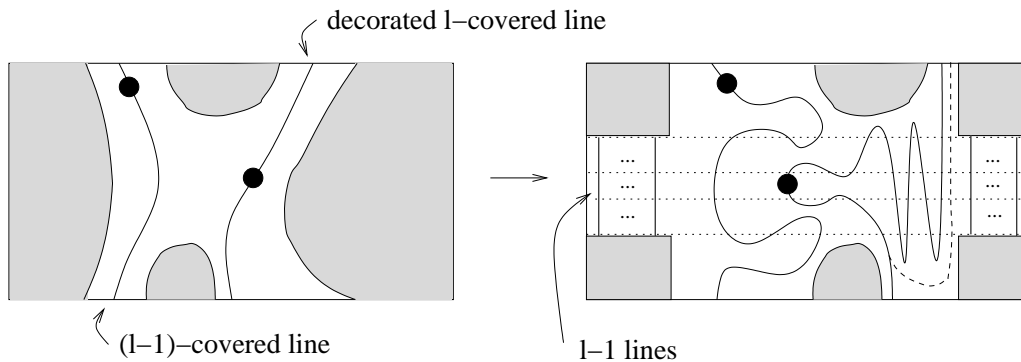

Figure 5:

Note that now when we “pull apart” the grey regions we can always stretch them so that we can get only propagating lines joining the two smaller grey regions. Also note that the number of propagating lines in the grey region on the left hand side is at exactly $l - 1$, for otherwise the $l - 1$ -covered line would not be $l - 1$ -covered. We again get the right parity, so that we can “wiggle” the l -covered line so that the middle section of the diagram enclosed in dotted lines is now the diagram product $U_{l+1} L_{l+1} U_{l+2} U_{l+1}$, and so we can decompose the diagram into a product of three smaller diagrams, the outside diagrams having a smaller number of l -covered lines.

B On constrained isotopy

It may be helpful to elaborate on the meaning of isotopy in Definition 3.5.1. For planar diagrams, once the vertices are labelled on the frame there is no isotopy that can obfuscate this order. The precise location of individual vertices on the frame

is not of any concern in converting between (non-unique) concrete diagrams and their (unique) underlying diagrams. For periodic diagrams, if any movement on the frame is allowed then it might seem that isotopy can untwist the full twist (on the identity element for example). However, the intermediate objects in the associated continuum would be formally ill-defined as concrete diagrams (in that it would not be possible to regard them as concrete realisations of the original diagram, or indeed of any particular diagram). It follows that the ‘natural’ embedding of the identity element is not isotopic to a twisted one in our definition of isotopy. A more general algebra arises, therefore, if we consider the fundamental objects to be (frame-fixing) isotopy classes of concrete periodic diagrams, than if we regard the corresponding diagrams as fundamental.

References

- [1] M Alvarez and P P Martin, *Towards an algebra of 2-manifold surgery*, preprint (2005).
- [2] M A Armstrong, *Basic topology*, McGraw Hill, 1979.
- [3] R J Baxter, *Exactly solved models in statistical mechanics*, Academic Press, New York, 1982.
- [4] A.A. Beilinson, J.N. Bernstein, and P. Deligne, *Faisceaux pervers*, Analyse et topologie sur les espaces singuliers, vol. 1, Astérisque, no. 100, 1981.
- [5] G M Bergman, *The diamond lemma for ring theory*, Adv. Math. **29** (1978), 178–218.
- [6] M Bloss, *g-colored partition algebras as centralizer algebras of wreath products*, Journal of Algebra **265** (2003), 690–710.
- [7] R Brauer, *On algebras which are connected with the semi-simple continuous groups*, Annals of Mathematics **38** (1937), 854–872.
- [8] I Cherednik, *A unification of Knizhnik–Zamolodchikov and Dunkl operators via affine Hecke algebras*, Invent Math **106** (1991), 411–431.
- [9] C Chevalley, *Fundamental concepts of algebra*, Academic Press, 1956.
- [10] E Cline, B Parshall, and L Scott, *Finite-dimensional algebras and highest weight categories*, J. reine angew. Math. **391** (1988), 85–99.
- [11] A G Cox, J J Graham, and P P Martin, *The blob algebra in positive characteristic*, J Algebra **266** (2003), 584–635.
- [12] A G Cox, P P Martin, A E Parker, and C C Xi, *Representation theory of towers of recollement: theory, notes and examples*, preprint to appear in *J Algebra* (math.RT/0411395), 2003.
- [13] C W Curtis and I Reiner, *Representation theory of finite groups and associative algebras*, Wiley Interscience, New York, 1962.

- [14] J de Gier, *Loops, matchings and alternating-sign matrices*, 14th International Conference on Formal Power Series and Algebraic Combinatorics (Melbourne 2002), math.CO/0211285 (2002).
- [15] K. Erdmann and R.M. Green, *On representations of affine Temperley–Lieb algebras, II*, Pacific J. Math. **191** (1999), 243–273.
- [16] C K Fan and R M Green, *On the affine Temperley–Lieb algebras*, J. LMS **60** (1999), 366–380.
- [17] F M Goodman, P de la Harpe, and V F R Jones, *Coxeter graphs and towers of algebras*, Math Sci Research Inst Publications 14, Springer–Verlag, Berlin, 1989.
- [18] J J Graham, *Modular representations of Hecke algebras and related algebras*, Ph.D. thesis, Mathematics, University of Sydney, 1995.
- [19] J. J. Graham and G. I. Lehrer, *Cellular algebras*, Invent. Math. **123** (1996), 1–34.
- [20] ———, *The representation theory of affine Temperley–Lieb algebras*, L’Enseignement Mathématique **44** (1998), 173–218.
- [21] ———, *Diagram algebras, Hecke algebras and decomposition numbers at roots of unity*, Annales Scientifiques de l’École Normale Supérieure **36** (2003), no. 4, 479–524.
- [22] J A Green, *Polynomial representations of GL_n* , Springer-Verlag, Berlin, 1980.
- [23] R. M. Green, *Generalized Temperley–Lieb algebras and decorated tangles*, J. Knot Theory Ramifications **7** (1998), 155–171.
- [24] R M Green, *On representations of affine Temperley–Lieb algebras*, Canad Math Soc Conference Proc **24** (1998), 245–261.
- [25] ———, *On planar algebras arising from hypergroups*, J. Algebra **263** (2003), 126–150.
- [26] R. Häring-Oldenburg, *The reduced Birman–Wenzl algebra of Coxeter type B*, J Algebra **213** (1999), 437–466.
- [27] J E Humphreys, *Reflection groups and Coxeter groups*, Cambridge University Press, 1990.
- [28] G D James and A Kerber, *The representation theory of the symmetric group*, Addison-Wesley, London, 1981.
- [29] V F R Jones, *Planar algebras, I*, unpublished.
- [30] ———, *A quotient of the affine Hecke algebra in the Brauer algebra*, L’Enseignement Mathématique **40** (1994), 313–344.

- [31] A-A A Jucys, *Symmetric polynomials and the centre of the symmetric group ring*, Rep Math Phys **5** (1974), 107–112.
- [32] S Koenig and C C Xi, *When is a cellular algebra quasi-hereditary?*, Mathematische Annalen **315** (1999), 281–293.
- [33] D Levy, *Algebraic structure of translation-invariant spin-1/2 XXZ and q-Potts quantum chains*, Phys Rev Lett **67** (1991), 1971–1974.
- [34] G Lusztig, *Affine Hecke algebras and their graded version*, J Am Math Soc **2:3** (1989), 599–685.
- [35] P P Martin, *Potts models and related problems in statistical mechanics*, World Scientific, Singapore, 1991.
- [36] ———, *Temperley–Lieb algebras for non–planar statistical mechanics — the partition algebra construction*, Journal of Knot Theory and its Ramifications **3** (1994), no. 1, 51–82.
- [37] ———, *Pascal’s triangle and word bases for blob algebra ideals*, preprint (1995).
- [38] ———, *The structure of the partition algebras*, J Algebra **183** (1996), 319–358.
- [39] P P Martin and S Ryom-Hansen, *Virtual algebraic Lie theory: Tilting modules and Ringel duals for blob algebras*, Proc LMS **89** (2004), 655–675, (math.RT/0210063).
- [40] P P Martin and H Saleur, *On an algebraic approach to higher dimensional statistical mechanics*, Commun. Math. Phys. **158** (1993), 155–190.
- [41] ———, *The blob algebra and the periodic Temperley–Lieb algebra*, Lett. Math. Phys. **30** (1994), 189–206.
- [42] P P Martin and D Woodcock, *On the structure of the blob algebra*, J Algebra **225** (2000), 957–988.
- [43] ———, *Generalized blob algebras and alcove geometry*, LMS J Comput Math **6** (2003), 249–296, (math.RT/0205263).
- [44] P P Martin, D Woodcock, and D Levy, *A diagrammatic approach to Hecke algebras of the reflection equation*, J Phys A **33** (2000), 1265–1296.
- [45] E E Moise, *Geometric topology in dimensions 2 and 3*, Graduate Texts in Mathematics 47, Springer-Verlag, New York, 1977.
- [46] G E Murphy, *A new construction of Young’s seminormal representation of the symmetric group*, J Algebra **69** (1981), 287–291.
- [47] M Nazarov, *Young’s orthogonal form for Brauer’s centralizer algebra*, J Algebra **182** (1996), 664–693.
- [48] A Nichols, V Rittenberg, and J de Gier, *One-boundary Temperley–Lieb algebras in the XXZ and loop models*, J Stat (2005, to appear), cond-mat/0411512.

- [49] R Orellana and A Ram, *Affine braids, Markov traces and the category O* , Newton Institute preprint NI01032-SFM, 2001.
- [50] V Pasquier and H Saleur, *Common structures between finite systems and conformal field theories through quantum groups*, Nucl Phys B **330** (1990), 523.
- [51] H Rui and C C Xi, *The representation theory of cyclotomic Temperley–Lieb algebras*, Comment Math Helv **79** (2004), 427–450.
- [52] Siddhartha Sahi, *Nonsymmetric Koornwinder polynomials and duality*, Annals of Mathematics **150** (1999), 267–282.
- [53] H N V Temperley and E H Lieb, *Relations between percolation and colouring problems and other graph theoretical problems associated with regular planar lattices: some exact results for the percolation problem*, Proceedings of the Royal Society A **322** (1971), 251–280.
- [54] T tom Dieck, *Symmetrische Brücken und Knotentheorie zu den Dynkin-diagrammen vom type B* , J Reine angew Math **451** (1994), 71–88.
- [55] H Weyl, *Classical groups*, Princeton, Princeton, 1946, ch.III–V.

1-reflection line

0-reflection line

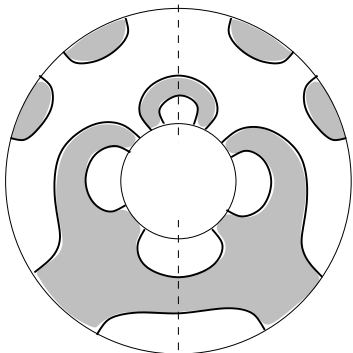

1-reflection line

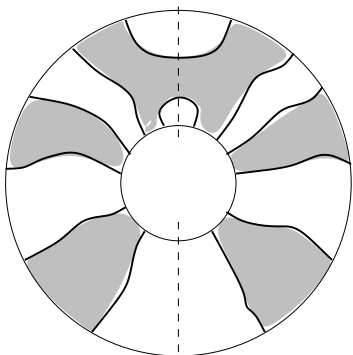

0-reflection line