

CYCLOTOMIC BIRMAN–WENZL–MURAKAMI ALGEBRAS, I: FREEDNESS AND REALIZATION AS TANGLE ALGEBRAS

FREDERICK M. GOODMAN AND HOLLY HAUSCHILD MOSLEY

March, 2008

ABSTRACT. The cyclotomic Birman-Wenzl-Murakami algebras are quotients of the affine BMW algebras in which the affine generator satisfies a polynomial relation. We show that the cyclotomic BMW algebras are free modules over any admissible, integral ground ring, and that they are isomorphic to cyclotomic versions of the Kauffman tangle algebras.

CONTENTS

1. Introduction	1
2. A new basis of the affine Birman-Wenzl-Murakami algebra	7
3. The cyclotomic BMW and Kauffman tangle algebras	27
4. Weak admissibility and the Markov trace	30
5. Admissibility	36
6. Remarks on the affine and cyclotomic Hecke algebras	38
References	45

1. INTRODUCTION

This paper and the companion paper [11] continue the study of affine and cyclotomic Birman–Wenzl–Murakami (BMW) algebras, which we began in [10].

1.1. **Background.** The origin of the BMW algebras was in knot theory. Kauffman defined [15] an invariant of regular isotopy for links in S^3 , determined by certain skein relations. Birman and Wenzl [5] and independently Murakami [23] then defined a family of quotients of the braid group algebras, and showed that Kauffman’s invariant could be recovered from a trace on these algebras. These (BMW) algebras were defined by generators and relations, but were implicitly

2000 *Mathematics Subject Classification.* 57M25, 81R50.

modeled on certain algebras of tangles whose definition was subsequently made explicit by Morton and Traczyk [21], as follows: Let S be a commutative unital ring with invertible elements ρ , q , and δ_0 satisfying $\rho^{-1} - \rho = (q^{-1} - q)(\delta_0 - 1)$. The *Kauffman tangle algebra* $KT_{n,S}$ is the S -algebra of framed (n, n) -tangles in the disc cross the interval, modulo Kauffman skein relations:

- (1) Crossing relation: $\begin{array}{c} \diagdown \\ \diagup \end{array} - \begin{array}{c} \diagup \\ \diagdown \end{array} = (q^{-1} - q) \left(\begin{array}{c} \diagdown \\ \diagdown \end{array} - \begin{array}{c} \diagup \\ \diagup \end{array} \right)$.
- (2) Untwisting relation: $\begin{array}{c} \text{left twist} \\ \text{right twist} \end{array} = \rho \quad \Bigg| \quad \text{and} \quad \begin{array}{c} \text{right twist} \\ \text{left twist} \end{array} = \rho^{-1} \quad \Bigg|$.
- (3) Free loop relation: $T \cup \bigcirc = \delta_0 T$.

Morton and Traczyk [21] showed that the n -strand algebra $KT_{n,S}$ is free of rank $(2n - 1)!!$ as a module over S , and Morton and Wassermann [22] proved that the BMW algebras and the Kauffman tangle algebras are isomorphic.

It is natural to “affinize” the BMW algebras to obtain BMW analogues of the affine Hecke algebras of type A , see [2]. The affine Hecke algebra can be realized geometrically as the algebra of braids in the annulus cross the interval, modulo Hecke skein relations; this suggests defining the affine Kauffman tangle algebra $\widehat{KT}_{n,S}$ as the algebra of framed (n, n) -tangles in the annulus cross the interval, modulo Kauffman skein relations. Turaev [27] showed that the resulting algebra of $(0, 0)$ -tangles is a (commutative) polynomial algebra in infinitely many variables, so it makes sense to absorb this polynomial algebra into the ground ring. (The ground ring gains infinitely many parameters δ_j ($j \geq 1$) corresponding to the generators of the polynomial algebra.) With this, one arrives at the definition of the affine Kauffman tangle algebra given in [10], see Definition 2.1 below. On the other hand, Häring–Oldenburg [13] defined an affine version of the BMW algebras by generators and relations. In [10], we showed that Häring–Oldenburg’s affine BMW algebras are isomorphic to the affine Kauffman tangle algebras, and we showed that these algebras are free modules over their ground ring, with a basis reminiscent of a well-known basis of affine Hecke algebras.

The affine BMW algebras arise naturally in several different contexts:

- *Knot theory in the solid torus.* The Kauffman skein relations determine a family of invariants of links in the solid torus [27]; the family has infinitely many parameters. Lambropoulou [16], [17] has shown that the Jones paradigm [14] for link invariants in S^3 can be extended to links in the solid torus; namely, invariants of links in the solid torus can be derived from Markov traces on the

braid group of the annulus (which coincides with the Artin braid group of type B). The Kauffman-type invariants for links in the solid torus can be recovered from the Markov trace on affine and cyclotomic BMW algebras. The existence and uniqueness of the Markov trace on these algebras is discussed in [10] and in this paper. The infinitely many parameters for Kauffman-type invariants enter into the definition of the affine BMW algebras; for each choice of parameters, the unique Markov trace on the corresponding affine BMW algebra yields the Kauffman-type invariant with those parameters.

- *Quantum groups and R -matrices.* The following is a brief summary of results from [26]. Let \mathfrak{g} be a complex simple Lie algebra, and $U_q\mathfrak{g}$ the quantum universal enveloping algebra of \mathfrak{g} . Let M, V be finite dimensional $U_q\mathfrak{g}$ modules. Let $\check{R}_i = \check{R}_{V,V}$ acting on the i -th and $i+1$ -st tensor places in $V^{\otimes f}$, and let \check{R}_0^2 denote $\check{R}_{V,M}\check{R}_{M,V}$ action on $M \otimes V$. Then $\sigma_i \mapsto \check{R}_i$ gives a representation of the f -string braid group in $\text{End}_{U_q\mathfrak{g}}(V^{\otimes f})$. The assignments $\sigma_i \mapsto \check{R}_i$ and $\sigma_0^2 \mapsto \check{R}_0^2$ determines a representation of the braid group of type B in $\text{End}_{U_q\mathfrak{g}}(M \otimes V^{\otimes f})$. Suppose \mathfrak{g} is an orthogonal or symplectic Lie algebra, M is an irreducible representation and V is the vector representation. Then the representation of the type B braid group by \check{R} matrices factors through a cyclotomic BMW algebra.
- *Representations of ordinary BMW algebras.* In the ordinary BMW algebra W_n , let $L_1 = 1$, and $L_i = g_{i-1}g_{i-2} \cdots g_2 g_1^2 g_2 \cdots g_{i-2}g_{i-1}$ for $2 \leq i \leq n$. The elements L_i are Jucys-Murphy elements for the BMW algebras. The representation theory of the BMW algebras is largely determined by the spectrum of the (mutually commuting) elements L_i and their commutation relations with the standard generators e_i, g_i of the algebras. See, for example, [19], Example 2.18, and [8].

For generic values of the parameters, the BMW algebra W_n is semisimple and has irreducible representations labeled by Young diagrams of size $n - 2f$ ($0 \leq f \leq n/2$). The irreducible representation labeled by λ has a basis indexed by up-down tableaux of length n and shape λ , that is sequence of Young diagrams beginning with the empty diagram and ending with λ , in which any two successive Young diagrams differ by the addition or deletion of a box. Fix integers $n < N$ and Young diagrams λ and μ of sizes $n - 2f$ and $N - 2k$, and consider up-down tableaux beginning with λ and ending with μ . Then the algebra generated by L_{n+1} and e_j, g_j for $n + 1 \leq j \leq N - 1$ acts on the vector

space spanned by such up–down tableaux, and affords a representation of the $(N - n)$ –strand affine BMW algebra.

Indeed, one can regard a representation of the BMW algebra on a space spanned by up–down tableaux as pieced together from representations of two–strand affine BMW algebras generated by triples $\{L_j, e_j, g_j\}$ acting on up–down tableaux of length 2. This point of view (applied to representations of the symmetric group) was stressed by Okounkov and Vershik [25], who used it to reconstruct the representation theory of the symmetric groups *ab initio*.

1.2. Cyclotomic BMW algebras. In this paper and the companion paper [11] we consider cyclotomic BMW algebras, which are the BMW analogues of cyclotomic Hecke algebras [2]. The affine BMW algebras have a distinguished generator x_1 , which, in the geometric (Kauffman tangle) picture is represented by a braid with one strand wrapping around the hole in the annulus cross interval. The cyclotomic BMW algebra $W_{n,S,r}$ is defined to be the quotient of the affine BMW algebra $\widehat{W}_{n,S}$ in which the generator x_1 satisfies a monic polynomial equation

$$(1.1) \quad x_1^r + \sum_{k=0}^{r-1} a_k x_1^k = 0.$$

with coefficients in S .¹ The cyclotomic BMW algebras were also introduced by Häring-Oldenburg in [13].

In the geometric (Kauffman tangle) picture, it is more natural to convert this relation into a local skein relation:

$$(1.2) \quad T_r + \sum_{k=0}^{r-1} a_k T_k = 0,$$

whenever T_0, T_1, \dots, T_r are affine tangle diagrams that are identical in the exterior of some disc E and $T_k \cap E$ consists of one strand wrapping k times around the hole in the annulus cross interval; i.e. $T_k \cap E$ “equals” x_1^k . The cyclotomic Kauffman tangle algebra $KT_{n,S,r}$ is defined to be the quotient of the affine Kauffman tangle algebra $\widehat{KT}_{n,S}$ by the cyclotomic skein relation.

A priori, the ideal in $\widehat{KT}_{n,S} \cong \widehat{W}_{n,S}$ generated by the cyclotomic skein relation 1.2 is larger than the ideal generated by the polynomial relation 1.1, so we have a surjective, but not evidently injective homomorphism $\varphi : W_{n,S,r} \rightarrow KT_{n,S,r}$.

Another point of view that underlines the a priori distinction between $W_{n,S,r}$ and $KT_{n,S,r}$ is the following: Consider the affine Kauffman tangle category, with

¹Actually, we will assume that the polynomial splits in S .

objects the natural numbers $0, 1, 2, \dots$ and with $\text{Hom}(k, \ell)$ defined as the S -module of (k, ℓ) -tangles in the annulus cross the interval, modulo Kauffman skein relations; thus $\widehat{KT}_{n,S} = \text{End}(n)$ in this category. Then $\widehat{KT}_{*,S} = \bigoplus_{k,\ell} \text{Hom}(k, \ell)$ is a (non-unital) algebra, containing each $\widehat{KT}_{n,S}$ as a subalgebra. (Regard the elements of $\widehat{KT}_{*,S}$ as infinite matrices with (k, ℓ) entry in $\text{Hom}(\ell, k)$.) In $\widehat{KT}_{*,S}$, let I_* be the ideal generated by the polynomial relations 1.1, *one relation for each n* . (There is a y_1 in each $\widehat{KT}_{n,S} = \text{End}(n)$, and a corresponding relation.) Set $KT_{*,S,r} = \widehat{KT}_{*,S}/I_*$. Then the algebra $KT_{*,S,r}$ is the algebra associated to a quotient category $KT(r)$, and $KT_{n,S,r}$ (as previously defined) can be identified with $\text{End}(n)$ in this category.

1.3. Admissibility. The cyclotomic BMW algebras and Kauffman tangle algebras can be defined over an arbitrary commutative unital ring S with parameters ρ, q, δ_j ($j \geq 0$), and u_1, \dots, u_r (roots of the polynomial satisfied by $y_1 = \rho x_1$), assuming that ρ, q, δ_0 and u_1, \dots, u_r are invertible, and $\rho^{-1} - \rho = (q^{-1} - q)(\delta_0 - 1)$. However, unless the parameters satisfy additional relations, the identity element $\mathbf{1}$ of the cyclotomic Kauffman tangle algebras will be a torsion element over S ; if S is a field (and the additional relations do not hold) then $\mathbf{1} = 0$, so $KT_{n,S,r}$ becomes trivial. The additional conditions are called “weak admissibility;” see Section 4 for details.

In order to obtain substantial results about the cyclotomic BMW and Kauffman tangle algebras, it seems necessary to impose stronger conditions on the ground ring S . An appropriate condition, known as “admissibility,” was introduced by Wilcox and Yu in [31]. Their condition has a simple formulation in terms of the representation theory of the 2-strand algebra $W_{2,S,r}$, and also translates into explicit relations on the parameters. See Section 5 for further details.

1.4. Results. The main results of this paper and [11] is that if the ground ring S is an integral domain and admissible in the sense of Wilcox and Yu, then $W_{n,S,r} \cong KT_{n,S,r}$, and, moreover, these algebras are free S -modules of rank $r^n(2n - 1)!!$. The proof of these results has a topological component, which is given in this paper, and an algebraic component, which is given in [11].

Our topological argument provides a straightening procedure for affine tangle diagrams that allows any affine tangle diagram to be expressed as a linear combination of affine tangle diagrams in a certain normal form (modulo Kauffman skein relations).

The straightening procedure has two important consequences: First, it allows us to produce a spanning set \mathbb{A}'_r of cardinality $r^n(2n-1)!!$ for the cyclotomic BMW algebra $W_{n,S,r}$. Second, it allows us to show that, if S is weakly admissible, then $KT_{0,S,r}$ is a free S -module of rank 1. Freeness of $KT_{0,S,r}$ implies the existence of the “Markov trace” $\varepsilon : KT_{n,S,r} \rightarrow KT_{0,S,r} \cong S$, which is defined on the level of affine tangle diagrams by “closing” diagrams:

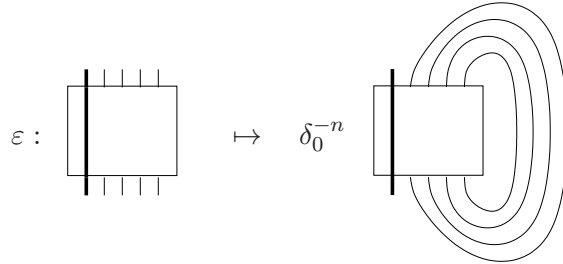

(Freeness of $KT_{0,S,r}$, or the existence of the Markov trace, immediately implies the existence of cyclotomic Kauffman link invariants in the solid torus, cf. [22, 18, 27].)

To achieve the main results, it remains to show that the spanning set $\varphi(\mathbb{A}'_r)$ of the cyclotomic Kauffman tangle algebra $KT_{n,S,r}$ is linearly independent, when the ground ring S is an admissible integral domain. This is done in [11]. We give a brief summary of the strategy. First, we show that there is a universal admissible integral domain \overline{R} , such that every admissible integral domain is a quotient of \overline{R} . We then analyze the representation theory of the cyclotomic BMW algebras defined over the field of fractions F of \overline{R} , by adapting the inductive method of Wenzl from [5, 28, 29]. This analysis shows that $KT_{n,F,r} \cong W_{n,F,r}$, and that the dimension of these algebras over F is $r^n(2n-1)!!$. A relatively simple argument (given in Section 5 of this paper) then shows that for any admissible integral domain S , we have $KT_{n,S,r} \cong W_{n,S,r}$, and these algebras are free of rank $r^n(2n-1)!!$ over S .

An outline of the paper is as follows: In Section 2 we discuss the straightening procedure for affine tangle diagrams and its consequences. In Section 3, the cyclotomic algebras are introduced. In Section 4, we discuss weak admissibility and the existence of the Markov trace. In Section 5 we summarize [11] and explain how our main theorem follows by combining the results of this paper with [11]. In the final section of the paper, we remark that a similar straightening procedure can be applied to the affine and cyclotomic Hecke algebras, allowing us to recover a result of Lambropoulou [18] with a less computationally intensive proof.

1.5. Related work, and acknowledgments. Wilcox and Yu have been studying the same material independently and have obtained similar (and slightly stronger) results [31, 32, 30]. We are indebted to Wilcox and Yu for pointing out an error in a previous preprint version of our work, which required us to substantially rework the algebraic (linear independence) component of the arguments. In fact, we had to adopt a completely different strategy for proving linear independence. Meanwhile, Wilcox and Yu [32, 30] were able to make our original strategy work, using a refined analysis of their admissibility condition.

We would also like to mention here recent work of Ariki, Mathas and Rui on the “cyclotomic Nazarov–Wenzl algebras” [3], which are cyclotomic quotients of the degenerate affine BMW algebras introduced by Nazarov [24]. Ideas from [3] play an important role in the companion paper [11], and thus in our project as a whole.

It is shown in [9] and [32] that cyclotomic BMW algebras defined over integral admissible ground rings are cellular in the sense of Graham and Lehrer [12]. The proof in [9] relies on this paper and [11].

2. A NEW BASIS OF THE AFFINE BIRMAN-WENZL-MURAKAMI ALGEBRA

2.1. The affine Kauffman tangle and BMW algebras. We begin by recalling the definitions of the affine Birman-Wenzl-Murakami algebra and of the affine Kauffman tangle algebra.

The *affine Kauffman tangle algebra* \widehat{KT}_n is the algebra of framed (n, n) -tangles in $A \times I$, where A is the annulus and I the interval, modulo the Kauffman skein relations. This algebra can be described in terms of *affine tangle diagrams*, as follows.

An ordinary tangle diagram is a piece of knot diagram in the rectangle $\mathcal{R} = I \times I$ consisting of some number of closed curves and some number of topological intervals. The intervals must have their endpoints on the upper or lower edge of the rectangle. A (k, n) -tangle diagram is one with k vertices (endpoints of intervals) on the upper edge of \mathcal{R} and n vertices on the lower edge. We regard two ordinary tangle diagrams as equivalent if they are regularly isotopic (i.e. connected by a sequence of Reidemeister moves of types II and III, followed by an isotopy of \mathcal{R} , see Figure 2.1). One can compose a (k, n) -tangle diagram a and an (n, m) -tangle diagram b by “stacking” a over b . This yields a monoid structure on regular isotopy classes of (n, n) -tangle diagrams.

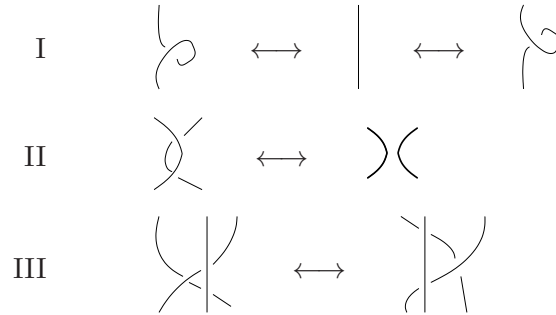

FIGURE 2.1. Reidemeister moves

An *affine (k, n) -tangle diagram* is an ordinary $(k + 1, n + 1)$ -tangle diagram which includes a distinguished vertical curve. We will draw affine tangle diagrams with the distinguished curve drawn as a thickened vertical segment. We refer to the distinguished curve as the “flagpole”, and to the other curves in the diagram as “ordinary strands”. A picture of a typical affine tangle diagram is given in Figure 2.2. Regular isotopy classes of affine (n, n) -tangle diagrams are closed under composition. We let $\widehat{\mathcal{U}}(n, n)$ denote the monoid of regular isotopy classes of affine (n, n) -tangle diagrams under composition.

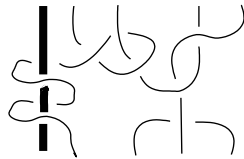
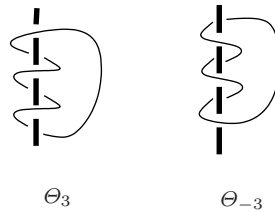

FIGURE 2.2. Affine tangle diagram

For $j \geq 0$, let Θ_j (resp. Θ_{-j}) denote the (regular isotopy class of) the closed curve with no self-crossings that winds j times around the flagpole in the positive sense (resp. in the negative sense).



Note that Θ_0 is represented by a closed curve that does not intersect the flagpole.

Definition 2.1. Let S be a commutative unital ring containing elements ρ , q , and δ_j , $j \geq 0$, with ρ , q , and δ_0 invertible, satisfying the relation $\rho^{-1} - \rho = (q^{-1} - q)(\delta_0 - 1)$. The *affine Kauffman tangle algebra* $\widehat{KT}_{n,S} = \widehat{KT}_{n,S}(\rho, q, \delta_0, \delta_1, \dots)$ is the monoid algebra $S\widehat{U}(n, n)$ modulo the following relations:

(1) (Crossing relation)

$$\begin{array}{c} \diagup \diagdown \\ \diagdown \diagup \end{array} - \begin{array}{c} \diagdown \diagup \\ \diagup \diagdown \end{array} = (q^{-1} - q) \left(\begin{array}{c} \diagdown \diagup \\ \diagdown \diagup \end{array} - \begin{array}{c} \diagup \diagdown \\ \diagup \diagdown \end{array} \right).$$

(2) (Untwisting relation)

$$\begin{array}{c} \diagup \diagdown \\ \diagup \diagdown \end{array} = \rho \quad \Bigg| \quad \text{and} \quad \begin{array}{c} \diagdown \diagup \\ \diagdown \diagup \end{array} = \rho^{-1} \quad \Bigg|.$$

(3) (Free loop relations) For $j \geq 0$, $T \cup \Theta_j = \rho^{-j} \delta_j T$, where $T \cup \Theta_j$ is the union of an affine tangle diagram T and a copy of the curve Θ_j , such that there are no crossings between T and Θ_j .

Remark 2.2. The idea behind relation (3) is the following: If one only imposes relations (1) and (2), then the $(0, 0)$ -affine tangle algebra is the polynomial algebra generated by Θ_j ($j \geq 0$), over whatever ground ring one is working, and embeds in the center of the (n, n) -tangle algebra. Therefore, it makes sense to absorb the $(0, 0)$ -affine tangle algebra into the ground ring, and this is accomplished by relation (3).

We now introduce the affine Birman–Wenzl–Murakami (BMW) algebra. As above, let S be a commutative unital ring with elements ρ , q , and δ_j , $j \geq 0$, with ρ , q , and δ_0 invertible, satisfying the relation $\rho^{-1} - \rho = (q^{-1} - q)(\delta_0 - 1)$.

Definition 2.3. The *affine Birman–Wenzl–Murakami algebra* $\widehat{W}_{n,S}$ is the S algebra with generators $y_1^{\pm 1}$, $g_i^{\pm 1}$ and e_i ($1 \leq i \leq n - 1$) and relations:

(1) (Inverses) $g_i g_i^{-1} = g_i^{-1} g_i = 1$ and $y_1 y_1^{-1} = y_1^{-1} y_1 = 1$.

(2) (Idempotent relation) $e_i^2 = \delta_0 e_i$.

(3) (Type B braid relations)

(a) $g_i g_{i+1} g_i = g_{i+1} g_i g_{i+1}$ and $g_i g_j = g_j g_i$ if $|i - j| \geq 2$.

(b) $y_1 g_1 y_1 g_1 = g_1 y_1 g_1 y_1$ and $y_1 g_j = g_j y_1$ if $j \geq 2$.

(4) (Commutation relations)

(a) $g_i e_j = e_j g_i$ and $e_i e_j = e_j e_i$ if $|i - j| \geq 2$.

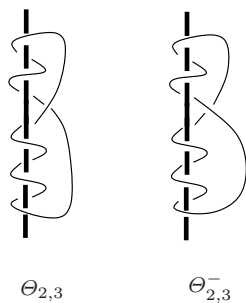

FIGURE 2.3.

Proof. Point (1) follows from introducing a twist at the top of Θ_{-j} :

The proof of (2) is the same. The tangle obtained by smoothing the crossing in $\Theta_{a,b}$ horizontally is $\Theta_a\Theta_{-b}$, and the tangle obtained by smoothing the crossing vertically is Θ_{a-b} , while $\Theta_{a,b}^- = \rho^2\Theta_{a+1,b-1}$. Thus the Kauffman skein relation gives $\Theta_{a,b} = \rho^2\Theta_{a+1,b-1} + (q^{-1} - q)(\Theta_a\Theta_{-b} - \Theta_{a-b})$. An induction based on points (1)–(3) yields (4). \square

2.3. Flagpole–descending affine tangle diagrams.

Definition 2.7. A *simple winding* is a piece of an affine tangle diagram with one ordinary strand, without self-crossings, regularly isotopic to the intersection of one of the affine tangle diagrams X_1 or X_1^{-1} with a small neighborhood of the flagpole, as in the following figure.

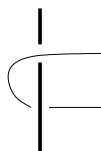

Definition 2.8. An affine tangle diagram is in *standard position* if:

- (1) It has no crossings to the left of the flagpole.
- (2) There is a neighborhood of the flagpole whose intersection with the tangle diagram is a union of simple windings.

- (3) The simple windings have no crossings and are not nested. That is, between the two crossings of a simple winding with the flagpole, there is no other crossing of a strand with the flagpole.

See Figure 2.4.

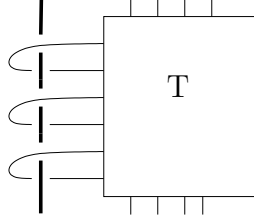

FIGURE 2.4. Affine tangle diagram in standard position

Lemma 2.9 ([10]). *Any affine tangle diagram is regularly isotopic to an affine tangle diagram in standard position.*

Fix an integer $n \geq 1$. Recall that an (n, n) -affine tangle diagram is a figure contained in $I \times I$. For fixed points $0 < a_1 < \dots < a_n < 1$ in I , we write $\mathbf{i} = (a_i, 1)$ and $\bar{\mathbf{i}} = (a_i, 0)$; we refer to these points as *vertices*. We order the vertices of (n, n) -affine tangle diagrams by $\mathbf{1} < \mathbf{2} < \dots < \mathbf{n} < \bar{\mathbf{n}} < \dots < \bar{\mathbf{2}} < \bar{\mathbf{1}}$. That is, the vertices are taken in clockwise order around the boundary of $I \times I$.

Definition 2.10. An *orientation* of an affine or ordinary tangle diagram is a linear ordering of the strands, a choice of an orientation of each strand, and a choice of an initial point on each closed loop.

An orientation determines a way of traversing the tangle diagram; namely, the strands are traversed successively, in the given order and orientation (the closed loops being traversed starting at the assigned initial point).

Definition 2.11. A *standard orientation* of an ordinary or affine (n, n) -tangle diagram is one in which

- (1) each non-closed strand is oriented from its lower numbered vertex to its higher numbered vertex.
- (2) The non-closed strands precede the closed loops.
- (3) The non-closed strands are ordered according to the order of the initial vertices.

If a tangle diagram has no closed loops, then it has a unique standard orientation.

Definition 2.12. An oriented affine or ordinary tangle diagram is *stratified* if

- (1) there is a linear ordering of the strands such that if strand s precedes strand t in the order, then each crossing of s with t is an over-crossing.
- (2) each strand is totally descending, that is, each self-crossing of the strand is encountered first as an over-crossing as the strand is traversed according to the orientation.

We call the corresponding ordering of the strands the *stratification order*.

Note that a stratification order need not coincide with the ordering of strands determined by the orientation.

Lemma 2.13. *Endow affine (n, n) -tangles with an orientation and a stratification order, each determined by some rule depending on the vertices of the strands. $\widehat{KT}_{n,S}$ is spanned by affine (n, n) -tangle diagrams in standard position that are stratified with respect to the given stratification order.*

Proof. We already know that $\widehat{KT}_{n,S}$ is spanned by affine tangle diagrams in standard position. Observe that changing or smoothing a crossing of ordinary strands leaves such a diagram in standard position. In the following paragraph “tangle” means “affine tangle diagram in standard position”.

The proof is by induction on the number of crossings of ordinary strands. If a tangle has no crossings, it is already stratified. Let T be a tangle with $l \geq 1$ crossings, and assume that any tangle with fewer than l crossings is in the span of stratified tangles. The stratified tangle S which differs from T only by reversing some number of crossings is congruent to T modulo the span of tangles with fewer crossings, hence modulo the span of stratified tangles. \square

Definition 2.14. An oriented, stratified affine tangle diagram T in standard position is said to be *flagpole descending* if it satisfies the following conditions:

- (1) T is not regularly isotopic to an affine tangle diagram in standard position with fewer simple windings.
- (2) The strands of T have no self-crossings.
- (3) As T is traversed according to the orientation, successive crossings of ordinary strands with the flagpole descend the flagpole.

Remark 2.15. In a flagpole descending affine tangle diagram:

- (1) Of the four types of oriented simple windings (see Figure 2.5), only types (a) and (c) can occur. Moreover, a strand can have windings of one type only, since otherwise the number of simple windings could be reduced by regular isotopy.
- (2) For each strand s there is a neighborhood N of an interval on the flagpole such that: N does not intersect any strand other than s , all crossings of s with the flagpole are contained in N , and the intersection of s with N is regularly isotopic to X_1^k for some $k \in \mathbb{Z}$.

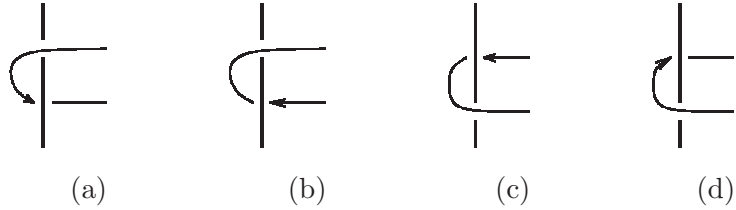

FIGURE 2.5. Types of oriented simple windings

Our immediate goal is to show that $\widehat{KT}_{n,S}$ is spanned by affine tangle diagrams without closed strands that are stratified (with an arbitrary stratification order) and flagpole descending with respect to the standard orientation.

Let D be the circle of radius $1/3$, centered at $((a_1 + a_n)/2, 1/2)$. Planar isotopy alone can transform any affine (n, n) -tangle diagram T in standard position so that

- D lies transversal to T ,
- each vertex is connected by a straight line segment to a point of D ,
- no crossings of ordinary strands occur outside of D , and
- the part of the affine tangle diagram outside of D consists only of simple windings beginning and ending on D and line segments connecting D with the vertices.

See Figure 2.6. Call a representative affine tangle diagram in this form a *circular form* of the affine tangle diagram T .

Let T be an (n, n) -affine tangle diagram in circular form. If k is the number of simple windings in T , then T intersects D in $2(n + k)$ points. The $2k$ points of intersection incident with simple windings will be called *winding points* and

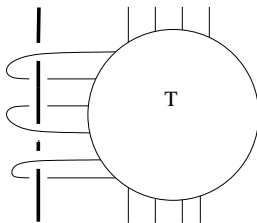

FIGURE 2.6. Affine tangle diagram in circular form

those connected by a line segment with a vertex will be called *vertex points*. The $2(n + k)$ points of intersection of D with T are connected in pairs by curves running through the interior of D , which we call D -arcs.

Definition 2.16. A *tight* affine tangle diagram is an affine tangle diagram in circular form in which every D -arc is straight line segment.

Lemma 2.17. *Every stratified affine tangle diagram T in standard position is ambient isotopic to a tight affine tangle diagram T' . Moreover, T' has at most as many crossings as T .*

Proof. As observed above, a stratified affine tangle diagram in standard position is equivalent by planar isotopy to a diagram T in circular form. Since T is stratified, its D -arcs can be lifted slightly out of the plane so that they lie at different levels above the plane. Each D -arc is unknotted, so it can be changed by ambient isotopy to a straight line segment. (It may be necessary to adjust the positions of intersections of T with D to avoid triple intersections of D -arcs.)

Let T and T' be ambient isotopic affine tangle diagrams in circular form, with T' tight. Let s, t be two D -arcs in T and let s', t' be the corresponding D -arcs in T' (with the same endpoints on D). Then s' and t' have exactly one crossing in T' if the endpoints of t' lie on opposite sides of s' (and no crossings otherwise), while s and t have at least one crossing if the endpoints of t lie on opposite sides of s . Thus T' has at most as many crossings as T . \square

Consider an affine (n, n) -tangle diagram T in circular form, with k simple windings, stratified with respect to a standard orientation and some stratification order. The $2n$ vertex points and the $2k$ winding points of T lie on disjoint arcs of the circle D . Let p_1, \dots, p_{2k} be the winding points listed according to their position on D , in counterclockwise order. Let w_1, \dots, w_{2k} be the winding points listed according to their order in the orientation of T . There is a permutation

$\sigma = \sigma(T)$ of $\{1, \dots, 2k\}$ such that $w_i = p_{\sigma(i)}$ for all i . For T to be flagpole descending, it is necessary that σ be the identity permutation; conversely, if σ is the identity permutation, then T can be reduced to a flagpole descending tangle diagram by ambient isotopy. Moreover, closed loops can be eliminated from a flagpole descending tangle by use of the free loop relation (3) in Definition 2.1 (and Lemma 2.6.)

Proposition 2.18. *Endow affine (n, n) -tangle diagrams with any stratification order. $\widehat{KT}_{n,S}$ is spanned by affine tangle diagrams without closed loops that are stratified according to the given stratification order and flagpole descending with respect to the standard orientation.*

Proof. We know that $\widehat{KT}_{n,S}$ is spanned by affine tangle diagrams in standard position that are stratified with respect to the given stratification order.

Let T be a stratified affine tangle diagram in standard position with m crossings of ordinary strands. Let k be the number of simple windings of T , and let p_i, w_i ($1 \leq i \leq 2k$), and $\sigma(T)$ be as in the discussion preceding the statement of the Proposition. Write $\ell(\sigma)$ for the length of a permutation σ .

If $\sigma(T)$ is the identity permutation, then T can be reduced to a flagpole descending affine tangle diagram without closed strands, by ambient isotopy and the free loop relations.

We claim that if $\sigma(T)$ is not the identity permutation, then T can be written as a sum $T = T' + T''$, where T' is an affine tangle diagram with no more than m crossings and $\ell(\sigma(T')) < \ell(\sigma(T))$; and T'' is a linear combination of affine tangle diagrams with strictly fewer than m crossings.

If the claim is established, then the result follows by a double induction. Namely, if $m = 0$, then by the claim, T is equal to an affine tangle diagram T' with no crossings and with $\ell(\sigma(T')) < \ell(\sigma(T))$. It follows by induction on the length of $\sigma(T)$ that T is equal to a multiple of a stratified, flagpole descending affine tangle diagram with no closed loops. Now suppose that T has $m \geq 1$ crossings and that $\ell(\sigma(T)) > 1$; assume inductively that any stratified affine tangle diagram S with strictly fewer than m crossings and also any stratified affine tangle diagram S with m crossings but with $\ell(\sigma(S)) < \ell(\sigma(T))$ is in the span of stratified flagpole descending affine tangle diagrams without closed loops. Now the assertion of the proposition follows immediately from this induction hypothesis and the claim.

We proceed with the proof of the claim. Since $\sigma(T)$ is not the identity permutation, let i_0 be the first index such that $\sigma(i_0) > i_0$. We consider two cases:

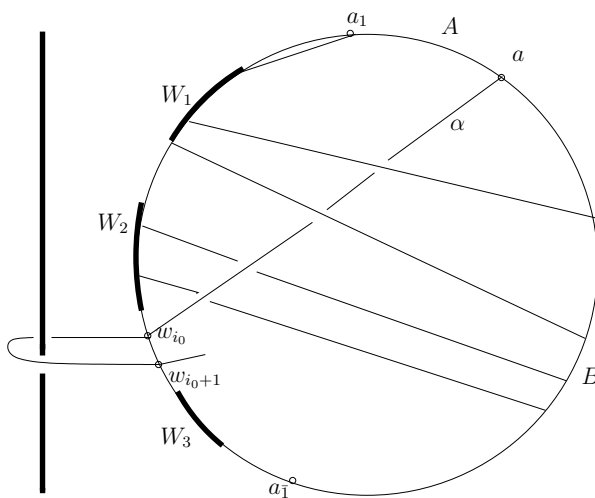

FIGURE 2.7. Sliding a winding, Case 1 before.

Case 1. The winding point w_{i_0} is the first winding point on a non-closed strand s . We will suppose that the oriented winding associated with the winding point w_{i_0} is of type (c) from Figure 2.5; the other types are handled similarly. Let W_1 be the set of winding points w_i with $i < i_0$. Let W_2 be the set of winding points w_i with $i \geq i_0 + 2$ and $\sigma(i) < \sigma(i_0)$. Let W_3 be the set of winding points w_i with $i \geq i_0 + 2$ and $\sigma(i) > \sigma(i_0 + 1)$. See Figure 2.7. Since w_{i_0} is the first winding point on s , it is connected by a D -arc α to a vertex point a .

We order the vertex points according to their position on D , in clockwise order. (The vertex points are in the same order as their associated vertices.) Let A be the set of vertex points that precede a and let B be the set of vertex points that follow a in this order.

The points of $A \cup W_1$ can be joined by D -arcs to points of $A \cup W_1$ or B . D -arcs that join $A \cup W_1$ and B cross α . The points of W_2 can be joined by D -arcs to points of W_2 , or $\{w_{i_0+1}\} \cup W_3 \cup B$. D -arcs that join W_2 with $\{w_{i_0+1}\} \cup W_3 \cup B$ cross α . This accounts for all D -arcs that cross α .

Let $T^{(1)}$ be the tight tangle diagram obtained from T by changing all crossings of α with other D -arcs incident with W_2 to under-crossings. T and $T^{(1)}$ are congruent modulo the span of diagrams with fewer crossings. $T^{(1)}$ is regularly

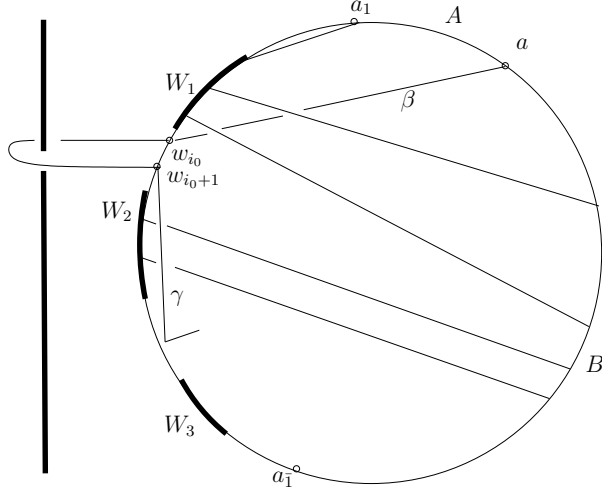

FIGURE 2.8. Sliding a winding, Case 1 after.

isotopic to the diagram $T^{(2)}$ in which the simple winding associated with w_{i_0} is slid to a position between W_1 and W_2 , as shown in Figure 2.8. In this figure, β is a D -arc connecting a with (the new position of) w_{i_0} , and γ is a curve connecting (the new position of) w_{i_0+1} with a point x in the interior of D close to the old position of w_{i_0+1} . Finally let $T^{(3)}$ be the tangle diagram obtained from $T^{(2)}$ by changing crossings of $\beta \cup \gamma$ with other strands to agree with the stratification order. Then $T^{(2)}$ and $T^{(3)}$ are congruent modulo the span of affine tangle diagrams with fewer crossings, as above.

The D -arcs that cross the D -arc β in $T^{(3)}$ are incident with $W_1 \cup A$; they correspond one-to-one with D -arcs in T incident with $W_1 \cup A$ that cross α . The D -arcs that cross the curve γ in $T^{(3)}$ are incident with W_2 ; they correspond one-to-one with D -arcs in T incident with W_2 that cross α , with the following exception: T might have a D -arc connecting w_{i_0+1} with a point of W_2 , and crossing α ; in $T^{(3)}$, this D -arc is replaced by a curve connecting the endpoint x of γ with the point of W_2 . This discussion shows that $T^{(3)}$ has at most as many crossings as T . Moreover, $\ell(\sigma(T^{(3)})) < \ell(\sigma(T))$.

Case 2. The winding point w_{i_0} is on a closed loop; or w_{i_0} is on a non-closed strand s , but it is not the first winding point on s .

Recall that the order of closed loops and the orientation and initial point on each closed loop can be chosen arbitrarily in a standard orientation. By making appropriate choices, we can assume the following without loss of generality:

- (1) Suppose that o and o' are two closed loops in T and o precedes o' in the ordering of strands. If w_i and w_j are the first winding points on o and o' , respectively, with respect to the orientation, then $\sigma(i) < \sigma(j)$.
- (2) If o is a closed loop in T , w_i is the first winding point on o and w_j is another winding point on o , then $\sigma(i) < \sigma(j)$.

With these assumptions, if w_{i_0} is on a closed loop s , then w_{i_0} is not the first winding point on s .

Again, we suppose that the oriented winding associated with the winding point w_{i_0} is of type (c) from Figure 2.5, the other types being handled similarly. Define W_1 , W_2 , and W_3 as in Case 1(a). Since w_{i_0} is not the first winding point on its strand, it is connected by a D -arc α to the last winding point in W_1 . All D -arcs that cross α are incident with W_2 , see Figure 2.9.

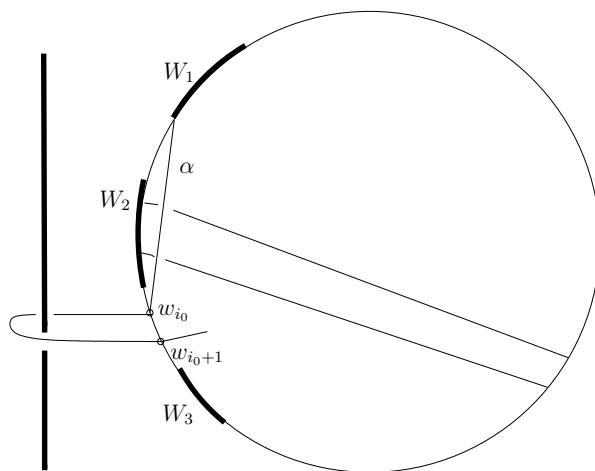

FIGURE 2.9. Sliding a winding, Case 2, before.

Now we change all the crossings of α with other D -arcs to under-crossings, and slide the simple winding associated with w_{i_0} to a position between W_1 and W_2 , to obtain a diagram $T^{(2)}$, as shown in Figure 2.10. Let $T^{(3)}$ be the tangle diagram obtained from $T^{(2)}$ by changing crossings of α with other strands to agree with the stratification order.

Then T is regularly isotopic with $T^{(3)}$ modulo the span of diagrams with fewer crossings. Moreover, $T^{(3)}$ has at most as many crossings as T , and $\ell(\sigma(T^{(3)})) < \ell(\sigma(T))$. \square

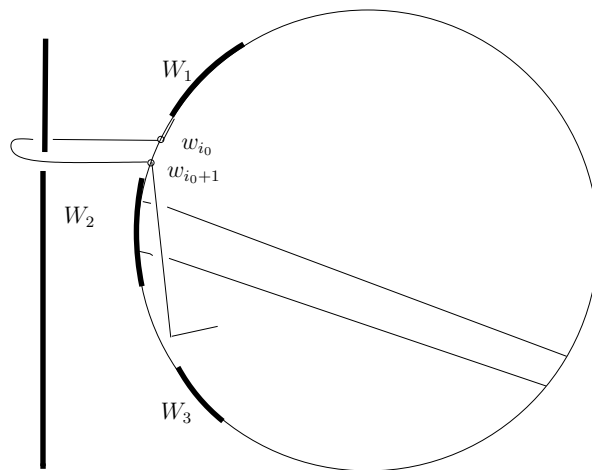

FIGURE 2.10. Sliding a winding, Case 2, after.

Proposition 2.18 can be generalized to several other orientation schemes. These generalizations will be useful here and in a subsequent paper [9]. Endow affine tangle diagrams with an arbitrary stratification. Let \mathcal{O} be any orientation scheme with the following properties:

- (1) In an affine tangle diagram oriented according to \mathcal{O} , strands are oriented from lower numbered to higher numbered vertex.
- (2) The order of strands is determined by some rule depending on the initial and final vertices of strands.
- (3) If s and t are two non-closed strands with initial vertices $i(s), i(t)$ and final vertices $f(s), f(t)$, and if both $i(s) < i(t)$ and $f(s) < f(t)$, then s precedes t in \mathcal{O} .
- (4) If an affine tangle diagram T is oriented according to \mathcal{O} and stratified, and if T has no closed loops and no crossings of ordinary strands, then T is flagpole descending.

Examples of such orientation schemes are the following:

- Standard orientation.

- Final vertex orientation: Non-closed strands are oriented from lower numbered to higher numbered vertex and ordered according to their final vertices.
- Hybrid orientation: Non-closed strands are oriented from lower numbered to higher numbered vertex and ordered as follows: Strands with initial vertex at the top of the diagram precede those with initial vertex at the bottom of the diagram. Strands with initial vertex at the top of the diagram are ordered according to their initial vertices. Strands with initial vertex at the bottom of the diagram are ordered according to their final vertices.

Proposition 2.19. *Endow affine tangle diagrams with an arbitrary stratification and with an orientation \mathcal{O} satisfying the properties listed above. Then $\widehat{KT}_{n,S}$ is spanned by affine tangle diagrams without closed loops that are stratified according to the given stratification order and flagpole descending with respect to the orientation \mathcal{O} .*

Proof. Let \mathcal{S} denote the set of affine tangle diagrams without closed loops that are stratified with respect to the given stratification order and flagpole descending with respect to the orientation \mathcal{O} . Let \mathcal{S}' denote the set of affine tangle diagrams without closed loops that are stratified with respect to the given stratification order and flagpole descending with respect to the standard orientation.

Since $\widehat{KT}_{n,S}$ is spanned by \mathcal{S}' according to Proposition 2.18, it suffices to show that \mathcal{S}' is in the span of \mathcal{S} . If an element of \mathcal{S}' has no crossings of ordinary strands, then by the assumed properties of \mathcal{O} , it is already flagpole descending with respect to \mathcal{O} .

Therefore, we can proceed by induction on the number of crossings. Suppose $T \in \mathcal{S}'$ has $\ell \geq 1$ crossings, and assume that all elements of \mathcal{S}' with fewer than ℓ crossings are in the span of \mathcal{S} . We can assume that each strand of T follows a straight line path from its initial vertex to its first crossing with the flagpole, and a straight line path from its final crossing with the flagpole to its final vertex. (We can change T by ambient isotopy to obtain such a tangle diagram.)

If T fails to be flagpole descending with respect to \mathcal{O} , then it has two strands s and t such that s precedes t in the standard orientation but s follows t in the orientation \mathcal{O} , and, moreover, such that the windings of s with the flagpole lie just above the windings of t with the flagpole. (More formally: there is a

neighborhood N of an interval on the flagpole such that N does not intersect any strand of T other than s and t , all windings on s and t lie in N , and the windings on s lie above those on t .)

Notice that $i(s) < i(t)$, since s precedes t in the standard orientation. Also $f(t) < f(s)$, since otherwise, by property (3) of \mathcal{O} , s would also precede t in the orientation \mathcal{O} . Thus we have $i(s) < i(t) < f(t) < f(s)$. The situation is illustrated in Figure 2.11.

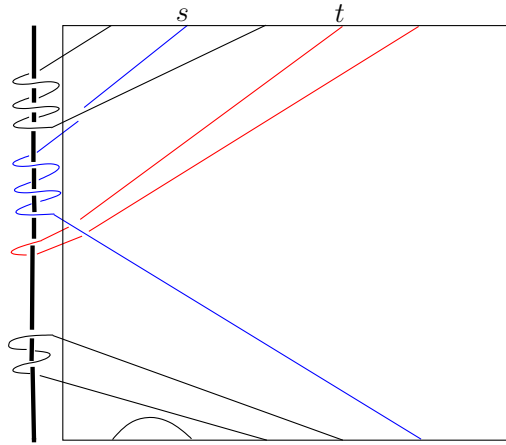

FIGURE 2.11. Flagpole descending affine tangle diagram

One can change crossings on T at will, because the result of changing crossings is congruent to T modulo the span of affine tangle diagrams with fewer than ℓ crossings; affine tangle diagrams with fewer than ℓ crossings are in the span the set of elements of \mathcal{S}' with fewer than ℓ crossings, and these in turn are in the span of \mathcal{S} by the induction hypothesis.

Note that s and t have exactly two crossings. Changing these crossings if necessary, one can slide the last winding on s below all the windings on t . One can check easily that this procedure does not change the number of crossings of s with t or with any other strand. Repeating this procedure several times if necessary, one can slide all windings on s below the windings on t , as illustrated in Figure 2.12. Finally, change the crossings of s and t if necessary to agree with the stratification order. The result, say T' , is congruent to T modulo the span of diagrams with fewer crossings, hence modulo the span of \mathcal{S} .

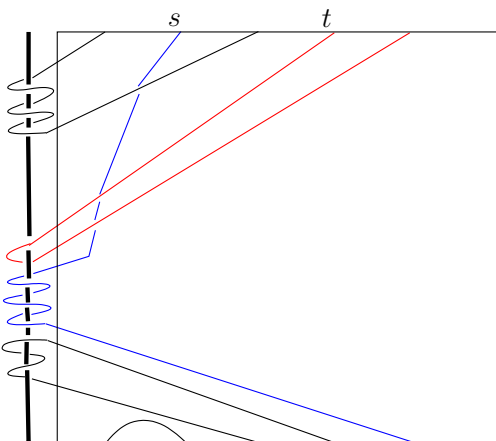

FIGURE 2.12. Tangle diagram—after several slides

If T' is not flagpole descending with respect to the orientation \mathcal{O} , the procedure described in the previous paragraphs can be repeated until a flagpole descending affine tangle diagram is obtained. \square

We recall that a Brauer diagram is a tangle diagram in the plane, in which information about over- and under-crossings is ignored:

Definition 2.20. An (n, n) -Brauer diagram (or n -connector) consists of a collection of n curves in the rectangle $R = I \times I$ such that

- (1) The curves connect the points $\{1, \dots, n, \bar{1}, \dots, \bar{n}\}$ in pairs.
- (2) For each curve C in the collection, the intersection of C with $\partial(R)$ consists of the two endpoints of C .

Let G be a group. A G -Brauer diagram (or G -connector) is a Brauer diagram in which each curve (strand) is endowed with an orientation and labeled by an element of the group G . Two labelings are regarded as the same if the orientation of a strand is reversed and the group element associated to the strand is inverted.

We will be interested only in \mathbb{Z} -Brauer diagrams. Define a map c (the connector map) from oriented affine (n, n) -tangle diagrams *without closed loops* to \mathbb{Z} -Brauer diagrams as follows. Let a be an oriented affine (n, n) -tangle diagram without closed loops. If s connects two vertices v_1 to v_2 , include a curve $c(s)$ in $c(a)$

connecting the same vertices with the same orientation, and label the oriented strand $c(s)$ with the *winding number* of s with respect to the flagpole.²

Lemma 2.21. *Endow affine (n, n) -tangles diagrams with an orientation and a stratification order, each determined by some rule depending on the vertices of the strands. Two affine tangle diagrams without closed loops, with the same \mathbb{Z} -Brauer diagram, both stratified according to the given stratification order and flagpole descending with respect to the given orientation, are ambient isotopic.*

Proof. A flagpole descending affine tangle diagram without closed loops is ambient isotopic to a tight circular form, and the tight circular form is uniquely determined by the \mathbb{Z} -Brauer diagram of the affine tangle diagram, the orientation, and the stratification order. \square

2.4. A new basis of the affine BMW algebra. For $1 \leq j \leq n$, define the affine tangle diagrams X_j and X'_j by

$$X_j = G_{j-1} \cdots G_1 X_1 G_1 \cdots G_{j-1}$$

and

$$X'_j = G_{j-1} \cdots G_1 X_1 G_1^{-1} \cdots G_{j-1}^{-1}.$$

See Figure 2.13. Also define $Y'_j = \rho X'_j = G_{j-1} \cdots G_1 Y_1 G_1^{-1} \cdots G_{j-1}^{-1}$.

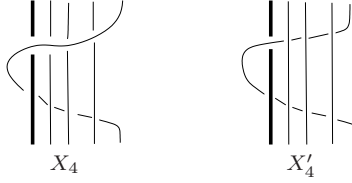

FIGURE 2.13. The elements X_i and X'_i

In this section we will consider affine and ordinary tangle diagrams without closed loops endowed with the hybrid orientation (see the definition just before Proposition 2.19) and the hybrid stratification order, which we now define:

²The winding number $n(s)$ is determined combinatorially as follows: traversing the strand in its orientation, list the over-crossings (+) and under-crossings (-) of the strand with the flagpole. Cancel any two successive +'s or -'s in the list, so the list now consists of alternating +'s and -'s. Then $n(s)$ is $\pm(1/2)$ the length of the list, + if the list begins with a +, and - if the list begins with a -.

Definition 2.22. A hybrid stratification order on the strands of an affine tangle diagram is one in which

- (1) Non-closed strands precede closed loops, and strands with an initial vertex at the top of the diagram precede those with both vertices at the bottom of the diagram.
- (2) Non-closed strands with initial vertex at the top of the diagram are ordered according to the order of the initial vertices.
- (3) Non-closed strands with initial vertex at the bottom of the diagram are ordered according to the reverse of the order of the final vertices.

Note that an affine tangle diagram without closed strands has a unique hybrid stratification order.

Let d be a \mathbb{Z} -Brauer diagram, and let d_0 be the ordinary Brauer diagram obtained by forgetting the integer valued labels of the strands. There is a unique (up to regular isotopy) stratified ordinary (n, n) -tangle diagram T_{d_0} with no closed loops or self-crossings of strands that has Brauer diagram d_0 . Define

$$T'_d = (X'_1)^{a_1} \cdots (X'_{n-1})^{a_{n-1}} T_{d_0} (X'_n)^{b_n} \cdots (X'_1)^{b_1},$$

where the exponents determined as follows: If d has a strand beginning at a top vertex i with label ℓ , then $b_i = \ell$; otherwise $b_i = 0$. If d has a strand beginning at a bottom vertex and ending at \bar{i} with label ℓ , then $a_i = \ell$; otherwise, $a_i = 0$.

Example 2.23. Figure 2.14 shows a \mathbb{Z} -Brauer diagram d and its lifting T'_d ; in the picture for T'_d , the winding numbers of strands are indicated by the integers written at the left. We have $T'_d = (X'_2)^3 (X'_3)^7 X'_4 T_{d_0}$.

Lemma 2.24. T'_d is stratified with respect to the hybrid stratification order and flagpole descending with respect to the hybrid orientation, and has \mathbb{Z} -Brauer diagram equal to d .

Proof. Straightforward. □

Theorem 2.25. $\mathbb{B}' = \{T'_d : d \text{ is a } \mathbb{Z}\text{-Brauer diagram}\}$ is a basis of $\widehat{KT}_{n,S}$.

Proof. Let $\rho, q, \delta_0, \delta_1, \delta_2, \dots$ be indeterminants over \mathbb{Z} . Let

$$\widehat{\Lambda} = \mathbb{Z}[\rho^{\pm 1}, q^{\pm 1}, \delta_0^{\pm 1}, \delta_1, \delta_2, \dots] / \langle \rho^{-1} - \rho = (q^{-1}q)(\delta_0 - 1) \rangle.$$

We showed in [10], Corollary 6.14, that for any commutative unital ring S containing elements ρ, q , and $\delta_j, j \geq 0$, with ρ, q , and δ_0 invertible, satisfying the

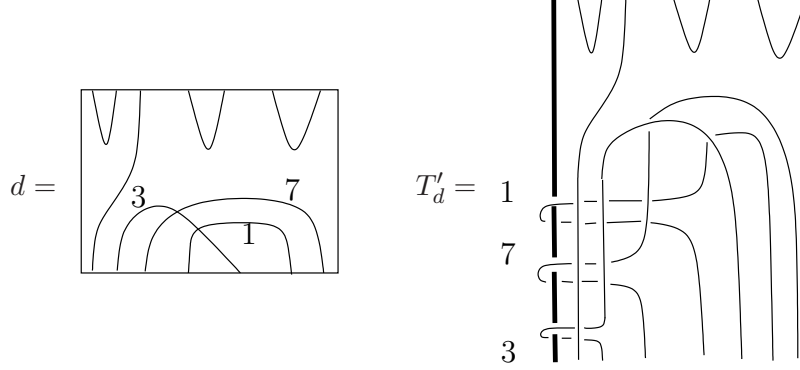
FIGURE 2.14. A \mathbb{Z} -Brauer diagram d and its lifting T'_d .

relation $\rho^{-1} - \rho = (q^{-1} - q)(\delta_0 - 1)$, we have $\widehat{KT}_{n,S} \cong \widehat{KT}_{n,\widehat{\Lambda}} \otimes_{\widehat{\Lambda}} S$. (Cf. Remark 3.3 below.) Therefore, it suffices to prove the result for $\widehat{KT}_{n,\widehat{\Lambda}}$.

It follows from Proposition 2.19, Lemma 2.21, and Lemma 2.24 that \mathbb{B}' spans $\widehat{KT}_{n,\widehat{\Lambda}}$. On the other hand, we showed in [10], Proposition 4.7, that any collection of affine tangle diagrams without closed loops having distinct \mathbb{Z} -Brauer diagrams is linearly independent over $\widehat{\Lambda}$. \square

In $\widehat{W}_{n,S}$, define for $1 \leq j \leq n$

$$y_j = g_{j-1} \cdots g_1 y_1 g_1 \cdots g_{j-1}$$

and

$$y'_j = g_{j-1} \cdots g_1 y_1 g_1^{-1} \cdots g_{j-1}^{-1}.$$

For each ordinary n -Brauer diagram d_0 , let T_{d_0} be the unique (up to regular isotopy) stratified ordinary (n, n) -tangle diagram with no closed loops or self-crossings of strands, and with Brauer diagram d_0 . We let \mathbb{A}' denote the collection of elements

$$(y'_1)^{a_1} \cdots (y'_{n-1})^{a_{n-1}} \varphi^{-1}(T_{d_0}) (y'_n)^{b_n} \cdots (y'_1)^{b_1},$$

where b_i is zero unless d_0 has a strand beginning at the top vertex \mathbf{i} and a_i is zero unless d_0 has a strand beginning at a bottom vertex and ending at the bottom vertex $\bar{\mathbf{i}}$, and $\varphi : \widehat{W}_{n,S} \rightarrow \widehat{KT}_{n,S}$ is the isomorphism of Theorem 2.5. \mathbb{A}' is essentially $\varphi^{-1}(\mathbb{B}')$, with each element normalized by some power of ρ .

Corollary 2.26. \mathbb{A}' is a basis of $\widehat{W}_{n,S}$.

3. THE CYCLOTOMIC BMW AND KAUFFMAN TANGLE ALGEBRAS

3.1. Definition of the cyclotomic BMW algebras. A cyclotomic Birman-Wenzl-Murakami algebra is a quotient of the affine BMW algebra in which the affine generator y_1 satisfies a monic polynomial equation.

Definition 3.1. Let S be a commutative unital ring with parameters ρ, q, δ_j ($j \geq 0$), and u_1, \dots, u_r , with ρ, q, δ_0 , and u_1, \dots, u_r invertible, and with $\rho^{-1} - \rho = (q^{-1} - q)(\delta_0 - 1)$. The *cyclotomic BMW algebra* $W_{n,S,r}(u_1, \dots, u_r)$ is the quotient of $\widehat{W}_{n,S}$ by the relation

$$(3.1) \quad (y_1 - u_1)(y_1 - u_2) \cdots (y_1 - u_r) = 0.$$

Remark 3.2. The assignment $e_i \mapsto e_i, g_i \mapsto g_i, y_1 \mapsto y_1$ defines a homomorphism ι from $W_{n,S,r}$ to $W_{n+1,S,r}$, since the relations are preserved. It is not evident that ι is injective. However, when S is an admissible integral domain (see Section 5), we can show that $W_{n,S,r}$ is isomorphic to the cyclotomic Kauffman tangle algebra $KT_{n,S,r}$ (defined below), and in this case, it is true that ι is injective.

Remark 3.3. Let S be a ring with parameters ρ, q , etc., as above, and let S' be another ring with parameters ρ', q' , etc. Suppose there is a ring homomorphism $\psi : S \rightarrow S'$ mapping $\rho \mapsto \rho', q \mapsto q'$, etc. Then $W_{n,S',r}$ can be regarded as an algebra over S , with $sx = \psi(s)x$ for $s \in S$ and $x \in W_{n,S',r}$, and there is an S -algebra homomorphism $\tilde{\psi} : W_{n,S,r} \rightarrow W_{n,S',r}$ taking generators to generators. We claim that $W_{n,S,r} \otimes_S S' \cong W_{n,S',r}$ as S' -algebras. In fact, we have the S' algebra homomorphism $\tilde{\psi} \otimes \text{id} : W_{n,S,r} \otimes_S S' \rightarrow W_{n,S',r} \otimes_S S' \cong W_{n,S',r}$. In the other direction, we have an S' -algebra homomorphism $\theta : W_{n,S',r} \rightarrow W_{n,S,r} \otimes_S S'$ mapping $g_i \mapsto g_i \otimes 1$, etc. The maps $\tilde{\psi} \otimes \text{id}$ and θ are inverses.

Of course, this remark applies in general to algebras defined by generators and relations.³

3.2. Definition of the cyclotomic Kauffman tangle algebras. Now we consider how to define a cyclotomic version of the Kauffman tangle algebra. Rewrite the relation (3.1) in the form

$$\sum_{k=0}^r (-1)^{r-k} \varepsilon_{r-k}(u_1, \dots, u_r) y_1^k = 0,$$

³ We could have slightly simplified some arguments in [10] using this remark.

where ε_j is the j -th elementary symmetric function. The corresponding relation in the affine Kauffman tangle algebra is

$$(3.2) \quad \sum_{k=0}^r (-1)^{r-k} \varepsilon_{r-k}(u_1, \dots, u_r) \rho^k X_1^k = 0,$$

Now we want to impose this as a local skein relation.

Definition 3.4. Let S be a commutative unital ring with parameters ρ , q , δ_j ($j \geq 0$), and u_1, \dots, u_r , with ρ , q , δ_0 , and u_1, \dots, u_r invertible, and with $\rho^{-1} - \rho = (q^{-1} - q)(\delta_0 - 1)$. The *cyclotomic Kauffman tangle algebra* $KT_{n,S,r}(u_1, \dots, u_r)$ is the quotient of the affine Kauffman tangle algebra $\widehat{KT}_{n,S}$ by the cyclotomic skein relation:

$$(3.3) \quad \sum_{k=0}^r (-1)^{r-k} \varepsilon_{r-k}(u_1, \dots, u_r) \rho^k \left(\text{circle with } X_1^k \text{ inside} \right) = 0,$$

The sum is over affine tangle diagrams that are identical outside of the disc; the interior of the disc contains an interval on the flagpole and a piece of an affine tangle diagram isotopic to X_1^k .

We continue to write E_i , G_i , X_1 for the image of these elements of the affine Kauffman tangle algebra in the cyclotomic Kauffman tangle algebra. We write

$$Y_1 = \rho X_1.$$

The ideal in the affine Kauffman tangle algebra by which we are taking the quotient contains the ideal generated by

$$(Y_1 - u_1)(Y_1 - u_2) \cdots (Y_1 - u_r),$$

but could in principal be larger. It follows that there is a homomorphism $\varphi : W_{n,S,r}(u_1, \dots, u_r) \rightarrow KT_{n,S,r}(u_1, \dots, u_r)$ determined by $y_1 \mapsto Y_1$, $e_i \mapsto E_i$, $g_i \mapsto G_i$. Moreover, the following diagram (in which the vertical arrows are the quotient maps) commutes.

$$\begin{array}{ccc} \widehat{W}_{n,S} & \xrightarrow{\varphi} & \widehat{KT}_{n,S} \\ \pi \downarrow & & \downarrow \pi \\ W_{n,S,r}(u_1, \dots, u_r) & \xrightarrow{\varphi} & KT_{n,S,r}(u_1, \dots, u_r) \end{array}$$

The homomorphism $\varphi : W_{n,S,r}(u_1, \dots, u_r) \rightarrow KT_{n,S,r}(u_1, \dots, u_r)$ is surjective because the diagram commutes and $\varphi : \widehat{W}_{n,S} \rightarrow \widehat{KT}_{n,S}$ is an isomorphism.

3.3. Inclusions and conditional expectations for cyclotomic Kauffman tangle algebras. Let S be a ring with parameters as above and write $KT_{n,S,r}$ for $KT_{n,S,r}(u_1, \dots, u_r)$. The affine Kauffman tangle algebras have inclusion maps $\iota : \widehat{KT}_{n-1,S} \rightarrow \widehat{KT}_{n,S}$, defined on the level of affine tangle diagrams by adding an additional strand on the right without adding any crossings:

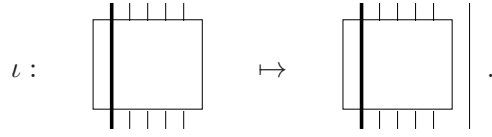

Since these maps respect the cyclotomic relation (3.3), they induce homomorphisms

$$\iota : KT_{n-1,S,r} \rightarrow KT_{n,S,r}.$$

Recall also that the affine Kauffman tangle algebras have a conditional expectation $\varepsilon_n : \widehat{KT}_n \rightarrow \widehat{KT}_{n-1}$ defined by

$$\varepsilon_n(T) = \delta_0^{-1} \text{cl}_n(T),$$

where cl_n is the map of affine (n, n) -tangle diagrams to affine $(n-1, n-1)$ -tangle diagrams that “closes” the rightmost strand, without adding any crossings:

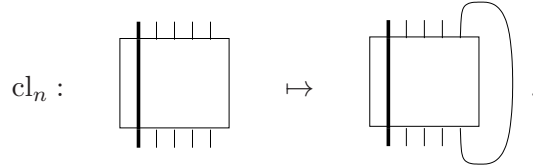

These maps respect the cyclotomic relation (3.3), so induce conditional expectations

$$\varepsilon_n : KT_{n,S,r} \rightarrow KT_{n-1,S,r}$$

Since $\varepsilon_n \circ \iota$ is the identity on $KT_{n-1,S,r}$, it follows that $\iota : KT_{n-1,S,r} \rightarrow KT_{n,S,r}$ is injective.

Remark 3.5. Let S be a ring with parameters ρ, q , etc., as above, and let S' be another ring with parameters ρ', q' , etc. Suppose there is a ring homomorphism $\psi : S \rightarrow S'$ mapping $\rho \mapsto \rho', q \mapsto q'$, etc. Any S' -algebra can be regarded as an S -algebra using ψ . We have a map of monoid rings $\tilde{\psi} : S \widehat{U}(n, n) \rightarrow S' \widehat{U}(n, n)$, and this map respects regular isotopy, the Kauffman skein relations, and the

cyclotomic relations, so induces an S -algebra homomorphism from $\tilde{\psi} : KT_{n,S,r} \rightarrow KT_{n,S',r}$. As in Remark 3.3, we have $KT_{n,S,r} \otimes_S S' \cong KT_{n,S',r}$ as S' -algebras.

3.4. Finite spanning sets. Recall the basis \mathbb{A}' of the affine BMW algebra $\widehat{W}_{n,S}$ described at the end of Section 2. Let \mathbb{A}'_r be the set of

$$(y'_1)^{a_1} \cdots (y'_{n-1})^{a_{n-1}} \varphi^{-1}(T_{d_0})(y'_n)^{b_n} \cdots (y'_1)^{b_1} \in \mathbb{A}'$$

such that $0 \leq a_i, b_i \leq r-1$ for all i . The cardinality of \mathbb{A}'_r is $r^n(2n-1)!!$.

Proposition 3.6. *For any ring S with parameters ρ, q, δ_j ($j \geq 0$), and u_1, \dots, u_r , as above, the cyclotomic BMW algebra $W_{n,S,r}(u_1, \dots, u_r)$ is spanned over S by \mathbb{A}'_r .*

Proof. Since \mathbb{A}' is a basis of the affine BMW algebra $\widehat{W}_{n,S}$, the image of \mathbb{A}' in $W_{n,S,r}(u_1, \dots, u_r)$ is spanning. But in the cyclotomic BMW algebra, each y'_j is conjugate to y_1 , so satisfies a polynomial equation of degree r . Therefore the span of \mathbb{A}'_r equals the span of \mathbb{A}' . \square

Let \mathbb{B}'_r be the image of \mathbb{A}'_r in the cyclotomic Kauffman tangle algebra, namely \mathbb{B}'_r is the set of

$$(Y'_1)^{a_1} \cdots (Y'_{n-1})^{a_{n-1}} T_{d_0} (Y'_n)^{b_n} \cdots (Y'_1)^{b_1} \in \mathbb{B}'$$

such that $0 \leq a_i, b_i \leq r-1$ for all i .

We have:

Corollary 3.7. *For any ring S with parameters ρ, q, δ_j ($j \geq 0$), and u_1, \dots, u_r , as above, the cyclotomic Kauffman tangle algebra $KT_{n,S,r}(u_1, \dots, u_r)$ is spanned over S by \mathbb{B}'_r .*

Proof. $\varphi : W_{n,S,r} \rightarrow KT_{n,S,r}$ is surjective. \square

4. WEAK ADMISSIBILITY AND THE MARKOV TRACE

4.1. Definition of weak admissibility. The cyclotomic BMW algebras and Kauffman tangle algebras can be defined over an arbitrary commutative unital ring S with parameters ρ, q, δ_j ($j \geq 0$), and u_1, \dots, u_r , such that ρ, q, δ_0 and u_1, \dots, u_r are invertible, and $\rho^{-1} - \rho = (q^{-1} - q)(\delta_0 - 1)$. However, unless the parameters satisfy additional relations, the identity element $\mathbf{1}$ of the cyclotomic Kauffman tangle algebras will be a torsion element over S ; if S is a field (and the additional relations do not hold) then $\mathbf{1} = 0$, so $KT_{n,S,r} = \{0\}$.

Define $\delta_{-j} \in S$ for $j \geq 1$ by

$$\rho^{-j}\Theta_{-j} = \delta_{-j} \mathbf{1}.$$

(This is an equation in the affine Kauffman tangle algebra $\widehat{KT}_{0,S}$). The elements δ_{-j} can be expressed as polynomials in $\delta_0, \dots, \delta_j$ with coefficients in $\mathbb{Z}[\rho^{\pm 1}, q - q^{-1}]$. In fact, from Lemma 2.6, we have the recursive relations:

$$(4.1) \quad \begin{aligned} \delta_{-1} &= \rho^{-2}\delta_1 \\ \delta_{-j} &= \rho^{-2}\delta_j - (q^{-1} - q)\rho^{-1} \sum_{k=1}^{j-1} (\delta_k \delta_{k-j} - \delta_{2k-j}). \end{aligned}$$

Now pass to the cyclotomic algebra $KT_{0,S,r}$. By the cyclotomic skein relation (3.3), we have for any integer a ,

$$\sum_{k=0}^r (-1)^{r-k} \varepsilon_{r-k}(u_1, \dots, u_r) \rho^k \Theta_{k+a} = 0,$$

This gives the relations

$$\left(\sum_{k=0}^r (-1)^{r-k} \varepsilon_{r-k}(u_1, \dots, u_r) \delta_{k+a} \right) \mathbf{1} = 0,$$

for each $a \in \mathbb{Z}$. It follows that either the identity $\mathbf{1}$ of the cyclotomic Kauffman tangle algebra $KT_{0,S,r}$ is a torsion element over S , or for all $a \in \mathbb{Z}$, we have

$$(4.2) \quad \sum_{k=0}^r (-1)^{r-k} \varepsilon_{r-k}(u_1, \dots, u_r) \delta_{k+a} = 0,$$

A similar computation done in the cyclotomic BMW algebra $W_{2,S,r}$ shows that e_1 is a torsion element unless the relations (4.2) hold.

Definition 4.1. Let S be a commutative unital ring containing elements ρ , q , δ_j , $j \geq 0$, and u_1, \dots, u_r , with ρ , q , δ_0 , and u_1, \dots, u_r invertible. We say that the parameters are *weakly admissible* (or that the ring S is weakly admissible) if the following relations hold:

$$\rho^{-1} - \rho = (q^{-1} - q)(\delta_0 - 1).$$

and

$$\sum_{k=0}^r (-1)^{r-k} \varepsilon_{r-k}(u_1, \dots, u_r) \delta_{k+a} = 0,$$

for $a \in \mathbb{Z}$, where for $j \geq 1$, δ_{-j} is defined by the recursive relations of Equation (4.1).

4.2. $KT_{0,S,r}$ is a free S -module. In this section we will show that weak admissibility of S implies that $KT_{0,S,r}(u_1, \dots, u_r)$ is a free S -module. A consequence of this is the existence of a special trace (the Markov trace) on the cyclotomic Kauffman tangle algebras $KT_{n,S,r}$ and the cyclotomic BMW algebras $W_{n,S,r}$, when S is weakly admissible.

To show that $KT_{0,S,r}$ is a free S -module, we have to show that the quotient map $\pi : \widehat{KT}_{0,S} \rightarrow KT_{0,S,r}(u_1, \dots, u_r)$ is injective. We start with some observations about the kernel of $\pi : \widehat{KT}_{n,S} \rightarrow KT_{n,S,r}(u_1, \dots, u_r)$ for any n . The kernel of π is the span of elements T of the form

$$T = \sum_{k=1}^r (-1)^{r-k} \varepsilon_{r-k}(u_1, \dots, u_r) \rho^k T_k,$$

where T_0, T_1, \dots, T_r are affine (n, n) -tangle diagrams that are identical in the exterior of some disc E , and the interior of the disc E in T_k contains an interval on the flagpole and a piece of an affine tangle diagram isotopic to X_1^k . We refer to such a sum as *generator* of the ideal $\ker \pi$. We can speak of the number of crossings of a generator T , which is the number of crossings of ordinary strands of each T_k .

We say that T is in standard position if each of its summands T_k is in standard position. The reduction by regular isotopy of an affine tangle diagram to one in standard position can be done simultaneously for the summands T_k of a generator T , without disturbing the interior of the disc E . Therefore we can always assume that a generator is in standard position.

Note if we apply any of the skein relations of Definition 2.1 to each summand T_k of a generator T , then we stay in the ideal $\ker \pi$. For example, we have

$$T = T' + (q^{-1} - q)(T^{(0)} - T^{(\infty)}),$$

where T' is the generator obtained by changing a certain crossing (exterior to E) in each T_k , while $T^{(0)}$ is the generator obtained from the horizontal smoothing of the same crossing in each T_k , and $T^{(\infty)}$ is the generator obtained from the vertical smoothing of the crossing in each T_k . Thus, $T \equiv T'$ modulo the span of generators of $\ker \pi$ with strictly fewer crossings.

Lemma 4.2. *An affine $(0, 0)$ -tangle diagram in standard position, with no crossings of ordinary strands, is equal in $\widehat{KT}_{0,S}$ to a monomial in $\rho^{\pm 1}$ and $\{\delta_j : j \in \mathbb{Z}\}$.*

Proof. Let T be such an affine tangle diagram. Each closed strand comprising T , taken by itself, must be flagpole-descending since it has no self-crossings.

However, the entire affine tangle diagram is not necessarily flagpole–descending because simple windings on one closed strand can intervene between two simple windings on another closed strand as in the following figure:



Let $A = \{p_1, \dots, p_{2k}\}$ be the set of points at which the strands of T cross the flagpole, read from top to bottom. Let A_s be the set of points of A on strand s . Then $\{A_s : s \text{ is a closed strand}\}$ is a *non-crossing partition* of A , see [20]. That is, it is not possible to have $p_i, p_j \in A_s$ and $p_k, p_l \in A_t$ ($s \neq t$) with $i < k < j < l$. It follows that some A_s is an interval in A ; that is, there are no $p_i, p_j \in A_s$ and $p_k \in A_t$ ($s \neq t$) with $i < k < j$. But then, the strand s is regularly isotopic with some Θ_j ($j \in \mathbb{Z}$) and by the free loop relations in Definition 2.1, $T = \rho^{-j} \delta_j T'$, where T' is obtained by erasing the strand s from T . The result now follows by induction on the number of strands of T . \square

Proposition 4.3. *Let S be an weakly admissible ring with parameters ρ , q , δ_j ($j \geq 0$) and u_1, \dots, u_r . Then $KT_{0,S,r}(u_1, \dots, u_r)$ is a free S module of rank 1.*

Proof. We have to show that the quotient map $\pi : \widehat{KT}_{0,S} \rightarrow KT_{0,S,r}(u_1, \dots, u_r)$ is injective. Let $T = \sum_{k=1}^r (-1)^{r-k} \varepsilon_{r-k}(u_1, \dots, u_r) \rho^k T_k$ be a generator of the ideal $\ker \pi$, where we assume that each T_k is in standard position.

If T has no crossings of ordinary strands, then by the previous lemma, there is a monomial m in $\rho^{\pm 1}$ and $\{\delta_j : j \in \mathbb{Z}\}$, and an $a \in \mathbb{Z}$, such that for each k , $\rho^k T_k = \delta_{k+a} m$. Thus $T = m \sum_{k=1}^r (-1)^{r-k} \varepsilon_{r-k}(u_1, \dots, u_r) \delta_{k+a}$. But this is zero, by the weak admissibility of S .

We now suppose that T has $\ell \geq 1$ crossings of ordinary strands, and that any generator T' of the ideal $\ker \pi$ with fewer than ℓ crossings is equal to zero. By this induction assumption and by the remarks preceding Lemma 4.2, changing a crossing in T (that is, changing the same crossing in each T_k) does not change T (as an element of $\widehat{KT}_{0,S}$). So we can assume that each T_k is stratified, in circular form with respect to a circle D , and tight — see the discussion following Remark 2.15.

We will apply a version of the “straightening algorithm” of Proposition 2.18 to each T_k simultaneously, without changing anything in the interior of the disc E .

Let s_0 be the unique strand in T_k with non-trivial intersection with the disc E . Suppose s is a strand in T_k other than s_0 . If s has no windings with the flagpole, then s can be translated away from the other strands, and then removed, using the free loop relation. (We have $T = \delta_0 T'$, where T' is the generator of $\ker \pi$ in which the strand s has been removed from each T_k .)

So we suppose that s does have windings with the flagpole, and we let p_1 denote the highest winding point on $D \cap s$ and p_2 the second winding point on the same simple winding as p_1 . Orient s so that p_1 is the initial point and the simple winding containing p_1 and p_2 is traversed from p_1 to p_2 . Let p_1, p_2, \dots, p_{2t} be the list of winding points, on s and on other strands, that are below p_1 on D , listed according to their position on D , in counterclockwise order. Let $w_1 = p_1, w_2 = p_2, \dots, w_{2m}$ be the set of winding points on s , listed in the order of the orientation of s . We have an injection of $f : \{1, 2, \dots, 2m\} \rightarrow \{1, 2, \dots, 2t\}$ such that $w_j = p_{f(j)}$. Define the *length* of f to be the number of j such that $f(j) > j$; in fact, the length depends only on the choice of s , and is the same for all T_k , so we denote it by $\ell(s, T)$.

If $\ell(s, T) = 0$, then $f(j) = j$ for all j , and s , taken by itself, is flagpole descending. Moreover, its winding points occupy an interval among all winding points on D , so T_k is ambient isotopic to an affine tangle diagram in which s is replaced by a copy of $\Theta_{\pm m}$ having no crossings with other strands. Then the strand s can be removed, using the free loop relation.

Suppose now that $\ell(s, T) > 0$. Let j_0 be the first index such that $f(j_0) > j_0$. We suppose that the simple winding with winding points w_{j_0} and w_{j_0+1} is of type (c) from Figure 2.5; the other types can be handled similarly.

Now we will proceed as in the proof of Case 2 in Proposition 2.18. Let W_1 be the set of winding points $w_i (= p_i)$ with $i < j_0$. Let W_2 be the set of winding points p_j located between W_1 and w_{j_0} on D . Let W_3 be the set of winding points p_j located below (counterclockwise from) w_{j_0+1} . Then w_{j_0} is connected by a D -arc α to the last winding point in W_1 . All D -arcs that cross α are incident with W_2 . Figure 2.9 illustrates the situation. Now exactly as in the proof of Case 2 in Proposition 2.18, we can slide the simple winding containing the winding points w_{j_0} and w_{j_0+1} to a position between W_1 and W_2 . In our situation, we don't have to be concerned with any crossing changes required to do this. We note that this

move does not increase the number of crossings of T_k , and does not disturb the interior of the disc E ; the move does decrease the length $\ell(s, T)$. By repeating this move, we can eventually reduce the length to zero, and then the strand s can be removed by the free loop relation, as explained above.

We repeat this procedure with other strands until only the strand s_0 having non-trivial intersection with the disc E is left. We now have $T = mT'$, where m is a monomial in $\rho^{\pm 1}$ and $\{\delta_j : j \in \mathbb{Z}\}$, and T' is the generator of $\ker \pi$ obtained by erasing all strands other than s_0 from all the T_k .

We need only a slight variation of the procedure used so far in order to deal with s_0 . Let W_0 be the set of winding points on D corresponding to simple windings in the disc E . Let p_1, p_2, \dots, p_{2u} be the winding points below W_0 on D , listed according to their position on D , in counterclockwise order. Let q_1, q_2, \dots, q_{2t} be the winding points above W_0 on D , listed according to their position on D , in counterclockwise order. Orient s_0 so that the simple windings in the disc E descend the flagpole. Let w_1, \dots, w_{2u+2t} be the winding points on s_0 outside of E , listed according to the orientation of s_0 . Define the length of T' , denoted $\ell(T')$, to be $2t$ plus the number of j such that $w_j = p_i$ for some i , but $j \neq i$. If $\ell(T') = 0$, then T'_k is flagpole descending and ambient isotopic to some Θ_{k+a} ; it follows that T' is a multiple of $\sum_{k=1}^r (-1)^{r-k} \varepsilon_{r-k}(u_1, \dots, u_r) \delta_{k+a}$, which is zero, by the weak admissibility of S .

We suppose that $\ell(T') > 0$ and that whenever T'' is a generator of $\ker \pi$ such that each T''_k has only one closed strand, and $\ell(T'') < \ell(T')$, then $T'' = 0$. Let j_0 be the first index such that $w_{j_0} = p_i$ for some i with $i \neq j_0$ or $w_{j_0} = q_i$ for some i . If $w_{j_0} = p_i$ for some i with $i \neq j_0$, then, as in previously considered cases, the length of T' can be reduced by sliding a simple winding; it follows from the induction hypothesis that $T' = 0$.

Suppose that $w_{j_0} = q_i$ for some i . By pulling the arc from w_{j_0-1} to w_{j_0} around the flagpole, we can transfer the simple winding associated with the winding point w_{j_0} from its position above the disc E to a new position below w_{j_0-1} . Suppose, for example, that the simple winding associated with the winding point w_{j_0} is of type (d) from Figure 2.5; then the procedure is illustrated in Figure 4.1. Again, we do not have to be concerned with any crossing changes required to perform this move. The move reduces the length of T' , so it follows from the induction hypothesis that $T' = 0$. \square

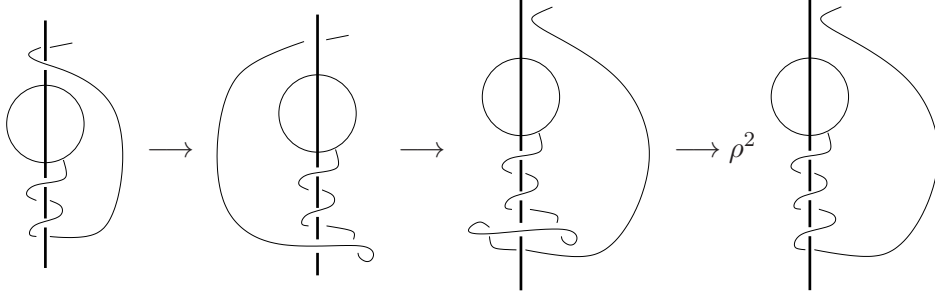

FIGURE 4.1. A wrapping move

4.3. The Markov trace. We can now identify $KT_{0,S,r}$ with S , when S is weakly admissible. Recall we have conditional expectations $\varepsilon_n : KT_{n,S,r} \rightarrow KT_{n-1,S,r}$ for $n \geq 1$. It follows from [10], Proposition 2.14, that the composition

$$\varepsilon = \varepsilon_1 \circ \cdots \circ \varepsilon_n : KT_{n,S,r} \rightarrow KT_{0,S,r} \cong S$$

is a trace. We also define $\varepsilon : W_{n,S,r} \rightarrow S$ by $\varepsilon = \varepsilon \circ \varphi$, where $\varphi : W_{n,S,r} \rightarrow KT_{n,S,r}$ is the canonical homomorphism. Then ε is a trace on $W_{n,S,r}$ with the *Markov property*: for $b \in W_{n-1,S,r}$,

- (a) $\varepsilon(bg_{n-1}^{\pm 1}) = (\rho^{\pm 1}/\delta_0)\varepsilon(b)$,
- (b) $\varepsilon(be_{n-1}) = (1/\delta_0)\varepsilon(b)$,
- (c) $\varepsilon(b(y'_n)^r) = \delta_r\varepsilon(b)$, and

for $r \in \mathbb{Z}$, where $y'_n = (g_{n-1} \cdots g_1)y_1(g_1^{-1} \cdots g_{n-1}^{-1})$. See [10], Corollary 6.16.

Lemma 4.4. *Let S be a weakly admissible ring. Then for all $n \geq 1$, E_n and G_n are non-zero elements in $KT_{n,S,r}$.*

Proof. $\varepsilon(E_n) = \delta_0^{-1}$ and $\varepsilon(G_n) = \rho^{-1}\delta_0^{-2}$. □

5. ADMISSIBILITY

To obtain any substantial results about the cyclotomic BMW algebras, it appears to be necessary to impose stronger conditions on the ground ring. An appropriate condition has been found by Wilcox and Yu [31].

Consider a commutative, unital ring S with parameters ρ, q, δ_j ($j \geq 0$) and u_1, \dots, u_r , with ρ, q, δ_0 , and u_i invertible, satisfying $\rho^{-1} - \rho - (q^{-1} - q)(\delta_0 - 1)$. Let a_j denote the signed elementary symmetric function in u_1, \dots, u_r ,

$$a_j = (-1)^{r-j} \varepsilon_{r-j}(u_1, \dots, u_r).$$

Let W_2 denote the cyclotomic BMW algebra $W_2 = W_{2,S,r}(u_1, \dots, u_r)$. Write e for e_1 and g for g_1 .

Lemma 5.1. *The left ideal W_2e in W_2 is equal to the S -span of $\{e, y_1e, \dots, y_1^{r-1}e\}$.*

Theorem 5.2 (Wilcox-Yu, [31]). *Let S be a commutative, unital ring with elements ρ, q, δ_j ($j \geq 0$) and u_1, \dots, u_r , with ρ, q, δ_0 , and u_i invertible, satisfying $\rho^{-1} - \rho = (q^{-1} - q)(\delta_0 - 1)$. Assume that $(q - q^{-1})$ is non-zero and not a zero-divisor in S . The following conditions are equivalent:*

- (1) *S is weakly admissible, and $\{e, y_1e, \dots, y_1^{r-1}e\}$ is linearly independent over S (in $W_2 = W_{2,S,r}(u_1, \dots, u_r)$).*
- (2) *The parameters satisfy the following relations:*

$$(5.1) \quad \rho(a_\ell - a_{r-\ell}/a_0) + (q - q^{-1}) \left[\sum_{j=1}^{r-\ell} a_{j+\ell} \delta_j - \sum_{j=\max(\ell+1, \lceil r/2 \rceil)}^{\lfloor (\ell+r)/2 \rfloor} a_{2j-\ell} + \sum_{j=\lceil \ell/2 \rceil}^{\min(\ell, \lceil r/2 \rceil - 1)} a_{2j-\ell} \right] = 0,$$

for $1 \leq \ell \leq r - 1$,

and

$$(5.2) \quad \rho^{-1}a_0 - \rho a_0^{-1} = \begin{cases} 0 & \text{if } r \text{ is odd} \\ (q - q^{-1}) & \text{if } r \text{ is even.} \end{cases}$$

- (3) *S is weakly admissible, and $W_2 = W_{2,S,r}(u_1, \dots, u_r)$ admits a module M with an S -basis $\{v_0, y_1v_0, \dots, y_1^{r-1}v_0\}$ such that $ev_0 = \delta_0v_0$.*

Definition 5.3 (Wilcox and Yu, [31]). Let S be a commutative, unital ring with elements ρ, q, δ_j ($j \geq 0$) and u_1, \dots, u_r , with ρ, q, δ_0 , and u_i invertible, satisfying $\rho^{-1} - \rho = (q^{-1} - q)(\delta_0 - 1)$. One says that S is *admissible* (or that the parameters are admissible) if $(q - q^{-1})$ is non-zero and not a zero divisor in S and if the equivalent conditions of Theorem 5.2 hold.

It is shown in [11] and in [32, 30] that there exists a universal admissible integral domain \overline{R} , with the property that every admissible integral domain is a quotient of \overline{R} . Denote the parameters of \overline{R} by ρ, q, δ_j ($j \geq 0$) and $\mathbf{u}_1, \dots, \mathbf{u}_r$. We show in [11] that $\mathbf{q}, \mathbf{u}_1, \dots, \mathbf{u}_r$ are algebraically independent over \mathbb{Z} and that the field of fractions F of \overline{R} is isomorphic to $\mathbb{Q}(\mathbf{q}, \mathbf{u}_1, \dots, \mathbf{u}_r)$.

The proof of the following theorem from [11] depends on the existence of the Markov trace on $KT_{n,F,r}$, shown in Section 4 of this paper, and is otherwise independent of this paper.

Theorem 5.4 ([11]). *Let F denote the field of fractions of the universal admissible integral domain \overline{R} . Write $W_{n,F,r}$ for $W_{n,F,r}(\mathbf{u}_1, \dots, \mathbf{u}_r)$, and $KT_{n,F,r}$ for $KT_{n,F,r}(\mathbf{u}_1, \dots, \mathbf{u}_r)$. For all $n \geq 0$, the following assertions hold:*

- (1) $\varphi : W_{n,F,r} \rightarrow KT_{n,F,r}$ is an isomorphism.
- (2) The Markov trace ε on $KT_{n,F,r}$ is non-degenerate.
- (3) $W_{n,F,r}$ is split semisimple of dimension $r^n(2n-1)!!$.

The following theorem has been obtained independently by Wilcox and Yu.

Theorem 5.5 (Goodman and Hauschild–Mosley, Wilcox and Yu [32, 30]). *Let S be an admissible integral domain. Then $W_{n,S,r} \cong KT_{n,S,r}$, and $W_{n,S,r}$ is a free S -module of rank $r^n(2n-1)!!$.*

Proof. For any S , the set \mathbb{A}'_r is a spanning set in $W_{n,S,r}$ of cardinality $r^n(2n-1)!!$ by Proposition 3.6. It suffices to show that $\varphi(\mathbb{A}'_r) = \mathbb{B}'_r$ is linearly independent in $KT_{n,S,r}$. When $S = F$, this follows from Theorem 5.4, since \mathbb{B}'_r is a spanning set whose cardinality equals the dimension of $KT_{n,F,r}$. The map $x \mapsto x \otimes 1$ from $KT_{n,\overline{R},r}$ to $KT_{n,\overline{R},r} \otimes_{\overline{R}} F \cong KT_{n,F,r}$ is \overline{R} -linear and maps \mathbb{B}'_r to a linearly independent set in $KT_{n,F,r}$; hence \mathbb{B}'_r is linearly independent in $KT_{n,\overline{R},r}$. Finally, since any admissible integral domain S is a quotient of \overline{R} , and $KT_{n,\overline{R},r}$ is a free \overline{R} -module with basis \mathbb{B}'_r , it follows that $KT_{n,S,r} \cong KT_{n,\overline{R},r} \otimes_{\overline{R}} S$ is a free S -module with basis \mathbb{B}'_r . \square

6. REMARKS ON THE AFFINE AND CYCLOTOMIC HECKE ALGEBRAS

In this section, we apply our techniques to the affine and cyclotomic Hecke algebras, rather than the affine and cyclotomic BMW algebras, recovering the main technical result (Theorem 5) of Lambropoulou [18]. This result was used in [18] to construct Markov traces on the Artin braid group of type B that factor through the affine Hecke algebra, and thus invariants of links in the solid torus.

First we want to explain that the Artin braid group of type B is isomorphic to the group of braids in the annulus cross the interval. Consequently, the affine Hecke algebra can be identified with the algebra of such braids, modulo Hecke skein relations. This is proved, for example, in [6] and [1], but we want to point out an elementary proof, using only facts from Section 1.4 of [4], and a short argument

- (2) $\beta_i \beta_{i+1} \beta_i = \beta_{i+1} \beta_i \beta_i$ for $1 \leq i \leq n-2$.
(3) $\beta_i \beta_j = \beta_j \beta_i$ if $|i-j| \geq 2$.

It is easy to check that $\beta_0 \mapsto \sigma_0^2$, and $\beta_i \mapsto \sigma_i$ for $1 \leq i \leq n-1$ defines a homomorphism $\varphi : \mathcal{A}(B_n) \rightarrow \widehat{\mathcal{B}}_n \subset \mathcal{B}_{n+1}$. We are going to show that this map is an isomorphism.

Proposition 6.2 ([6], [1]). *The Artin group $\mathcal{A}(B_n)$ is isomorphic to the affine braid group $\widehat{\mathcal{B}}_n$.*

Proof. For $0 \leq i < j \leq n$, let

$$A_{i,j} = \sigma_{j-1} \cdots \sigma_{i+1} \sigma_i^2 \sigma_{i+1}^{-1} \cdots \sigma_{j-1}^{-1}.$$

By computation, or by a picture proof, one verifies that

$$A_{i,j} = \sigma_i^{-1} \cdots \sigma_{j-2}^{-1} \sigma_{j-1}^2 \sigma_{j-2} \cdots \sigma_i.$$

The following is part of the statement of [4], Lemma 1.8.2.

Fact 1: The set of $A_{i,j}$ generates the pure braid group \mathcal{P}_{n+1} .

Let V_0 denote the subgroup of \mathcal{P}_{n+1} generated by the set of $A_{0,j}$ with $1 \leq j \leq n$. One can check that V_0 is normalized by σ_j for $j \geq 1$. In fact, we have

$$(6.1a) \quad \sigma_j A_{0,j} \sigma_j^{-1} = A_{0,j+1} \quad (1 \leq j \leq n-1)$$

$$(6.1b) \quad \sigma_k A_{0,j} \sigma_k^{-1} = A_{0,j} \quad (k \geq 1 \text{ and } k \notin \{j-1, j\}),$$

$$(6.1c) \quad \sigma_j A_{0,j+1} \sigma_j^{-1} = A_{0,j+1}^{-1} A_{0,j} A_{0,j+1} \quad (1 \leq j \leq n-1).$$

The first two relations are checked easily by picture proofs or by using the Artin presentation. The last relation can be proved by induction on j . The base case $j=1$ follows from the braid relations. Assume relation (6.1c) for a particular value of j and apply $\text{Ad}(\sigma_j \sigma_{j+1})$ to both sides of the equation; reducing using the braid relations as well as relations (6.1a) and (6.1b) yields (6.1c) with $j+1$ in place of j .

It follows from Fact 1 that V_0 is normal in \mathcal{P}_{n+1} , and $\mathcal{P}_{n+1} = \mathcal{P}_n V_0$. Moreover, V_0 is normalized by \mathcal{B}_n .

Now any element $b \in \mathcal{B}_{n+1}$ can be written as $b = \gamma b_0$, where b_0 is a pure braid and γ is a permutation braid, i.e. a braid in which any two strands cross at most once. Moreover, $\pi(b) = \pi(\gamma)$. If $b \in \widehat{\mathcal{B}}_n$, then $\gamma \in \mathcal{B}_n$. That is,

$$\widehat{\mathcal{B}}_n \subseteq \mathcal{B}_n \mathcal{P}_{n+1} = \mathcal{B}_n \mathcal{P}_n V_0 = \mathcal{B}_n V_0 \subseteq \widehat{\mathcal{B}}_n.$$

Thus we have

Fact 2: $\widehat{\mathcal{B}}_n = \mathcal{B}_n \times V_0$.

It follows that the homomorphism $\varphi : \mathcal{A}(B_n) \rightarrow \widehat{\mathcal{B}}_n$ is surjective.

The map $\sigma_i \mapsto \sigma_{n-1-i}^{-1}$ determines an automorphism of \mathcal{B}_{n+1} which takes

$$A_{0,j} = \sigma_0^{-1} \cdots \sigma_{j-2}^{-1} \sigma_{j-1}^2 \sigma_{j-2} \cdots \sigma_0$$

to

$$\sigma_{n-1} \cdots \sigma_{n-j+1} \sigma_{n-j}^{-2} \sigma_{n-j+1}^{-1} \cdots \sigma_{n-1}^{-1} = A_{n-j,n}^{-1}.$$

The image of V_0 is the group U_n generated by $\{A_{k,n} : 0 \leq k \leq n-1\}$. By [4], page 23, U_n is a free group with free basis $\{A_{k,n} : 0 \leq k \leq n-1\}$. Hence,

Fact 3: V_0 is a free group with free basis $\{A_{0,j} : 1 \leq j \leq n\}$.

Now we can attempt to define a homomorphism $\psi : \widehat{\mathcal{B}}_n \rightarrow \mathcal{A}(B_n)$ via the requirements $\psi(\sigma_i) = \beta_i$ for $1 \leq i \leq n-1$ and

$$\psi(A_{0,j}) = t_j := \beta_{j-1} \cdots \beta_1 \beta_0 \beta_1^{-1} \cdots \beta_{j-1}^{-1}.$$

Because the β_i for $i \geq 1$ satisfy the ordinary braid relations, and since the set of $A_{0,j}$ are free generators of V_0 , these requirements define homomorphisms on \mathcal{B}_n and on V_0 . To check that ψ extends to a homomorphism on $\widehat{\mathcal{B}}_n = \mathcal{B}_n \times V_0$, it suffices to check that $\beta_i t_j \beta_i^{-1} = \psi(\sigma_i A_{0,j} \sigma_i^{-1})$ for $i, j \geq 1$. That is, we have to check that

$$(6.2a) \quad \beta_j t_j \beta_j^{-1} = t_{j+1} \quad (1 \leq j \leq n-1)$$

$$(6.2b) \quad \beta_k t_j \beta_k^{-1} = t_j \quad (k \geq 1 \text{ and } k \notin \{j-1, j\}),$$

$$(6.2c) \quad \beta_j t_{j+1} \beta_j^{-1} = t_{j+1}^{-1} t_j t_{j+1} \quad (1 \leq j \leq n-1).$$

But these relations can be checked in exactly the same way as the relations (6.1).

Finally, we have $\psi \circ \varphi(\beta_j) = \beta_j$ for all j , so $\psi \circ \varphi$ is the identity on $\mathcal{A}(B_n)$. \square

Definition 6.3. Let S be a commutative unital ring with an invertible element q .

- (1) The ordinary Hecke algebra $H_{n,S}(q^2)$ of type A is the quotient of the group algebra $S\mathcal{B}_n$ of the braid group, by the relations

$$\sigma_i - \sigma_i^{-1} = (q - q^{-1}) \quad (1 \leq i \leq n-1).$$

- (2) The affine Hecke algebra $\widehat{H}_{n,S}(q^2)$ is the quotient of the group algebra $S\mathcal{A}(B_n)$ of the Artin group of type B_n , by the relations

$$\beta_i - \beta_i^{-1} = (q - q^{-1}) \quad (1 \leq i \leq n - 1).$$

Since \mathcal{B}_n imbeds in $\widehat{\mathcal{B}}_n$, the ordinary Hecke algebra imbeds in the affine Hecke algebra. For $i \geq 1$, we denote the image of σ_i in the ordinary Hecke algebra (and the image of β_i in the affine Hecke algebra) by g_i . We denote the image of β_0 in the affine Hecke algebra by x_1 and define

$$x_j = g_{j-1} \cdots g_1 x_1 g_1 \cdots g_{j-1},$$

and

$$x'_j = g_{j-1} \cdots g_1 x_1 g_1^{-1} \cdots g_{j-1}^{-1},$$

for $1 \leq j \leq n$.

Corollary 6.4. *Let S be any commutative ring with identity and with an invertible element q . The affine Hecke algebra $\widehat{H}_{n,S}(q^2)$ is isomorphic to the S -algebra of affine braid diagrams, modulo the Hecke skein relation:*

$$\begin{array}{c} \diagup \diagdown \\ \diagdown \diagup \end{array} - \begin{array}{c} \diagdown \diagup \\ \diagup \diagdown \end{array} = (q - q^{-1}) \begin{array}{c} \diagup \\ \diagdown \end{array} \begin{array}{c} \diagdown \\ \diagup \end{array}.$$

Here, the figures indicate affine braid diagrams which are identical outside the region shown.

Proof. By Proposition 6.2, the Artin group $\mathcal{A}(B_n)$ is isomorphic to the group of affine braid diagrams. Hence the affine Hecke algebra is isomorphic to the algebra of affine braid diagrams, modulo the ideal generated by the relations $\sigma_i - \sigma_i^{-1} = (q - q^{-1})$. Since any affine braid diagram is isotopic to a product of the elementary diagrams σ_i , x_1 , and their inverses, the ideal in $S\widehat{\mathcal{B}}_n$ generated by the Hecke skein relations is the same as the ideal generated by the relations $\sigma_i - \sigma_i^{-1} = (q - q^{-1})$. \square

It is well known that the affine Hecke algebra $\widehat{H}_{n,S}(q^2)$ is a free module over the ordinary Hecke algebra $H_{n,S}(q^2)$, with basis consisting of Laurent monomials in the commuting elements x_j . We want to use the technique from Section 2 of this paper to show that the affine Hecke algebra has a basis as an $H_{n,S}(q^2)$ module consisting of ordered Laurent monomials in the non-commuting elements x'_j :

$$(x'_n)^{a_n} \cdots (x'_1)^{a_1}$$

This is a theorem of Lambropoulou ([18], Theorem 5), and is the Hecke algebra analogue of our Theorem 2.25.

When an affine braid diagram is written as a word in the generators $\sigma_i^{\pm 1}$ and $x_1^{\pm 1}$, it is already in standard position as an affine tangle diagram, cf. Definition 2.8. We give affine braid diagrams the standard orientation, so strands are oriented downward, and ordered according to the order of their initial vertices, from left to right. We use the same order for the stratification order, so an affine braid diagram is stratified if it is totally descending; that is, each crossing is encountered first as an over crossing.

Lemma 6.5. $\widehat{H}_{n,S}(q^2)$ is spanned by totally descending affine braid diagrams.

Proof. Same as the proof of Lemma 2.13. \square

Lemma 6.6. $\widehat{H}_{n,S}(q^2)$ is spanned by totally descending and flagpole descending affine braid diagrams.

Proof. Same as the proof of Proposition 2.18 (except there is no need to deal with closed loops). \square

The connector map c (see the paragraph before Lemma 2.21) maps affine braid diagrams to \mathbb{Z} -permutation diagrams, i.e., \mathbb{Z} -Brauer diagrams with vertical strands only. The set of \mathbb{Z} -permutation diagrams constitutes a multiplicative group in the \mathbb{Z} -Brauer algebra, isomorphic to the wreath product $\mathbb{Z} \wr S_n$.

Lemma 6.7. Two totally descending, flagpole descending affine braid diagrams with the same \mathbb{Z} -permutation diagram are isotopic.

Proof. This is a special case of Lemma 2.21. \square

Let d be a \mathbb{Z} -permutation diagram. Let α be the underlying permutation, and let a_j be the \mathbb{Z} -valued label of the j -th strand. Let T_α be the unique totally descending ordinary tangle diagram with underlying permutation α . (If $s_{i_1} \cdots s_{i_r}$ is a reduced expression for α , then $T_\alpha = g_{i_1}^{-1} \cdots g_{i_r}^{-1}$.) Define

$$T'_d = T_\alpha (x'_n)^{a_n} \cdots (x'_1)^{a_1}$$

It is straightforward to check that T'_d is totally descending, flagpole descending and has \mathbb{Z} -permutation diagram equal to d .

Proposition 6.8 ([18], Theorem 5). For any commutative unital ring S ,

$$\Sigma' = \{T'_d : d \text{ is a } \mathbb{Z}\text{-permutation diagram}\}$$

is an S -basis of $\widehat{H}_{n,S}(q^2)$.

Proof. Consider the generic ground ring for the affine Hecke algebra, $A = \mathbb{Z}[\mathbf{q}, \mathbf{q}^{-1}]$, where \mathbf{q} is an indeterminant. Since the affine Hecke algebra over A is a free A -module, it follows that for any ring S ,

$$\widehat{H}_{n,S}(q^2) = \widehat{H}_{n,A}(\mathbf{q}^2) \otimes_A S.$$

Therefore it suffices to prove the result for $\widehat{H}_{n,A}(\mathbf{q}^2)$.

By Lemmas 6.6 and 6.7, Σ' spans $\widehat{H}_{n,A}(\mathbf{q}^2)$. It remains to show that Σ' is linearly independent over A . Suppose we have a linear relation: $\sum_d r_d T'_d = 0$ in $\widehat{H}_{n,A}(\mathbf{q}^2)$. We can suppose that the non-zero coefficients are polynomials in $\mathbb{Z}[\mathbf{q}]$ and that they have no common factor, hence no common integer root.

The specialization $\widehat{H}_{n,\mathbb{Q}}(1)$ with $q = 1$ can be identified with the group algebra of $\mathbb{Z} \wr S_n$, and the element T'_d is thus identified with the group element d . These elements are linearly independent over \mathbb{Q} , so the relation $\sum_d r_d(1)T'_d = 0$ implies that $r_d(1) = 0$ for all d . Since the non-zero r_d have no common integer root, we must have $r_d = 0$ for all d . \square

Remark 6.9. The passage from Theorem 4 to Theorem 5 in [18] is reversible, i.e., the two theorems provide two different descriptions of the same basis of $\widehat{H}_{n,S}(q^2)$. Therefore, Proposition 6.8 implies the existence of Markov traces on the affine Hecke algebra and of Jones type invariants of links in the solid torus, as in [18], Sections 4 and 5.

Definition 6.10. Let S be a commutative unital ring with invertible element q . Let $r \geq 1$, and let u_1, \dots, u_r be additional invertible elements in S . The *cyclotomic Hecke algebra* $H_{n,S,r}(q^2; u_1, \dots, u_r)$ is the quotient of the affine Hecke algebra $\widehat{H}_{n,S}(q^2)$ by the polynomial relation $(x_1 - u_1) \cdots (x_1 - u_r) = 0$.

Let Σ'_r denote the set of all $T_\alpha (x'_n)^{a_n} \cdots (x'_1)^{a_1} \in \Sigma'$ such that $0 \leq a_j \leq r - 1$ for all j .

Corollary 6.11. *For any commutative unital ring S with invertible elements q, u_1, \dots, u_r , the cyclotomic Hecke algebra $H_{n,S,r}(q^2; u_1, \dots, u_r)$ is a free S -module with basis Σ'_r .*

Proof. Let $R = \mathbb{Z}[\mathbf{q}^{\pm 1}, \mathbf{u}_1^{\pm 1}, \dots, \mathbf{u}_r^{\pm 1}]$. For any S ,

$$H_{n,S,r}(q^2; u_1, \dots, u_r) = H_{n,R,r}(\mathbf{q}^2; \mathbf{u}_1, \dots, \mathbf{u}_r) \otimes_R S.$$

Therefore, it suffices to prove the result for the cyclotomic Hecke algebra over R .

As in the proof of Proposition 3.6, it follows from Proposition 6.8 that Σ'_r spans $H_{n,R,r}(q^2; \mathbf{u}_1, \dots, \mathbf{u}_r)$. Moreover, Σ'_r is linearly independent over the field of fractions F of R , because the cyclotomic Hecke algebra over F is an F -vector space of dimension $r^n n!$, and Σ'_r is a spanning set of the same cardinality. \square

REFERENCES

1. Daniel Allcock, *Braid pictures for Artin groups*, Trans. Amer. Math. Soc. **354** (2002), no. 9, 3455–3474 (electronic). MR MR1911508 (2003f:20053)
2. Susumu Ariki, *Representations of quantum algebras and combinatorics of Young tableaux*, University Lecture Series, vol. 26, American Mathematical Society, Providence, RI, 2002, Translated from the 2000 Japanese edition and revised by the author. MR MR1911030 (2004b:17022)
3. Susumu Ariki, Andrew Mathas, and Hebing Rui, *Cyclotomic Nazarov-Wenzl algebras*, Nagoya Math. J. **182** (2006), 47–134. MR MR2235339
4. Joan S. Birman, *Braids, links, and mapping class groups*, Princeton University Press, Princeton, N.J., 1974, Annals of Mathematics Studies, No. 82. MR MR0375281 (51 #11477)
5. Joan S. Birman and Hans Wenzl, *Braids, link polynomials and a new algebra*, Trans. Amer. Math. Soc. **313** (1989), no. 1, 249–273. MR 90g:57004
6. John Crisp, *Injective maps between Artin groups*, Geometric group theory down under (Canberra, 1996), de Gruyter, Berlin, 1999, pp. 119–137. MR MR1714842 (2001b:20064)
7. John Crisp and Luis Paris, *Artin groups of type B and D*, Adv. Geom. **5** (2005), no. 4, 607–636. MR MR2174484 (2006g:20056)
8. John Enyang, *Specht modules and semisimplicity criteria for Brauer and Birman-Murakami-Wenzl algebras*, J. Algebraic Combin. **26** (2007), no. 3, 291–341. MR MR2348099
9. Frederick M. Goodman, *Cellularity of cyclotomic Birman-Wenzl-Murakami algebras*, preprint (2008), arXiv:0801.0306.
10. Frederick M. Goodman and Holly Hauschild, *Affine Birman-Wenzl-Murakami algebras and tangles in the solid torus*, Fund. Math. **190** (2006), 77–137. MR MR2232856
11. Frederick M. Goodman and Holly Hauschild Mosley, *Cyclotomic Birman-Wenzl-Murakami algebras II: Admissibility relations and freeness*, preprint (2006, Revised 2007), arXiv:math/0612065.
12. J. J. Graham and G. I. Lehrer, *Cellular algebras*, Invent. Math. **123** (1996), no. 1, 1–34. MR MR1376244 (97h:20016)
13. Reinhard Häring-Oldenburg, *Cyclotomic Birman-Murakami-Wenzl algebras*, J. Pure Appl. Algebra **161** (2001), no. 1-2, 113–144. MR MR1834081 (2002c:20055)
14. Vaughan F. R. Jones, *A polynomial invariant for knots via von Neumann algebras*, Bull. Amer. Math. Soc. (N.S.) **12** (1985), no. 1, 103–111. MR MR766964 (86e:57006)
15. Louis H. Kauffman, *An invariant of regular isotopy*, Trans. Amer. Math. Soc. **318** (1990), no. 2, 417–471. MR MR958895 (90g:57007)
16. Sofia Lambropoulou, *A study of braids in 3-manifolds*, Ph.D. Thesis, Warwick (1993).
17. ———, *Solid torus links and Hecke algebras of B-type*, Proceedings of the Conference on Quantum Topology (Manhattan, KS, 1993), World Sci. Publ., River Edge, NJ, 1994, pp. 225–245. MR MR1309934 (96a:57020)
18. ———, *Knot theory related to generalized and cyclotomic Hecke algebras of type B*, J. Knot Theory Ramifications **8** (1999), no. 5, 621–658. MR MR1693556 (2000k:57011)
19. Andrew Mathas, *Seminormal forms and Gram determinants for cellular algebras*, to appear in J. Reine Angew. Math., with an appendix by Marcos Soriano.

20. Jon McCammond, *Noncrossing partitions in surprising locations*, Amer. Math. Monthly **113** (2006), no. 7, 598–610. MR MR2252931 (2007c:05015)
21. Hugh Morton and Paweł Traczyk, *Knots and algebras*, Contribuciones Matemáticas en homenaje al profesor D. Antonio Plans Sanz de Bremond (E. Martín-Peindador and A. Rodez Usan, eds.), University of Zaragoza, Zaragoza, 1990, pp. 201–220.
22. Hugh Morton and Antony Wassermann, *A basis for the Birman-Wenzl algebra*, Unpublished manuscript (1989, revised 2000), 1–29.
23. Jun Murakami, *The Kauffman polynomial of links and representation theory*, Osaka J. Math. **24** (1987), no. 4, 745–758. MR MR927059 (89c:57007)
24. Maxim Nazarov, *Young's orthogonal form for Brauer's centralizer algebra*, J. Algebra **182** (1996), no. 3, 664–693. MR MR1398116 (97m:20057)
25. Andrei Okounkov and Anatoly Vershik, *A new approach to representation theory of symmetric groups*, Selecta Math. (N.S.) **2** (1996), no. 4, 581–605. MR MR1443185 (99g:20024)
26. Rosa Orellana and Arun Ram, *Affine braids, Markov traces and the category O* , preprint, 2004, arXiv:math.RT/0401317.
27. Vladimir Turaev, *The Conway and Kauffman modules of a solid torus*, Zap. Nauchn. Sem. Leningrad. Otdel. Mat. Inst. Steklov. (LOMI) **167** (1988), no. Issled. Topol. 6, 79–89, 190. MR MR964255 (90f:57012)
28. Hans Wenzl, *On the structure of Brauer's centralizer algebras*, Ann. of Math. (2) **128** (1988), no. 1, 173–193. MR MR951511 (89h:20059)
29. ———, *Quantum groups and subfactors of type B , C , and D* , Comm. Math. Phys. **133** (1990), no. 2, 383–432. MR MR1090432 (92k:17032)
30. Stewart Wilcox and Shona Yu, in preparation (2006).
31. ———, *The cyclotomic BMW algebra associated with the two string type B braid group*, preprint (2006), arXiv:math/0611518.
32. Shona Yu, *The cyclotomic Birman–Murakami–Wenzl algebras*, Ph.D. Thesis, University of Sydney (2007).

DEPARTMENT OF MATHEMATICS, UNIVERSITY OF IOWA, IOWA CITY, IOWA
E-mail address: `goodman@math.uiowa.edu`

DEPARTMENT OF MATHEMATICS, GRINNELL COLLEGE, GRINNELL, IOWA
E-mail address: `HAUSCHIL@GRINNELL.EDU`