

TOTAL POSITIVITY: TESTS AND PARAMETRIZATIONS

SERGEY FOMIN AND ANDREI ZELEVINSKY

INTRODUCTION

A matrix is *totally positive* (resp. *totally nonnegative*) if all its minors are positive (resp. nonnegative) real numbers. The first systematic study of these classes of matrices was undertaken in the 1930s by F. R. Gantmacher and M. G. Krein [20, 21, 22], who established their remarkable spectral properties (in particular, an $n \times n$ totally positive matrix x has n distinct positive eigenvalues). Earlier, I. J. Schoenberg [41] discovered the connection between total nonnegativity and the following *variation-diminishing property*: the number of sign changes in a vector does not increase upon multiplying by x .

Total positivity found numerous applications and was studied from many different angles. An incomplete list includes: oscillations in mechanical systems (the original motivation in [22]), stochastic processes and approximation theory [25, 28], Pólya frequency sequences [28, 40], representation theory of the infinite symmetric group and the Edrei-Thoma theorem [13, 44], planar resistor networks [11], unimodality and log-concavity [42], and theory of immanants [43]. Further references can be found in S. Karlin's book [28] and in the surveys [2, 5, 38].

In this paper, we focus on the following two problems:

- (i) *parametrizing* all totally nonnegative matrices;
- (ii) *testing* a matrix for total positivity.

Our interest in these problems stemmed from a surprising representation-theoretic connection between total positivity and canonical bases for quantum groups, discovered by G. Lusztig [33] (cf. also the surveys [31, 34]). Among other things, he extended the subject by defining totally positive and totally nonnegative elements for any reductive group. Further development of these ideas in [3, 4, 15, 17] aims at generalizing the whole body of classical determinantal calculus to any semisimple group.

As it often happens, putting things in a more general perspective shed new light on this classical subject. In the next two sections of this paper, we provide self-contained proofs (many of them new) of the fundamental results on problems (i)–(ii), due to A. Whitney [46], C. Loewner [32], C. Cryer [9, 10], and M. Gasca and J. M. Peña [23]. The rest of the paper presents more recent results obtained in [15]: a family of efficient total positivity criteria, and explicit formulas for expanding a generic matrix into a product of elementary Jacobi matrices. These results and their proofs can be generalized to arbitrary semisimple groups [4, 15], but we do not discuss this here.

Our approach to the subject relies on two combinatorial constructions. The first one is well known: it associates a totally nonnegative matrix to a planar directed graph with positively weighted edges (in fact, every totally nonnegative matrix can be obtained in this way [6]). Our second combinatorial tool was introduced in [15]; it is a particular class of colored pseudoline arrangements that we call the *double wiring diagrams*.

Date: August 1999.

PLANAR NETWORKS

To the uninitiated, it might be unclear that totally positive matrices of arbitrary order exist at all. As a warm-up, we invite the reader to check that every matrix given by

$$(1) \quad \begin{bmatrix} d & dh & dhi \\ bd & bdh+e & bdhi+eg+ei \\ abd & abdh+ae+ce & abdhi+(a+c)e(g+i)+f \end{bmatrix},$$

where the numbers $a, b, c, d, e, f, g, h, i$ are positive, is totally positive. It will follow from the results below that *every* 3×3 totally positive matrix has this form.

We will now describe a general procedure that produces totally nonnegative matrices. In what follows, a *planar network* (Γ, ω) is an acyclic directed planar graph Γ whose edges e are assigned scalar *weights* $\omega(e)$. In all of our examples (Figures 1–5), we assume the edges of Γ *directed left to right*. Also, each of our networks will have n *sources* and n *sinks*, located at the left (resp. right) edge of the picture, and numbered bottom-to-top.

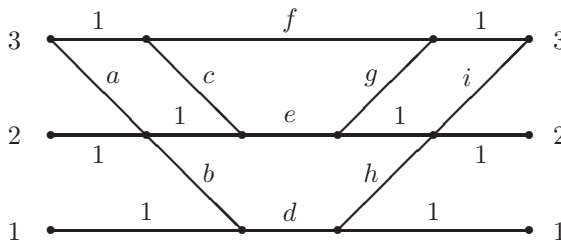

FIGURE 1. A planar network

The weight of a directed path in Γ is defined as the product of the weights of its edges. The *weight matrix* $x(\Gamma, \omega)$ is an $n \times n$ matrix whose (i, j) -entry is the sum of weights of all paths from the source i to the sink j . For example, the weight matrix of the network in Figure 1 is given by (1).

The minors of the weight matrix of a planar network have an important combinatorial interpretation, which can be traced to B. Lindström [30] and further to S. Karlin and G. McGregor [29] (implicit), and whose many applications were given by I. Gessel and G. X. Viennot [26, 27].

In what follows, $\Delta_{I,J}(x)$ denotes the minor of a matrix x with the row set I and the column set J .

The weight of a collection of directed paths in Γ is defined to be the product of their weights.

Lemma 1. (Lindström’s Lemma) *A minor $\Delta_{I,J}$ of the weight matrix of a planar network is equal to the sum of weights of all collections of vertex-disjoint paths that connect the sources labeled by I with the sinks labeled by J .*

To illustrate, consider the matrix x in (1). We have, e.g., $\Delta_{23,23}(x) = bcdegh + bdfh + fe$, which also equals the sum of the weights of the three vertex-disjoint path collections in Figure 1 that connect sources 2 and 3 to sinks 2 and 3.

Proof. It suffices to prove the lemma for the determinant of the whole weight matrix $x = x(\Gamma, \omega)$, i.e., for the case $I = J = [1, n]$. Expanding the determinant,

we obtain

$$(2) \quad \det(x) = \sum_w \sum_{\pi} \operatorname{sgn}(w) \omega(\pi) ,$$

the sum being over all permutations w in the symmetric group \mathcal{S}_n , and over all collections of paths $\pi = (\pi_1, \dots, \pi_n)$ such that π_i joins the source i with the sink $w(i)$. Any collection π of vertex-disjoint paths is associated with the identity permutation; hence $\omega(\pi)$ appears in (2) with the positive sign. We need to show that all other terms in (2) cancel out. Deforming Γ a bit if necessary, we may assume that no two vertices lie on the same vertical line. This makes the following involution on the non-vertex-disjoint collections of paths well-defined: take the rightmost point of intersection of two paths in π , and switch the parts of these paths lying to the right of this point. This involution preserves the weight of π , while changing the sign of the associated permutation w ; the corresponding pairing of terms in (2) provides the desired cancellation. \square

Corollary 2. *If a planar network has nonnegative real weights, then its weight matrix is totally nonnegative.*

An aside: note that the weight matrix of the network

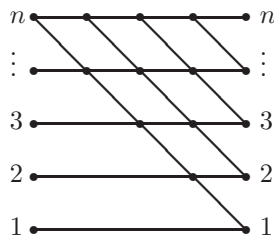

(with unit edge weights) is the “Pascal triangle”

$$\begin{bmatrix} 1 & 0 & 0 & 0 & 0 & \dots \\ 1 & 1 & 0 & 0 & 0 & \dots \\ 1 & 2 & 1 & 0 & 0 & \dots \\ 1 & 3 & 3 & 1 & 0 & \dots \\ 1 & 4 & 6 & 4 & 1 & \dots \\ \dots & \dots & \dots & \dots & \dots & \dots \end{bmatrix} ,$$

which is totally nonnegative by Corollary 2. Similar arguments can be used to show total nonnegativity of various other combinatorial matrices, such as the matrices of q -binomial coefficients, Stirling numbers of both kinds, etc.

We call a planar network Γ *totally connected* if, for any two subsets $I, J \subset [1, n]$ of the same cardinality, there exists a collection of vertex-disjoint paths in Γ connecting the sources labeled by I with the sinks labeled by J .

Corollary 3. *If a totally connected planar network has positive weights, then its weight matrix is totally positive.*

For any n , let Γ_0 denote the network shown in Figure 2. Direct inspection shows that Γ_0 is totally connected.

Corollary 4. *For any choice of positive weights $\omega(e)$, the weight matrix $x(\Gamma_0, \omega)$ is totally positive.*

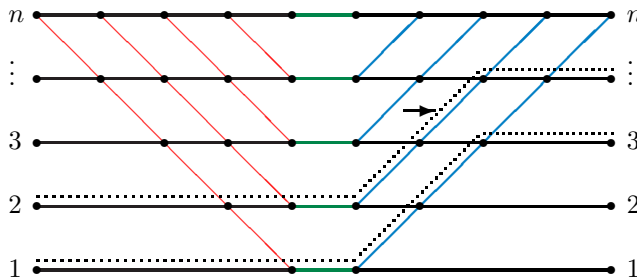
FIGURE 2. Planar network Γ_0

It turns out that this construction produces *all* totally positive matrices; this result is essentially equivalent to A. Whitney's Reduction Theorem [46], and can be sharpened as follows. Call an edge of Γ_0 *essential* if it either is slanted, or is one of the n horizontal edges in the middle of the network. Note that Γ_0 has exactly n^2 essential edges. A weighting ω of Γ_0 is *essential* if $\omega(e) \neq 0$ for any essential edge e , and $\omega(e) = 1$ for all other edges.

Theorem 5. *The map $\omega \mapsto x(\Gamma_0, \omega)$ restricts to a bijection between the set of all essential positive weightings of Γ_0 and the set of all totally positive $n \times n$ matrices.*

The proof of this theorem will use the following notions. A minor $\Delta_{I,J}$ is called *solid* if both I and J consist of several consecutive indices; if furthermore $I \cup J$ contains 1, then $\Delta_{I,J}$ is called *initial* (see Figure 3). Each matrix entry is the lower-right corner of exactly one initial minor; thus the total number of such minors is n^2 .

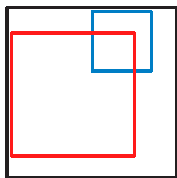

FIGURE 3. Initial minors

Lemma 6. *The n^2 weights of essential edges in an essential weighting ω of Γ_0 are related to the n^2 initial minors of the weight matrix $x = x(\Gamma_0, \omega)$ by an invertible monomial transformation. Thus an essential weighting ω of Γ_0 is uniquely recovered from x .*

Proof. The network Γ_0 has the following easily verified property: for any set I of k consecutive indices in $[1, n]$, there is a unique collection of k vertex-disjoint paths connecting the sources labeled by $[1, k]$ (resp. by I) with the sinks labeled by I (resp. by $[1, k]$). These paths are shown by dotted lines in Figure 2, for $k = 2$ and $I = [3, 4]$. By Lindström's Lemma, every initial minor Δ of $x(\Gamma_0, \omega)$ is equal to the product of the weights of essential edges covered by this family of paths. Notice that among these edges, there is always a unique *uppermost* essential edge $e(\Delta)$ (indicated by the arrow in Figure 2). Furthermore, the map $\Delta \mapsto e(\Delta)$ is a bijection between initial minors and essential edges. It follows that the weight of

each essential edge $e = e(\Delta)$ is equal to Δ times a Laurent monomial in some initial minors Δ' whose associated edges $e(\Delta')$ are located below e . \square

To illustrate Lemma 6, consider the special case $n = 3$. The network Γ_0 is shown in Figure 1; its essential edges have the weights a, b, \dots, i . The weight matrix $x(\Gamma_0, \omega)$ is given in (1). Its initial minors are given by the monomials

$$\begin{aligned} \Delta_{1,1} &= \underline{d} & \Delta_{1,2} &= d\underline{h} & \Delta_{1,3} &= dh\underline{i} \\ \Delta_{2,1} &= \underline{b}d & \Delta_{12,12} &= d\underline{e} & \Delta_{12,23} &= de\underline{g}h \\ \Delta_{3,1} &= \underline{a}bd & \Delta_{23,12} &= b\underline{c}de & \Delta_{123,123} &= de\underline{f} \end{aligned}$$

where for each minor Δ , the “leading entry” $\omega(e(\Delta))$ is underlined.

To complete the proof of Theorem 5, it remains to show that every totally positive matrix x has the form $x(\Gamma_0, \omega)$ for some essential positive weighting ω . By Lemma 6, such an ω can be chosen so that x and $x(\Gamma_0, \omega)$ will have the same initial minors. Thus our claim will follow from the lemma below.

Lemma 7. *A square matrix x is uniquely determined by its initial minors provided all these minors are nonzero.*

Proof. Let us show that each matrix entry x_{ij} of x is uniquely determined by the initial minors. If $i = 1$ or $j = 1$, there is nothing to prove, since x_{ij} is itself an initial minor. Assume that $\min(i, j) > 1$. Let Δ be the initial minor whose last row is i and last column is j , and let Δ' be the initial minor obtained from Δ by deleting this row and this column. Then $\Delta = \Delta'x_{ij} + P$, where P is a polynomial in the matrix entries $x_{i'j'}$ with $(i', j') \neq (i, j)$ and $i' \leq i, j' \leq j$. Using induction on $i + j$, we can assume that each $x_{i'j'}$ that occurs in P is uniquely determined by the initial minors, so the same is true for $x_{ij} = (\Delta - P)/\Delta'$. This completes the proofs of Lemma 7 and Theorem 5. \square

Theorem 5 describes a *parametrization* of totally positive matrices by n^2 -tuples of positive reals, providing a partial answer (one of the many possible, as we will see) to the first problem stated in the introduction. The second problem—that of *testing* total positivity of a matrix—can also be solved using this theorem, as we will now explain.

An $n \times n$ matrix has altogether $\binom{2n}{n} - 1$ minors. This makes it impractical to test positivity of every single minor. It is desirable to find efficient criteria for total positivity that would only check a small fraction of all minors.

Example 8. A 2×2 matrix $x = \begin{bmatrix} a & b \\ c & d \end{bmatrix}$ has $\binom{4}{2} - 1 = 5$ minors: four matrix entries and the determinant $\Delta = ad - bc$. To test that x is totally positive, it is enough to check positivity of a, b, c , and Δ ; then $d = (\Delta + bc)/a > 0$.

The following theorem generalizes this example to matrices of arbitrary size; it is a direct corollary of Theorem 5 and Lemmas 6 and 7.

Theorem 9. *A square matrix is totally positive if and only if all its initial minors (see Figure 3) are positive.*

This criterion involves n^2 minors, and it can be shown that this number cannot be lessened. Theorem 9 was proved by M. Gasca and J. M. Peña [23, Theorem 4.1] (for rectangular matrices); it also follows from C. Cryer’s results in [9]. Theorem 9 is an enhancement of the 1912 criterion by M. Fekete [14], who proved that the positivity of all solid minors of a matrix implies its total positivity.

THEOREMS OF WHITNEY AND LOEWNER

In this paper, we shall only consider *invertible* totally nonnegative $n \times n$ matrices. Although these matrices have real entries, it is convenient to view them as elements of the general linear group $G = GL_n(\mathbb{C})$. We denote by $G_{\geq 0}$ (resp. $G_{> 0}$) the set of all totally nonnegative (resp. totally positive) matrices in G . The structural theory of these matrices begins with the following basic observation, which is an immediate corollary of the Binet-Cauchy formula.

Proposition 10. *Both $G_{\geq 0}$ and $G_{> 0}$ are closed under matrix multiplication. Furthermore, if $x \in G_{\geq 0}$ and $y \in G_{> 0}$ then both xy and yx belong to $G_{> 0}$.*

Combining this proposition with the foregoing results, we will prove the following theorem of A. Whitney [46].

Theorem 11. (Whitney’s Theorem) *Every invertible totally nonnegative matrix is the limit of a sequence of totally positive matrices.*

Thus $G_{\geq 0}$ is the closure of $G_{> 0}$ in G . (The condition of invertibility in Theorem 11 can in fact be lifted.)

Proof. First let us show that the identity matrix I lies in the closure of $G_{> 0}$. By Corollary 4, it suffices to show that $I = \lim_{N \rightarrow \infty} x(\Gamma_0, \omega_N)$ for some sequence of positive weightings ω_N of the network Γ_0 . Note that the map $\omega \mapsto x(\Gamma_0, \omega)$ is continuous, and choose any sequence of positive weightings that converges to the weighting ω_0 defined by $\omega_0(e) = 1$ (resp. 0) for all horizontal (resp. slanted) edges e . Clearly, $x(\Gamma_0, \omega_0) = I$, as desired.

To complete the proof, write any matrix $x \in G_{\geq 0}$ as $x = \lim_{N \rightarrow \infty} x \cdot x(\Gamma_0, \omega_N)$, and notice that all matrices $x \cdot x(\Gamma_0, \omega_N)$ are totally positive by Proposition 10. \square

The following description of the multiplicative monoid $G_{\geq 0}$ was first given by C. Loewner [32] under the name “Whitney’s Theorem”; it can indeed be deduced from [46].

Theorem 12. (Loewner-Whitney Theorem) *Any invertible totally nonnegative matrix is a product of elementary Jacobi matrices with nonnegative matrix entries.*

Here “elementary Jacobi matrix” is a matrix $x \in G$ that differs from I in a single entry located either on the main diagonal, or immediately above or below it.

Proof. We start with an inventory of elementary Jacobi matrices. Let $E_{i,j}$ denote the $n \times n$ matrix whose (i, j) -entry is 1 while all other entries are 0. For $t \in \mathbb{C}$ and $i = 1, \dots, n-1$, let

$$x_i(t) = I + tE_{i,i+1} = \begin{bmatrix} 1 & \cdots & 0 & 0 & \cdots & 0 \\ \cdots & \cdots & \cdots & \cdots & \cdots & \cdots \\ 0 & \cdots & 1 & t & \cdots & 0 \\ 0 & \cdots & 0 & 1 & \cdots & 0 \\ \cdots & \cdots & \cdots & \cdots & \cdots & \cdots \\ 0 & \cdots & 0 & 0 & \cdots & 1 \end{bmatrix}$$

and

$$x_{\bar{i}}(t) = I + tE_{i+1,i} = (x_i(t))^T$$

(the transpose of $x_i(t)$). Also, for $i = 1, \dots, n$ and $t \neq 0$, let

$$x_{\circledast}(t) = I + (t-1)E_{i,i},$$

the diagonal matrix with i th diagonal entry equal to t and all other diagonal entries equal to 1. Thus elementary Jacobi matrices are precisely the matrices of the form $x_i(t)$, $x_{\bar{i}}(t)$, and $x_{\textcircled{i}}(t)$. An easy check shows that they are totally nonnegative for any $t > 0$.

For any word $\mathbf{i} = (i_1, \dots, i_l)$ in the alphabet

$$(3) \quad \mathcal{A} = \{1, \dots, n-1, \textcircled{1}, \dots, \textcircled{n}, \bar{1}, \dots, \overline{n-1}\}$$

we define the *product map* $x_{\mathbf{i}} : (\mathbb{C} \setminus \{0\})^l \rightarrow G$ by

$$(4) \quad x_{\mathbf{i}}(t_1, \dots, t_l) = x_{i_1}(t_1) \cdots x_{i_l}(t_l).$$

(Actually, $x_{\mathbf{i}}(t_1, \dots, t_l)$ is well defined as long as the right-hand side of (4) does not involve any factors of the form $x_{\textcircled{i}}(0)$.) To illustrate, the word $\mathbf{i} = \textcircled{1} \bar{1} \textcircled{2} 1$ gives rise to

$$\begin{aligned} x_{\mathbf{i}}(t_1, t_2, t_3, t_4) &= \begin{bmatrix} t_1 & 0 \\ 0 & 1 \end{bmatrix} \begin{bmatrix} 1 & 0 \\ t_2 & 1 \end{bmatrix} \begin{bmatrix} 1 & 0 \\ 0 & t_3 \end{bmatrix} \begin{bmatrix} 1 & t_4 \\ 0 & 1 \end{bmatrix} \\ &= \begin{bmatrix} t_1 & t_1 t_4 \\ t_2 & t_2 t_4 + t_3 \end{bmatrix}. \end{aligned}$$

We will interpret each matrix $x_{\mathbf{i}}(t_1, \dots, t_l)$ as the weight matrix of a planar network. First note that any elementary Jacobi matrix is the weight matrix of a “chip” of one of the three kinds shown in Figure 4. In each “chip,” all edges but one have weight 1; the distinguished edge has weight t . Slanted edges connect horizontal levels i and $i + 1$, counting from the bottom; in all examples in Figure 4, $i = 2$.

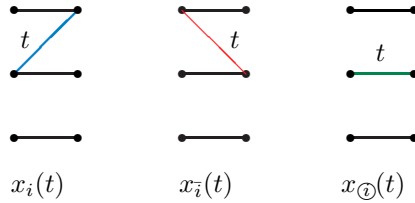

FIGURE 4. Elementary “chips”

The weighted planar network $(\Gamma(\mathbf{i}), \omega(t_1, \dots, t_l))$ is then constructed by concatenating the “chips” corresponding to consecutive factors $x_{i_k}(t_k)$, as shown in Figure 5. It is easy to see that concatenation of planar networks corresponds to multiplying their weight matrices. We conclude that the product $x_{\mathbf{i}}(t_1, \dots, t_l)$ of elementary Jacobi matrices equals the weight matrix $x(\Gamma(\mathbf{i}), \omega(t_1, \dots, t_l))$.

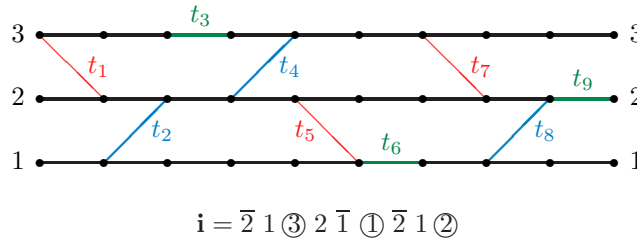

FIGURE 5. Planar network $\Gamma(\mathbf{i})$

In particular, the network (Γ_0, ω) appearing in Figure 2 and Theorem 5 (more precisely, its equivalent deformation) corresponds to some special word \mathbf{i}_{\max} of length n^2 ; instead of defining \mathbf{i}_{\max} formally, we just write it for $n=4$:

$$\mathbf{i}_{\max} = (\bar{3}, \bar{2}, \bar{3}, \bar{1}, \bar{2}, \bar{3}, \textcircled{1}, \textcircled{2}, \textcircled{3}, \textcircled{4}, 3, 2, 3, 1, 2, 3) .$$

In view of this, Theorem 5 can be reformulated as follows.

Theorem 13. *The product map $x_{\mathbf{i}_{\max}}$ restricts to a bijection between n^2 -tuples of positive real numbers and totally positive $n \times n$ matrices.*

We will prove the following refinement of Theorem 12, which is a reformulation of its original version [32].

Theorem 14. *Every matrix $x \in G_{\geq 0}$ can be written as $x = x_{\mathbf{i}_{\max}}(t_1, \dots, t_{n^2})$, for some $t_1, \dots, t_{n^2} \geq 0$.*

(Since x is invertible, we must in fact have $t_k > 0$ for $\frac{n(n-1)}{2} < k \leq \frac{n(n+1)}{2}$, i.e., for those indices k for which the corresponding entry of \mathbf{i}_{\max} is of the form \textcircled{i} .)

Proof. The following key lemma is due to C. Cryer [9].

Lemma 15. *The leading principal minors $\Delta_{[1,k],[1,k]}$ of a matrix $x \in G_{\geq 0}$ are positive, for $k=1, \dots, n$.*

Proof. Using induction on n , it suffices to show that $\Delta_{[1,n-1],[1,n-1]}(x) > 0$. Let $\Delta^{i,j}(x)$ (resp. $\Delta^{i',j'}(x)$) denote the minor of x obtained by deleting the row i and the column j (resp. rows i and i' , and columns j and j'). Then, for any $1 \leq i < i' \leq n$ and $1 \leq j < j' \leq n$, one has

$$(5) \quad \Delta^{i',j'}(x)\Delta^{i,j}(x) - \Delta^{i',j}(x)\Delta^{i,j'}(x) = \det(x)\Delta^{ii',jj'}(x)$$

as an immediate consequence of Jacobi's formula for minors of the inverse matrix (see, e.g., [7, Lemma 9.2.10]). The determinantal identity (5) was proved by P. Desnanot as early as in 1819 (see [37, pp. 140-142]); it is sometimes called ‘‘Lewis Carroll's identity,’’ due to the role it plays in C. L. Dodgson's condensation method [12, pp. 170–180].

Now suppose that $\Delta^{n,n}(x) = 0$ for some $x \in G_{\geq 0}$. Since x is invertible, we have $\Delta^{i,n}(x) > 0$ and $\Delta^{n,j}(x) > 0$ for some indices $i, j < n$. Using (5) with $i' = j' = n$, we arrive at a desired contradiction by

$$0 > -\Delta^{n,j}(x)\Delta^{i,n}(x) = \det(x)\Delta^{in,jn}(x) \geq 0. \quad \square$$

We are now ready to complete the proof of Theorem 14. Any matrix $x \in G_{\geq 0}$ is by Theorem 11 a limit of totally positive matrices x_N , each of which can by Theorem 13 be factored as $x_N = x_{\mathbf{i}_{\max}}(t_1^{(N)}, \dots, t_{n^2}^{(N)})$ with all $t_k^{(N)}$ positive. It suffices to show that the sequence $s_N = \sum_{k=1}^{n^2} t_k^{(N)}$ converges; then the standard compactness argument will imply that the sequence of vectors $(t_1^{(N)}, \dots, t_{n^2}^{(N)})$ contains a converging subsequence, whose limit (t_1, \dots, t_{n^2}) will provide the desired factorization $x = x_{\mathbf{i}_{\max}}(t_1, \dots, t_{n^2})$. To see that (s_N) converges, we use the explicit formula

$$\begin{aligned} s_N &= \sum_{i=1}^n \frac{\Delta_{[1,i],[1,i]}(x_N)}{\Delta_{[1,i-1],[1,i-1]}(x_N)} \\ &+ \sum_{i=1}^{n-1} \frac{\Delta_{[1,i-1] \cup \{i+1\}, [1,i]}(x_N) + \Delta_{[1,i], [1,i-1] \cup \{i+1\}}(x_N)}{\Delta_{[1,i], [1,i]}(x_N)} \end{aligned}$$

(to prove this, compute the minors on the right with the help of Lindström’s Lemma and simplify). Thus s_N is expressed as a Laurent polynomial in the minors of x_N whose denominators only involve leading principal minors $\Delta_{[1,k],[1,k]}$. By Lemma 15, as x_N converges to x , this Laurent polynomial converges to its value at x . This completes the proofs of Theorems 12 and 14. \square

DOUBLE WIRING DIAGRAMS AND
TOTAL POSITIVITY CRITERIA

We will now give another proof of Theorem 9, which will include it into a family of “optimal” total positivity criteria that correspond to combinatorial objects called *double wiring diagrams*. This notion is best explained by an example, such as the one given in Figure 6. A double wiring diagram consists of two families of n piecewise-straight lines (each family colored with one of the two colors), the crucial requirement being that each pair of lines of like color intersect exactly once.

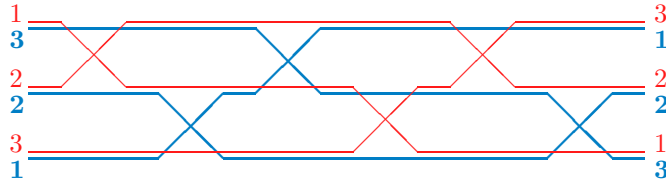

FIGURE 6. Double wiring diagram

The lines in a double wiring diagram are numbered separately within each color. We then assign to every *chamber* of a diagram a pair of subsets of the set $[1, n] = \{1, \dots, n\}$: each subset indicates which lines of the corresponding color pass *below* that chamber; see Figure 7.

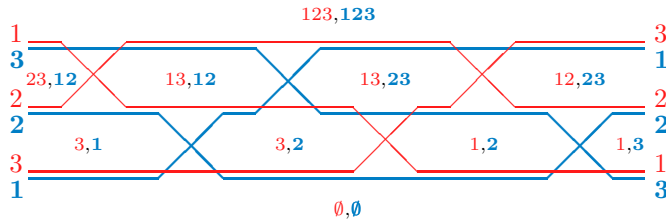

FIGURE 7. Chamber minors

Thus every chamber is naturally associated with a minor $\Delta_{I,J}$ of an $n \times n$ matrix $x = (x_{ij})$ (we call it a *chamber minor*) that occupies the rows and columns specified by the sets I and J written into that chamber. In our running example, there are 9 chamber minors (the total number is always n^2), namely $x_{31}, x_{32}, x_{12}, x_{13}, \Delta_{23,12}, \Delta_{13,12}, \Delta_{13,23}, \Delta_{12,23}$, and $\Delta_{123,123} = \det(x)$.

Theorem 16. [15] *Every double wiring diagram gives rise to the following criterion: an $n \times n$ matrix is totally positive if and only if all its n^2 chamber minors are positive.*

The criterion in Theorem 9 is a special case of Theorem 16, and arises from the “lexicographically minimal” double wiring diagram, shown in Figure 8 for $n = 3$.

Proof. We will actually prove the following statement that implies Theorem 16.

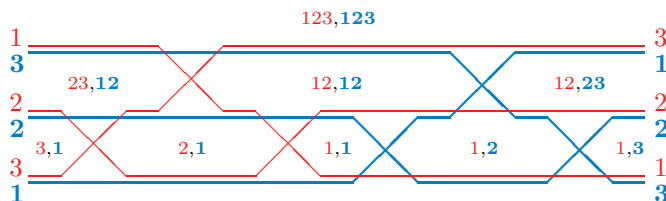

FIGURE 8. Lexicographically minimal diagram

Theorem 17. [15] *Every minor of a generic square matrix can be written as a rational expression in the chamber minors of a given double wiring diagram, and moreover this rational expression is subtraction-free, i.e., all coefficients in the numerator and denominator are positive.*

Two double wiring diagrams are called *isotopic* if they have the same collections of chamber minors. The terminology suggests what is really going on here: two isotopic diagrams have the same “topology.” From now on, we will treat such diagrams as indistinguishable from each other.

We will deduce Theorem 17 from the following fact: any two double wiring diagrams can be transformed into each other by a sequence of local “moves” of three different kinds, shown in Figure 9. (This is a direct corollary of a theorem of G. Ringel [39]. It can also be derived from the Tits theorem on reduced words in the symmetric group; cf. (7)–(8) below.)

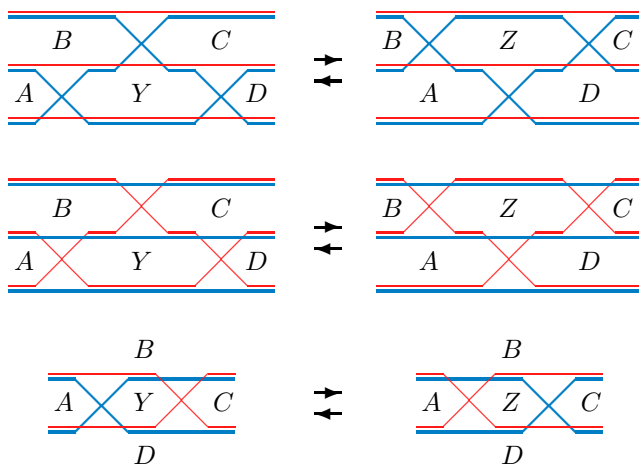

FIGURE 9. Local “moves”

Notice that each local move exchanges a single chamber minor Y with another chamber minor Z , and keeps all other chamber minors in place.

Lemma 18. *Whenever two double wiring diagrams differ by a single local move of one of the three types shown in Figure 9, the chamber minors appearing there satisfy the identity $AC + BD = YZ$.*

The three-term determinantal identities of Lemma 18 are well known, although not in this disguised form. The last of these identities is nothing but the identity

(5), applied to various submatrices of an $n \times n$ matrix. The identities corresponding to the top two “moves” in Figure 9 are special instances of the classical Grassmann-Plücker relations (see, e.g., [18, (15.53)]), and were obtained by P. Desnanot alongside (5) in the same 1819 publication that we mentioned before.

Theorem 17 is now proved as follows. We first note that any minor appears as chamber minor in some double wiring diagram. Therefore, it suffices to show that the chamber minors of one diagram can be written as subtraction-free rational expressions in the chamber minors of any other diagram. This is a direct corollary of Lemma 18 combined with the fact that any two diagrams are related by a sequence of local moves: indeed, each local move replaces Y by $(AC + BD)/Z$, or Z by $(AC + BD)/Y$. \square

Implicit in the above proof is an important combinatorial structure lying behind Theorems 16 and 17: the graph Φ_n whose vertices are the (isotopy classes of) double wiring diagrams, and whose edges correspond to local moves. The study of Φ_n is an interesting problem in itself. The first nontrivial example is the graph Φ_3 shown in Figure 10. It has 34 vertices, corresponding to 34 different total positivity criteria. Each of these criteria tests 9 minors of a 3×3 matrix. Five of these minors, viz. x_{31} , x_{13} , $\Delta_{23,12}$, $\Delta_{12,23}$, and $\det(x)$, correspond to the “unbounded” chambers that lie on the periphery of every double wiring diagram; they are common to all 34 criteria. The other four minors correspond to the bounded chambers, and depend on the choice of a diagram. For example, the criterion derived from Figure 7 involves “bounded” chamber minors $\Delta_{3,2}$, $\Delta_{1,2}$, $\Delta_{13,12}$, and $\Delta_{13,23}$. In Figure 10, each vertex of Φ_3 is labeled by the quadruple of “bounded” minors that appear in the corresponding total positivity criterion.

We suggest the following refinement of Theorem 17.

Conjecture 19. *Every minor of a generic square matrix can be written as a Laurent polynomial with nonnegative integer coefficients in the chamber minors of an arbitrary double wiring diagram.*

Perhaps more important than proving this conjecture would be to give explicit combinatorial expressions for the Laurent polynomials in question. We note a case where the conjecture is true, and the desired expressions can be given: the “lexicographically minimal” double wiring diagram whose chamber minors are the initial minors. Indeed, a generic matrix x can be uniquely written as the product $x_{\mathbf{i}_{\max}}(t_1, \dots, t_{n^2})$ of elementary Jacobi matrices (cf. Theorem 13); then each minor of x can be written as a polynomial in the t_k with nonnegative integer coefficients (with the help of Lindström’s Lemma), while each t_k is a Laurent monomial in the initial minors of x , by Lemma 6.

It is proved in [15, Theorem 1.13] that every minor can be written as a Laurent polynomial with integer (possibly negative) coefficients in the chamber minors of a given diagram. Note, however, that this result, combined with Theorem 17, does not imply Conjecture 19, because there do exist subtraction-free rational expressions that are Laurent polynomials although *not* with nonnegative coefficients (e.g., think of $(p^3 + q^3)/(p + q) = p^2 - pq + q^2$).

The following special case of Conjecture 19 can be derived from [3, Thm. 3.7.4].

Theorem 20. *Conjecture 19 holds for all wiring diagrams in which all intersections of one color precede the intersections of another color.*

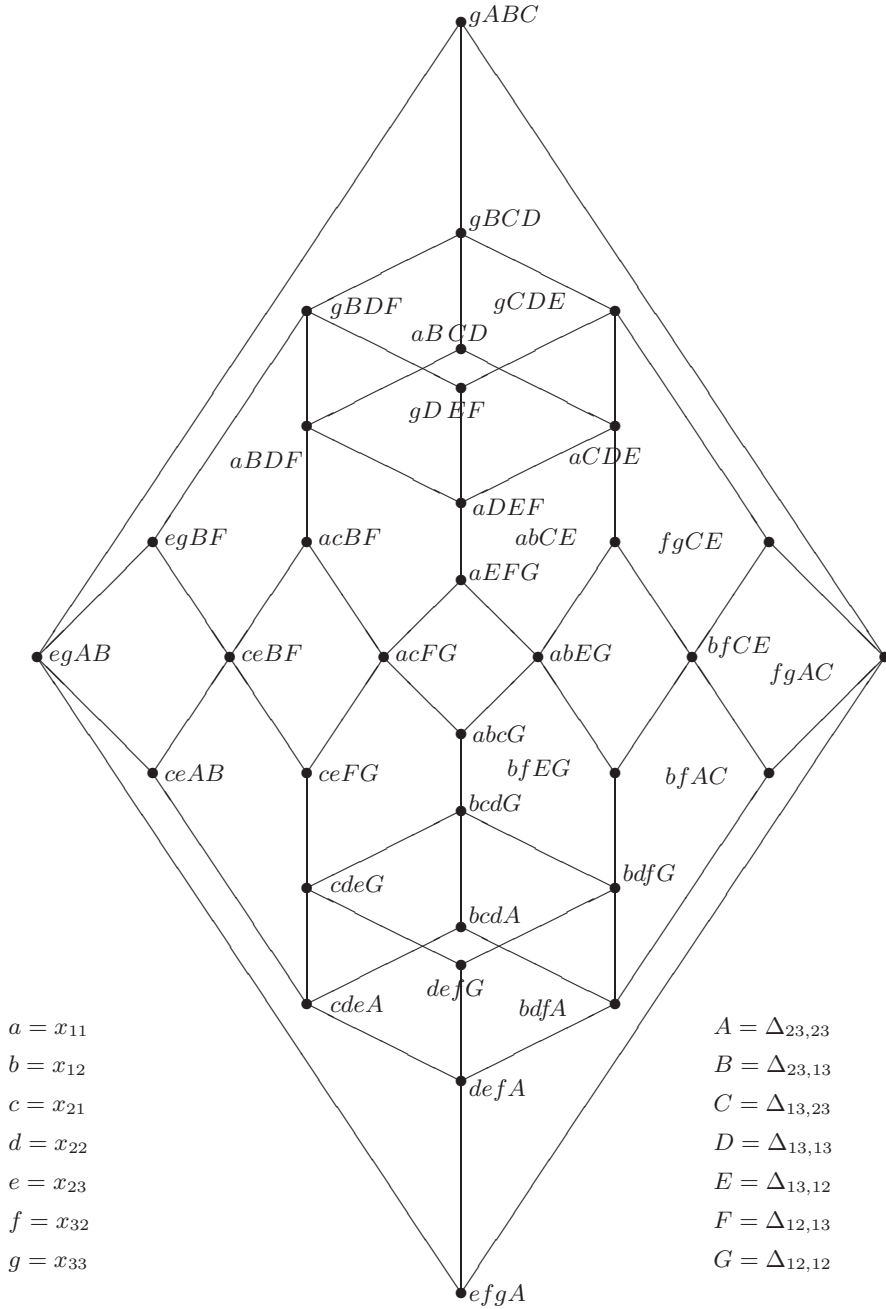

FIGURE 10. Total positivity criteria for GL_3

We do not know an elementary proof of this result; the proof in [3] depends on the theory of canonical bases for quantum general linear groups.

Digression: Somos sequences. The three-term relation $AC + BD = YZ$ is surrounded by some magic that eludes our comprehension. We cannot resist mentioning the related problem involving the *Somos-5 sequences* [19]. (We thank Richard Stanley for telling us about them.) These are the sequences a_1, a_2, \dots in which any 6 consecutive terms satisfy this relation:

$$(6) \quad a_n a_{n+5} = a_{n+1} a_{n+4} + a_{n+2} a_{n+3}.$$

Each term of a Somos-5 sequence is obviously a subtraction-free rational expression in the first 5 terms a_1, \dots, a_5 . More can be shown by extending the arguments in [19, 35]: a_n is actually a Laurent polynomial in a_1, \dots, a_5 . This property is truly remarkable, given the nature of the recurrence, and the fact that, as n grows, these Laurent polynomials become huge sums of monomials involving large coefficients; still, each of these sums cancels out from the denominator of the recurrence relation $a_{n+5} = (a_{n+1} a_{n+4} + a_{n+2} a_{n+3}) / a_n$.

We suggest the following analogue of Conjecture 19.

Conjecture 21. *Every term of a Somos-5 sequence is a Laurent polynomial with nonnegative integer coefficients in the first 5 terms of the sequence.*

FACTORIZATION SCHEMES

According to Theorem 16, every double wiring diagram gives rise to an “optimal” total positivity criterion. We will now show that double wiring diagrams can be used to obtain a family of bijective parametrizations of the set $G_{>0}$ of all totally positive matrices; this family will include as a special case the parametrization in Theorem 13.

We encode a double wiring diagram by the word of length $n(n-1)$ in the alphabet $\{1, \dots, n-1, \bar{1}, \dots, \bar{n-1}\}$ obtained by recording the heights of intersections of pseudolines of like color (traced left to right). For example, the diagram in Figure 6 is encoded by the word $\bar{2} 1 2 \bar{1} \bar{2} 1$.

The words that encode double wiring diagrams have an alternative description in terms of *reduced expressions* in the symmetric group \mathcal{S}_n . Recall that by a famous theorem of E. H. Moore [36], \mathcal{S}_n is a *Coxeter group* of type A_{n-1} , i.e., it is generated by the involutions s_1, \dots, s_{n-1} (adjacent transpositions) subject to the relations $s_i s_j = s_j s_i$ for $|i-j| \geq 2$, and $s_i s_j s_i = s_j s_i s_i$ for $|i-j| = 1$. A *reduced word* for a permutation $w \in \mathcal{S}_n$ is a word $\mathbf{j} = (j_1, \dots, j_l)$ of the shortest possible length $l = \ell(w)$ that satisfies $w = s_{j_1} \cdots s_{j_l}$. The number $\ell(w)$ is called the *length* of w (it is the number of inversions in w). The group \mathcal{S}_n has a unique element w_\circ of maximal length: the order-reversing permutation of $1, \dots, n$.

It is straightforward to verify that the encodings of double wiring diagrams are precisely the shuffles of two reduced words for w_\circ , in the barred and unbarred entries respectively; equivalently, these are the reduced words for the element (w_\circ, w_\circ) of the Coxeter group $\mathcal{S}_n \times \mathcal{S}_n$.

Definition 22. A word \mathbf{i} in the alphabet \mathcal{A} (see (3)) is called a *factorization scheme* if it contains each circled entry \textcircled{i} exactly once, and the remaining entries encode the heights of intersections in a double wiring diagram.

Equivalently, a factorization scheme \mathbf{i} is a shuffle of two reduced words for w_\circ (one barred and one unbarred) and an arbitrary permutation of the entries $\textcircled{1}, \dots, \textcircled{n}$. In particular, \mathbf{i} consists of n^2 entries.

To illustrate, the word $\mathbf{i} = \bar{2} 1 \textcircled{3} 2 \bar{1} \textcircled{1} \bar{2} 1 \textcircled{2}$ appearing in Figure 5 is a factorization scheme.

An important example of a factorization scheme is the word \mathbf{i}_{\max} introduced in Theorem 13. Thus the following result generalizes Theorem 13.

Theorem 23. [15] *For an arbitrary factorization scheme $\mathbf{i} = (i_1, \dots, i_{n^2})$, the product map $x_{\mathbf{i}}$ given by (4) restricts to a bijection between n^2 -tuples of positive real numbers and totally positive $n \times n$ matrices.*

Proof. We have already stated that any two double wiring diagrams are connected by a succession of the local “moves” shown in Figure 9. In the language of factorization schemes, this translates into any two factorization schemes being connected by a sequence of local transformations of the form

$$(7) \quad \begin{aligned} \cdots i j i \cdots &\rightsquigarrow \cdots j i j \cdots, & |i - j| = 1, \\ \cdots \bar{i} \bar{j} \bar{i} \cdots &\rightsquigarrow \cdots \bar{j} \bar{i} \bar{j} \cdots, & |i - j| = 1, \end{aligned}$$

or of the form

$$(8) \quad \cdots a b \cdots \rightsquigarrow \cdots b a \cdots,$$

where (a, b) is any pair of symbols in \mathcal{A} different from $(i, i \pm 1)$ or $(\bar{i}, \overline{i \pm 1})$. (This statement is a special case of Tits’ theorem [45], for the Coxeter group $\mathcal{S}_n \times \mathcal{S}_n \times (\mathcal{S}_2)^n$.)

In view of Theorem 13, it suffices to show that if Theorem 23 holds for some factorization scheme \mathbf{i} , then it also holds for any factorization scheme \mathbf{i}' obtained from \mathbf{i} by one of the transformations (7)–(8). To see this, it is enough to demonstrate that the collections of parameters $\{t_k\}$ and $\{t'_k\}$ in the equality

$$x_{i_1}(t_1) \cdots x_{i_{n^2}}(t_{n^2}) = x_{i'_1}(t'_1) \cdots x_{i'_{n^2}}(t'_{n^2})$$

are related to each other by (invertible) subtraction-free rational transformations. The latter is a direct consequence of the commutation relations between elementary Jacobi matrices, which can be found in [15, Section 2.2 and (4.17)]. The most important of these relations are the following.

First, for $i = 1, \dots, n - 1$ and $j = i + 1$, we have

$$x_i(t_1) x_{\textcircled{2}}(t_2) x_{\textcircled{3}}(t_3) x_{\bar{i}}(t_4) = x_{\bar{i}}(t'_1) x_{\textcircled{2}}(t'_2) x_{\textcircled{3}}(t'_3) x_i(t'_4),$$

where

$$t'_1 = \frac{t_3 t_4}{T}, \quad t'_2 = T, \quad t'_3 = \frac{t_2 t_3}{T}, \quad t'_4 = \frac{t_1 t_3}{T}, \quad T = t_2 + t_1 t_3 t_4.$$

The proof of this relation (which is the only nontrivial relation associated with (8)) amounts to verifying that

$$\begin{bmatrix} 1 & t_1 \\ 0 & 1 \end{bmatrix} \begin{bmatrix} t_2 & 0 \\ 0 & t_3 \end{bmatrix} \begin{bmatrix} 1 & 0 \\ t_4 & 1 \end{bmatrix} = \begin{bmatrix} 1 & 0 \\ t'_1 & 1 \end{bmatrix} \begin{bmatrix} t'_2 & 0 \\ 0 & t'_3 \end{bmatrix} \begin{bmatrix} 1 & t'_4 \\ 0 & 1 \end{bmatrix}.$$

Also, for any i and j such that $|i - j| = 1$, we have the following relation associated with (7):

$$x_i(t_1) x_j(t_2) x_i(t_3) = x_j(t'_1) x_i(t'_2) x_j(t'_3),$$

$$x_{\bar{i}}(t_1) x_{\bar{j}}(t_2) x_{\bar{i}}(t_3) = x_{\bar{j}}(t'_1) x_{\bar{i}}(t'_2) x_{\bar{j}}(t'_3),$$

where

$$t'_1 = \frac{t_2 t_3}{T}, \quad t'_2 = T, \quad t'_3 = \frac{t_1 t_2}{T}, \quad T = t_1 + t_3.$$

One sees that in the commutation relations above, the formulas expressing the t'_k in terms of the t_l are indeed subtraction-free. \square

Theorem 23 suggests an alternative approach to total positivity criteria via the following *factorization problem*: for a given factorization scheme \mathbf{i} , find the genericity conditions on a matrix x assuring that x can be factored as

$$(9) \quad x = x_{\mathbf{i}}(t_1, \dots, t_{n^2}) = x_{i_1}(t_1) \cdots x_{i_{n^2}}(t_{n^2}),$$

and compute explicitly the factorization parameters t_k as functions of x . Then the total positivity of x will be equivalent to the positivity of all these functions. Note that the criterion in Theorem 9 was essentially obtained in this way: for the factorization scheme \mathbf{i}_{\max} , the factorization parameters t_k are Laurent monomials in the initial minors of x (cf. Lemma 6).

A complete solution of the factorization problem for an arbitrary factorization scheme was given in [15, Theorems 1.9 and 4.9]. An interesting (and unexpected) feature of this solution is that in general, the t_k are not Laurent monomials in the minors of x ; the word \mathbf{i}_{\max} is quite exceptional in this respect. It turns out, however, that the t_k are Laurent monomials in the minors of another matrix x' obtained from x by the following birational transformation:

$$(10) \quad x' = [x^T w_o]_+ w_o (x^T)^{-1} w_o [w_o x^T]_-.$$

Here x^T denotes the transpose of x , and w_o is the permutation matrix with 1's on the antidiagonal; finally, $y = [y]_- [y]_0 [y]_+$ denotes the Gaussian (LDU) decomposition of a square matrix y provided such a decomposition exists.

In the special cases $n = 2$ and $n = 3$, the transformation $x \mapsto x'$ is given by

$$x' = \begin{bmatrix} x_{11} x_{12}^{-1} x_{21}^{-1} & x_{21}^{-1} \\ x_{12}^{-1} & x_{22} \det(x)^{-1} \end{bmatrix}$$

and

$$x' = \begin{bmatrix} \frac{x_{11}}{x_{31} x_{13}} & \frac{\Delta_{12,13}}{x_{31} \Delta_{12,23}} & \frac{1}{x_{31}} \\ \frac{\Delta_{13,12}}{x_{13} \Delta_{23,12}} & \frac{x_{33} \Delta_{12,12} - \det(x)}{\Delta_{23,12} \Delta_{12,23}} & \frac{x_{32}}{\Delta_{23,12}} \\ \frac{1}{x_{13}} & \frac{x_{23}}{\Delta_{12,23}} & \frac{\Delta_{23,23}}{\det(x)} \end{bmatrix}.$$

The following theorem provides an alternative explanation for the family of total positivity criteria in Theorem 16.

Theorem 24. [15] *The right-hand side of (10) is well defined for any $x \in G_{>0}$; moreover, the “twist map” $x \mapsto x'$ restricts to a bijection of $G_{>0}$ with itself.*

Let x be a totally positive $n \times n$ matrix, and \mathbf{i} a factorization scheme. Then the parameters t_1, \dots, t_{n^2} appearing in (9) are related by an invertible monomial transformation to the n^2 chamber minors (for the double wiring diagram associated with \mathbf{i}) of the twisted matrix x' given by (10).

In [15], we explicitly describe the monomial transformation in Theorem 24, as well as its inverse, in terms of the combinatorics of the double wiring diagram.

DOUBLE BRUHAT CELLS

Our presentation in this section will be a bit sketchy; details can be found in [15].

Theorem 23 provides a family of bijective (and biregular) parametrizations of the totally positive variety $G_{>0}$ by n^2 -tuples of positive real numbers. The totally nonnegative variety $G_{\geq 0}$ is much more complicated (note that the map in Theorem 14 is surjective but not injective). In this section, we show that $G_{\geq 0}$ splits naturally into “simple pieces” corresponding to pairs of permutations from \mathcal{S}_n .

Theorem 25. [15] *Let $x \in G_{\geq 0}$ be a totally nonnegative matrix. Suppose that a word \mathbf{i} in the alphabet \mathcal{A} is such that x can be factored as $x = x_{\mathbf{i}}(t_1, \dots, t_m)$ with positive t_1, \dots, t_m , and \mathbf{i} has the smallest number of uncircled entries among all words with this property. Then the subword of \mathbf{i} formed by entries from $\{\overline{1}, \dots, \overline{n-1}\}$ (resp. from $\{1, \dots, n-1\}$) is a reduced word for some permutation u (resp. v) in \mathcal{S}_n . Furthermore, the pair (u, v) is uniquely determined by x , i.e., does not depend on the choice of \mathbf{i} .*

In the situation of Theorem 25, we say that x is of type (u, v) . Let $G_{>0}^{u,v} \subset G_{\geq 0}$ denote the subset of all totally nonnegative matrices of type (u, v) ; thus $G_{\geq 0}$ is the disjoint union of these subsets.

Every subvariety $G_{>0}^{u,v}$ has a family of parametrizations similar to those in Theorem 23. Generalizing Definition 22, let us call a word \mathbf{i} in the alphabet \mathcal{A} a *factorization scheme of type (u, v)* if it contains each circled entry \textcircled{i} exactly once, and the barred (resp. unbarred) entries of \mathbf{i} form a reduced word for u (resp. v); in particular, \mathbf{i} is of length $\ell(u) + \ell(v) + n$.

Theorem 26. [15] *For an arbitrary factorization scheme \mathbf{i} of type (u, v) , the product map $x_{\mathbf{i}}$ restricts to a bijection between $(\ell(u) + \ell(v) + n)$ -tuples of positive real numbers and totally nonnegative matrices of type (u, v) .*

Comparing Theorems 26 and 23, we see that

$$(11) \quad G_{>0}^{w_{\circ}, w_{\circ}} = G_{>0},$$

i.e., the totally positive matrices are exactly the totally nonnegative matrices of type (w_{\circ}, w_{\circ}) .

We now show that the splitting of $G_{\geq 0}$ into the union of varieties $G_{>0}^{u,v}$ is closely related to the well-known *Bruhat decompositions* of the general linear group $G = GL_n$. Let B (resp. B_-) denote the subgroup of upper-triangular (resp. lower-triangular) matrices in G . Recall (see, e.g., [1, §4]) that each of the double coset spaces $B \backslash G / B$ and $B_- \backslash G / B_-$ has cardinality $n!$, and one can choose the permutation matrices $w \in \mathcal{S}_n$ as their common representatives. To every two permutations u and v we associate the *double Bruhat cell* $G^{u,v} = BuB \cap B_-vB_-$; thus G is the disjoint union of the double Bruhat cells.

Each set $G^{u,v}$ can be described by equations and inequalities of the form $\Delta(x) = 0$ and/or $\Delta(x) \neq 0$, for some collection of minors Δ . (See [15, Proposition 4.1] or [16].) In particular, the open double Bruhat cell $G^{w_{\circ}, w_{\circ}}$ is given by nonvanishing of all “antiprincipal” minors $\Delta_{[1,i],[n-i+1,n]}(x)$ and $\Delta_{[n-i+1,n],[1,i]}(x)$ for $i = 1, \dots, n-1$.

Theorem 27. [15] *A totally nonnegative matrix is of type (u, v) if and only if it belongs to the double Bruhat cell $G^{u,v}$.*

In view of (11), Theorem 27 provides the following simple test for total positivity of a totally nonnegative matrix.

Corollary 28. [23] *A totally nonnegative matrix x is totally positive if and only if $\Delta_{[1,i],[n-i+1,n]}(x) \neq 0$ and $\Delta_{[n-i+1,n],[1,i]}(x) \neq 0$ for $i = 1, \dots, n$.*

The results obtained above for $G_{>0}^{w_0 \circ w_0} = G_{>0}$ (as well as their proofs) extend to the variety $G_{>0}^{u,v}$ for an arbitrary pair of permutations $u, v \in \mathcal{S}_n$. In particular, the factorization schemes for (u, v) (or rather their uncircled parts) can be visualised by *double wiring diagrams of type (u, v)* in the same way as before, except now any two pseudolines intersect *at most* once, and the lines are permuted “according to u and v .” Every such diagram has $\ell(u) + \ell(v) + n$ chamber minors, and their positivity provides a criterion for a matrix $x \in G^{u,v}$ to belong to $G_{>0}^{u,v}$. The factorization problem and its solution provided by Theorem 24 extend to any double Bruhat cell, with an appropriate modification of the twist map $x \mapsto x'$. The details can be found in [15].

If the double Bruhat cell containing a matrix $x \in G$ is not specified, then testing x for total nonnegativity becomes a much harder problem; in fact, every known criterion involves exponentially many (in n) minors. (See [8] for related complexity results.) The following corollary of a result by Cryer [10] was given by Gasca and Peña [24].

Theorem 29. *An invertible square matrix is totally nonnegative if and only if all its minors occupying several initial rows or several initial columns are nonnegative, and all its leading principal minors are positive.*

This criterion involves $2^{n+1} - n - 2$ minors, which is roughly the square root of the total number of minors. We do not know whether this criterion is optimal.

OSCILLATORY MATRICES

We conclude the paper by discussing the intermediate class of oscillatory matrices that was introduced and intensively studied by Gantmacher and Krein [20, 22]. A matrix is *oscillatory* if it is totally nonnegative while some power of it is totally positive; thus the set of oscillatory matrices contains $G_{>0}$ and is contained in $G_{\geq 0}$. The following theorem provides several equivalent characterizations of oscillatory matrices; the equivalence of (a)-(c) was proved in [22], while the rest of the conditions were given in [17].

Theorem 30. [22, 17] *For an invertible totally nonnegative $n \times n$ matrix x , the following are equivalent:*

- (a) x is oscillatory;
- (b) $x_{i,i+1} > 0$ and $x_{i+1,i} > 0$ for $i = 1, \dots, n-1$;
- (c) x^{n-1} is totally positive;
- (d) x is not block-triangular (cf. Figure 11);
- (e) x can be factored as $x = x_{\mathbf{i}}(t_1, \dots, t_l)$, for positive t_1, \dots, t_l and a word \mathbf{i} that contains every symbol of the form i or \bar{i} at least once;
- (f) x lies in a double Bruhat cell $G^{u,v}$, where both u and v do not fix any set $\{1, \dots, i\}$, for $i = 1, \dots, n-1$.

Proof. Obviously, (c) \implies (a) \implies (d). Let us prove the equivalence of (b), (d), and (e). By Theorem 12, x can be represented as the weight matrix of some planar network $\Gamma(\mathbf{i})$ with positive edge weights. Then (b) means that sink $i+1$ (resp. i)

$$\begin{bmatrix} * & * & 0 & 0 & 0 \\ * & * & 0 & 0 & 0 \\ * & * & * & * & * \\ * & * & * & * & * \\ * & * & * & * & * \end{bmatrix} \quad \begin{bmatrix} * & * & * & * & * \\ * & * & * & * & * \\ 0 & 0 & * & * & * \\ 0 & 0 & * & * & * \\ 0 & 0 & * & * & * \end{bmatrix}$$

FIGURE 11. Block-triangular matrices

can be reached from source i (resp. $i + 1$), for all i ; (d) means that for any i , at least one sink $j > i$ is reachable from a source $h \leq i$, and at least one sink $h \leq i$ is reachable from a source $j > i$; and (e) means that $\Gamma(\mathbf{i})$ contains positively- and negatively-sloped edges connecting any two consecutive levels i and $i + 1$. These three statements are easily seen to be equivalent.

By Theorem 27, (e) \iff (f). It remains to show that (e) \implies (c). In view of Theorem 26 and (11), this can be restated as follows: given any permutation \mathbf{j} of the entries $1, \dots, n-1$, prove that the concatenation \mathbf{j}^{n-1} of $n-1$ copies of \mathbf{j} contains a reduced word for w_\circ . Let \mathbf{j}' denote the subsequence of \mathbf{j}^{n-1} constructed as follows. First, \mathbf{j}' contains all $n-1$ entries of \mathbf{j}^{n-1} which are equal to $n-1$. Second, \mathbf{j}' contains the $n-2$ entries equal to $n-2$ which interlace the $n-1$ entries chosen at the previous step. We then include $n-3$ interlacing entries equal to $n-3$, etc. The resulting word \mathbf{j}' of length $\binom{n}{2}$ will be a reduced word for w_\circ , for it will be equivalent, under the transformations (8), to the lexicographically maximal reduced word $\mathbf{j}_{\max} = (n-1, n-2, n-1, n-3, n-2, n-1, \dots)$. \square

ACKNOWLEDGMENTS

We thank Sara Billey for suggesting a number of editorial improvements. This work was supported in part by NSF grants #DMS-9625511 and #DMS-9700927.

REFERENCES

- [1] J. L. Alperin and R. B. Bell, *Groups and representations*, Springer-Verlag, 1995.
- [2] T. Ando, Totally positive matrices, *Linear Algebra Appl.* **90** (1987), 165–219.
- [3] A. Berenstein, S. Fomin, and A. Zelevinsky, Parametrizations of canonical bases and totally positive matrices, *Adv. Math.* **122** (1996), 49–149.
- [4] A. Berenstein and A. Zelevinsky, Total positivity in Schubert varieties, *Comment. Math. Helv.* **72** (1997), 128–166.
- [5] F. Brenti, The applications of total positivity to combinatorics, and conversely, *in* [25], pp. 451–473.
- [6] F. Brenti, Combinatorics and total positivity, *J. Combin. Theory, Ser. A* **71** (1995), 175–218.
- [7] R. A. Brualdi and H. J. Ryser, *Combinatorial matrix theory*, Encyclopedia of Mathematics and its Applications, vol. 39, Cambridge University Press, Cambridge, 1991.
- [8] A. Cohen, N. Linial, and Yu. Rabinovich, Totally nonnegative matrices and planar arithmetic circuits, preprint.
- [9] C. Cryer, The LU -factorization of totally positive matrices, *Linear Algebra Appl.* **7** (1973), 83–92.
- [10] C. Cryer, Some properties of totally positive matrices, *Linear Algebra Appl.* **15** (1976), 1–25.
- [11] E. Curtis, D. V. Ingerman, and J. Morrow, Circular planar graphs and resistor networks, *Linear Algebra Appl.* **283** (1998), 115–150.
- [12] C. L. Dodgson, *The mathematical pamphlets of Charles Lutwidge Dodgson and related pieces*, F. F. Abeles (Ed.), Lewis Carroll Society of North America, Silver Spring, MD, 1994.
- [13] A. Edrei, On the generating function of totally positive sequences, II, *J. d'Anal. Math* **2** (1952), 104–109.

- [14] M. Fekete, Über ein Problem von Laguerre, *Rendiconti del Circ. Mat. Palermo* **34** (1912), 89–100, 110–120.
- [15] S. Fomin and A. Zelevinsky, Double Bruhat cells and total positivity, *J. Amer. Math. Soc.*, **12** (1999), 335–380.
- [16] S. Fomin and A. Zelevinsky, Recognizing Schubert cells, preprint math.CO/9807079, July 1998.
- [17] S. Fomin and A. Zelevinsky, Totally nonnegative and oscillatory elements in semisimple groups, preprint math.RT/9811100, November 1998.
- [18] W. Fulton and J. Harris, *Representation theory*, Springer-Verlag, New York, 1991.
- [19] D. Gale, Mathematical Entertainments: The Strange and Surprising Saga of the Somos Sequences, *Math. Intelligencer* **13** (1991), no. 1, 40–42.
- [20] F. R. Gantmacher and M. G. Krein, Sur les matrices oscillatoires, *C. R. Acad. Sci. (Paris)* **201** (1935), 577–579.
- [21] F. R. Gantmacher and M. G. Krein, Sur les matrices complètement non négatives et oscillatoires, *Compositio Math.* **4** (1937), 445–476.
- [22] F. R. Gantmacher and M. G. Krein, *Oszillationsmatrizen, Oszillationskerne und Kleine Schwingungen Mechanischer Systeme*, Akademie-Verlag, Berlin, 1960. (Russian edition: Moscow-Leningrad, 1950.)
- [23] M. Gasca and J. M. Peña, Total positivity and Neville elimination, *Linear Algebra Appl.* **165** (1992), 25–44.
- [24] M. Gasca and J. M. Peña, Total positivity, QR factorization, and Neville elimination, *SIAM J. Matrix Anal. Appl.* **14** (1993), 1132–1140.
- [25] *Total positivity and its applications*, M. Gasca and C. A. Micchelli (Eds.), *Mathematics and its Applications* **359**, Kluwer Academic Publishers, Dordrecht, 1996.
- [26] I. Gessel and G. X. Viennot, Binomial determinants, paths, and hooklength formulae, *Adv. in Math.* **58** (1985), 300–321.
- [27] I. Gessel and G. X. Viennot, Determinants, paths, and plane partitions, preprint.
- [28] S. Karlin, *Total positivity*, Stanford University Press, 1968.
- [29] S. Karlin and G. McGregor, Coincidence probabilities, *Pacific J. Math.* **9** (1959), 1141–1164.
- [30] B. Lindström, On the vector representations of induced matroids, *Bull. London Math. Soc.* **5** (1973), 85–90.
- [31] P. Littelmann, Bases canoniques et applications, *Séminaire Bourbaki*, Juin 1998; preprint IRMA-027, Strasbourg, 1998.
- [32] C. Loewner, On totally positive matrices, *Math. Z.* **63** (1955), 338–340.
- [33] G. Lusztig, Total positivity in reductive groups, in: *Lie theory and geometry: in honor of Bertram Kostant*, *Progress in Mathematics* **123**, Birkhäuser, 1994, 531–568.
- [34] G. Lusztig, Introduction to total positivity, in: *Positivity in Lie theory: open problems*, de Gruyter *Exp. Math.* **26**, de Gruyter, Berlin, 1998, 133–145.
- [35] J. L. Malouf, An integer sequence from a rational recursion, *Discrete Math.* **110** (1992), 257–261.
- [36] E. H. Moore, Concerning the abstract groups of order $k!$ and $\frac{1}{2}k!$, *Proc. London Math. Soc.* **28** (1897), 357–366.
- [37] T. Muir, *The theory of determinants*, 2nd edition, vol. 1, Macmillan, London, 1906.
- [38] A. Pinkus, Spectral properties of totally positive kernels and matrices, in [25], pp. 477–511.
- [39] G. Ringel, Teilungen der Ebene durch Geraden oder topologische Geraden, *Math. Z.* **64** (1956), 79–102.
- [40] I. J. Schoenberg, *Selected papers*, vol. 2, Birkhäuser, 1988.
- [41] I. J. Schoenberg, Über Variationsvermindernde lineare Transformationen, *Math. Z.* **32** (1930), 321–328.
- [42] R. P. Stanley, Log-concave and unimodal sequences in Algebra, Combinatorics and Geometry, *Ann. New York Acad. Sci.* **576** (1989), 500–534.
- [43] J. R. Stembridge, Immanants of totally positive matrices are nonnegative, *Bull. London Math. Soc.* **23** (1991), 422–428.
- [44] E. Thoma, Die unzerlegbaren, positiv-definiten Klassenfunktionen der abzählbar unendlichen symmetrischen Gruppe, *Math. Zeit.*, **85** (1964), 40–61.
- [45] J. Tits, Le problème des mots dans les groupes de Coxeter, *Symposia Mathematica (INDAM, Rome, 1967/68)* **1**, 175–185.

- [46] A. M. Whitney, A reduction theorem for totally positive matrices, *J. d'Analyse Math.* **2** (1952), 88–92.

DEPARTMENT OF MATHEMATICS, MASSACHUSETTS INSTITUTE OF TECHNOLOGY, CAMBRIDGE,
MASSACHUSETTS 02139

E-mail address: `fomin@math.mit.edu`

DEPARTMENT OF MATHEMATICS, NORTHEASTERN UNIVERSITY, BOSTON, MA 02115, USA

E-mail address: `andrei@neu.edu`