

# The space of initial conditions for linearisable mappings

T. Takenawa<sup>1</sup>, M. Eguchi<sup>1</sup>, B. Grammaticos<sup>2</sup>, Y. Ohta<sup>3</sup>,  
A. Ramani<sup>4</sup> and J. Satsuma<sup>1</sup>

1: Graduate School of Mathematical Sciences, University of Tokyo,  
Komaba 3-8-1, Meguro-ku, Tokyo 153-8914, Japan

2: GMPiB, Université Paris VII, Tour 24-14, 5<sup>e</sup> étage, case 7021, 75251 Paris, France

3: Department of Applied Mathematics, Faculty of Engineering, Hiroshima University,  
Kagamiyama 1-4-1, Higashi-Hiroshima, 739-8527 Japan

4: CPT, Ecole Polytechnique, CNRS, UMR 7644, 91128 Palaiseau, France

## Abstract

We apply the algebraic-geometric techniques developed for the study of mappings which have the singularity confinement property to mappings which are integrable through linearisation. The main difference with respect to the previous studies is that the linearisable mappings have generically unconfined singularities. Despite this fact we are able to provide a complete description of the dynamics of these mappings and derive rigorously their growth properties.

## 1 Introduction

The study of integrable discrete systems has been pursued with particular intensity over the last decade. The results obtained surpassed expectations: not only does this reputedly difficult domain yield a plethora of new and interesting results but it has also been possible to map in detail the parallels and divergences that exist between integrable discrete systems and their continuous counterparts. As paradigms of integrable discrete systems which were derived and exhaustively studied we must mention here the discrete Painlevé equations, i.e. nonautonomous integrable mappings, the continuous limit of which are the well-known Painlevé equations.

The progress in the domain of discrete integrability was made possible by the development of adequate integrability detectors. The first such detector that has been proposed was singularity confinement. It was based on the observation that for integrable mappings any spontaneously appearing singularity disappears after a few iteration steps. Although singularity confinement was instrumental in the derivation of several new integrable discrete systems, as for example the discrete Painlevé equations[1], it became clear that this property in fact characterises only a restricted class of mappings. The conjecture which we have proposed in [2] can be formulated as follows: mappings integrable through spectral methods have the singularity confinement property. Singularity confinement in itself is not sufficient in order to control the complexity of the iterates of a given mapping. This latter property turned out to be crucial for integrability and thus new integrability detectors were proposed based on this feature. Viallet and collaborators [3, 4] have introduced the notion of algebraic entropy, which is linked to Arnold's complexity [5, 6, 7]. It is defined

as  $S = \lim_{n \rightarrow \infty} \log(d_n)/n$  where  $d_n$  is the degree of the numerator (or denominator) of the  $n$ -th iterate of rational mapping. While nonintegrable mappings exhibit exponential growth and thus nonzero algebraic entropy, integrable ones have zero algebraic entropy, their degree growth being polynomial.

While the detection of integrability is essential, it is by far not sufficient. As Kruskal has always kept pointing out, once an integrable mapping is obtained, one must still perform the complete study of its dynamics. The difficulty lies in the existence of singularities which lead to indeterminate points, i.e. points where the iterates of the mapping is not well defined. Fortunately, for mappings which have the singularity confinement property, only a finite number of such points do exist. In order to deal with these indeterminacies, one must introduce the adequate (local) description of the singularities.

A first step towards this description of integrable discrete systems was undertaken by Sakai [8] who presented a geometric approach to the theory of Painlevé equations based on rational surfaces, which are called spaces of initial conditions [9]. The result was a classification of discrete Painlevé equations in terms of type of rational surfaces and affine Weyl groups.

Further developments in this direction were those introduced by one of the authors (TT), based on the characterisation of mappings from the theory of rational surfaces. In a series of previous works [10, 11, 12] this approach was used for:

- a) mappings which are nonintegrable while having the singularity confinement property. It was possible in that case to obtain rigorously the value of their algebraic entropy.
- b) the mappings of the Sakai classification, for which it was shown that the degree growth is up to quadratic.

Here the same approach will be applied to a different class of integrable mappings: linearisable ones [13, 14]. By linearisable we mean mappings which can be reduced to a local linear difference system. The difficulty in the present case lies in the fact that, generically, linearisable mappings have *unconfined* singularities. Thus one must perform the local study around an infinite number of singularities. Still, due to the particular structure of these systems, this turns out to be possible and allows us to compute precisely their degree growth (which coincides with the one previously obtained empirically). Moreover, the corresponding surfaces provide a straight-forward way to construct transformations of these mappings to linear mappings in cascade.

## 2 Preliminaries

This section is devoted to a review of some basic notions, which we will use later, and the arrangement of notations. In this paper we consider mainly birational mappings, but in order to compare the notions of space of initial conditions and analytical stability [15, 16] we consider dominant rational mappings (i.e. meromorphic mappings such that the closure of each image in the target manifold is the manifold itself) instead of birational mappings in this section.

**Definition.** (degree of rational mapping)

- i)  $\mathbb{P}^2(\mathbb{C})$  case. Let  $\varphi_i: (x, y) \in \mathbb{C}^2 \mapsto (\bar{x}, \bar{y}) \in \mathbb{C}^2$  be a rational mapping for  $i = 0, 1, 2, \dots$ . We can relate a mapping  $\varphi'_i: (X : Y : Z) \in \mathbb{P}^2 \mapsto (\bar{X} : \bar{Y} : \bar{Z}) = (f_i(X, Y, Z) : g_i(X, Y, Z) : h_i(X, Y, Z)) \in \mathbb{P}^2$  to the mapping  $\varphi_i$  by using the relations  $x = X/Z, y = Y/Z$  and  $\bar{x} = \bar{X}/\bar{Z}, \bar{y} = \bar{Y}/\bar{Z}$  and by reducing to a common denominator. The degree of the sequence of mappings is defined by the degree of polynomials.
- ii)  $\mathbb{P}^1(\mathbb{C}) \times \mathbb{P}^1(\mathbb{C})$  case. We denote the degree of a polynomial on  $\mathbb{C} : f(t) = \sum_m a_t t^m$  by

$\deg f(t)$  ( $= \deg_t f(t)$ ). The degree of a rational (=meromorphic) function on  $\mathbb{P}^1$ , which is written as  $P(x) = f(x)/g(x)$  on one of the local coordinates, where  $f(x)$  and  $g(x)$  are polynomials, is defined by

$$\deg(P) = \max\{\deg f(x), \deg g(x)\}.$$

The degree of an irreducible rational function on  $\mathbb{P}^1 \times \mathbb{P}^1$ , which is written as  $P(x, y) = f(x, y)/g(x, y)$  on one of the local coordinates, where  $f(x, y)$  and  $g(x, y)$  are polynomials, is defined by

$$\deg(P) = \deg_x P(x, y) + \deg_y P(x, y).$$

The degree of a mapping  $\varphi : \mathbb{P}^1 \times \mathbb{P}^1 \rightarrow \mathbb{P}^1 \times \mathbb{P}^1$ ,  $(x, y) \mapsto (P(x, y), Q(x, y))$ , where  $P(x, y)$  and  $Q(x, y)$  are rational functions, is defined by

$$\deg(\varphi) = \max\{\deg P(x, y), \deg Q(x, y)\}.$$

### Blowing up

Let  $X$  be a smooth projective surface and let  $p$  be a point on  $X$ . There exists a smooth projective surface  $Z$  and a morphism  $\pi : Z \rightarrow X$  such that  $\pi^{-1}(p) \simeq \mathbb{P}^1$  and  $\pi$  is a biholomorphic mapping from  $Z \setminus \pi^{-1}(p)$  to  $X \setminus p$ . The morphism  $\pi$  is called blow-down and the correspondence  $\pi^{-1}$  is called blow-up of  $X$  at  $p$  as a rational mapping.

Let  $X$  and  $Y$  be smooth projective surfaces and let  $X'$  and  $Y'$  be surfaces obtained by successive blow-ups  $\pi_X^{-1} : X \rightarrow X'$  and  $\pi_Y^{-1} : Y \rightarrow Y'$ . A rational mapping  $\varphi' : X' \rightarrow Y'$  is called *lifted* from a rational mapping  $\varphi : X \rightarrow Y$  if  $\pi_Y \circ \varphi'(x') = \varphi \circ \pi_X(x')$  holds if  $\varphi'(x')$  and  $\varphi \circ \pi_X(x')$  are defined.

**Definition.** (indeterminate set and critical set) Let  $X$  and  $Y$  be smooth projective surfaces and let  $\varphi : X \rightarrow Y$  be a dominant rational mapping. The set of indeterminate points  $\mathcal{I}(\varphi)$  is defined by

$$\mathcal{I}(\varphi) := \{x \in X; \varphi \text{ is indeterminate at } x\}. \quad (1)$$

Let  $\pi^{-1} : X \rightarrow X'$  be a blowing up that eliminates the indeterminacy of  $\varphi$  and let  $\varphi'$  be the mapping lifted from  $\varphi$  (hence both  $\pi$  and  $\varphi'$  are holomorphic). The set of “critical” points  $\mathcal{C}(\varphi)$  is defined by

$$\mathcal{C}(\varphi) := \{y \in Y; \dim(\pi(\varphi'^{-1}(y))) \geq 1\}, \quad (2)$$

where  $\varphi^{-1}(y)$  is considered to be a set correspondence.

### Remark.

- i) The critical set  $\mathcal{C}(\varphi)$  is independent of the choice of  $X'$ .
- ii) If  $\varphi$  is birational, then  $\mathcal{C}(\varphi) = \mathcal{I}(\varphi^{-1})$ .

**Definition.** (space of initial conditions) Let  $Y_i$  be smooth projective surfaces and let  $\{\varphi_i : Y_i \rightarrow Y_{i+1}\}$  be a sequence of dominant rational mappings. A sequence of rational surfaces  $\{X_i\}$  is (or  $X_i$  themselves are) called the space of initial conditions for the sequence of  $\varphi_i$  if each  $\varphi_i$  is lifted to the mapping  $\varphi_i : X_i \rightarrow X_{i+1}$  such that  $\mathcal{I}(\varphi_i) = \mathcal{C}(\varphi_i) = \emptyset$  (an isomorphism, i.e. bi-holomorphic mapping if  $\varphi_i$ 's are birational) [8, 9, 12].

*Picard group*

We denote the group of divisors on a smooth projective surface  $X$  as  $\text{Div}(X)$ . The Picard group of  $X$  is the group of isomorphism classes of invertible sheaves on  $X$  and it is isomorphic to the group of linear equivalence classes of divisors on  $X$ . We denote it by  $\text{Pic}(X)$ .

**Definition.** (pull-back and push-forward action for a surjective morphism) Let  $\varphi : X \rightarrow Y$  be a surjective morphism, where  $X$  and  $Y$  are smooth projective surfaces. The pull-back action  $\varphi^* : \text{Div}(Y) \rightarrow \text{Div}(X)$  is defined naturally as on the Cartier divisors.

Let  $C$  be an irreducible curve (possibly singular) on  $X$ . The push forward action  $\varphi_* : \text{Div}(X) \rightarrow \text{Div}(Y)$  is defined by

$$\varphi_*(C) := \begin{cases} 0 & (\text{if } f(C) \text{ is a point}) \\ \lambda\gamma & (\gamma = f(C) \text{ is an irreducible curve on } Y), \end{cases} \quad (3)$$

where  $\lambda$  is the degree of the covering of  $\varphi|_C : C \rightarrow \gamma$ , and its linear combinations.

**Remark.** Since the action  $\varphi^*$  (or  $\varphi_*$ ) maps the principal divisor on  $Y$  to that of  $X$  (resp. that of  $X$  to that of  $Y$ ), it reduces the homomorphism from  $\text{Pic}(Y)$  to  $\text{Pic}(X)$  (resp. from  $\text{Pic}(X)$  to  $\text{Pic}(Y)$ ) (see Chap. 1 [17] or Prop.1.4 [18]).

**Definition.** (pull-back and push-forward action for a rational mapping) Let  $X$  and  $Y$  be smooth projective surfaces and let  $\varphi : X \rightarrow Y$  be a dominant rational mapping. Let  $X'$  be a surface obtained by successive blow-ups  $\pi^{-1} : X \rightarrow X'$  that eliminates the indeterminacy of  $\varphi$  and let  $\varphi'$  be the mapping lifted from  $\varphi$ . The pull back action  $\varphi^* : \text{Pic}(Y) \rightarrow \text{Pic}(X)$  is defined by

$$\varphi^* := \pi_* \circ \varphi'^* : \text{Div}(Y) \rightarrow \text{Div}(X)$$

and the push-forward action is defined by  $\varphi_* (= (\varphi^{-1})^*$  in the case where  $\varphi$  is birational)

$$\varphi_* := \varphi'_* \circ \pi^* : \text{Div}(X) \rightarrow \text{Div}(Y).$$

**Remark.** These actions are well-defined with respect to choice of  $X'$ .

*Proof.* Let  $\varphi : X \rightarrow Y$  be a dominant rational mapping and let  $X_1$  and  $X_2$  be surfaces obtained by eliminating the indeterminacy of  $\varphi$ . We have the holomorphic mappings  $\pi_i : X_i \rightarrow X$  and  $\varphi_i : X_i \rightarrow Y$ , where  $\varphi_i$ 's are mapping lifted from  $\varphi$ . Moreover there exists a birational mapping  $\psi : X_1 \rightarrow X_2$  such that  $\pi_1 = \pi_2 \circ \psi$ . Hence there exists a smooth projective surface  $\tilde{X}$  and morphisms  $\tilde{\pi}_1 : \tilde{X} \rightarrow X_1$ ,  $\tilde{\pi}_2 : \tilde{X} \rightarrow X_2$  such that  $\tilde{\pi}_2 = \psi \circ \tilde{\pi}_1$ . Let  $D$  be a divisor on  $Y$ . We have

$$\begin{aligned} \pi_{1*} \circ \varphi_1^*(D) &= \pi_{1*} \circ \tilde{\pi}_{1*} \circ \tilde{\pi}_1^* \circ \varphi_1^*(D) \\ &= (\pi_1 \circ \tilde{\pi}_1)_* \circ (\varphi_1 \circ \tilde{\pi}_1)^*(D) \\ &= (\pi_2 \circ \tilde{\pi}_2)_* \circ (\varphi_2 \circ \tilde{\pi}_2)^*(D) \\ &= \pi_{2*} \circ \tilde{\pi}_{2*} \circ \tilde{\pi}_2^* \circ \varphi_2^*(D) \\ &= \pi_{2*} \circ \varphi_2^*(D), \end{aligned}$$

where we use the fact that for any composition of blow-ups  $\pi^{-1} : Z_1 \rightarrow Z_2$  and any divisor  $D \in \text{Div}(Z_1)$ ,  $\pi_* \circ \pi^*(D) = (D)$  holds. □

**PROPOSITION 2.1** *Let  $X, Y$  and  $Z$  be smooth projective surfaces and let  $f : X \rightarrow Y$  and  $g : Y \rightarrow Z$  be a dominant rational mappings. Then for any effective divisor  $D$  on  $Z$*

$$(g \circ f)^*(D) \leq f^* \circ g^*(D)$$

*holds, where the equality holds if and only if  $\mathcal{C}(f) \cap \mathcal{I}(g) = \emptyset$ .*

In our case (smooth projective surfaces' case) this proposition can be proved simply as follows.

*Proof.*

The “only if” part is obvious. Let  $D$  be an irreducible curve such that  $g^{-1}(D) \subset \mathcal{C}(f) \cap \mathcal{I}(g)$ . Then we have  $(g \circ f)^*(D) > 0$  and  $f^* \circ g^*(D) = f^*(0) = 0$ .

Let us prove the “if” part. Without loss of generality we can assume  $D$  is an irreducible curve. There exist irreducible curves  $D_1, D_2, \dots, D_m$ , points  $p_1, p_2, \dots, p_l \subset \mathcal{I}(g)$  and positive integers  $r_1, r_2, \dots, r_m$  such that  $g^{-1}(D) = D_1 + \dots + D_m + p_1 + \dots + p_l$  and  $g^*(D) = r_1 D_1 + r_2 D_2 + \dots + r_m D_m$ . Similarly for each  $D_i$  there exist irreducible curves  $D_{i,1}, D_{i,2}, \dots, D_{i,m_i}$ , points  $p_{i,1}, p_{i,2}, \dots, p_{i,l_i} \subset \mathcal{I}(f)$  and positive integers  $r_{i,1}, r_{i,2}, \dots, r_{i,m_i}$  such that  $g^{-1}(D_i) = D_{i,1} + \dots + D_{i,m_i} + p_{i,1} + \dots + p_{i,l_i}$  and  $g^*(D) = r_{i,1} D_{i,1} + r_{i,2} D_{i,2} + \dots + r_{i,m_i} D_{i,m_i}$ . Hence we have

$$f^* \circ g^*(D) = \sum_{i=1}^m r_i \sum_{j=1}^{m_i} p_{i,j} D_{i,j}.$$

Since  $p_i \notin \mathcal{C}(f)$  and  $g|_{D_i} : D_i \rightarrow D$  is holomorphic,  $(g \circ f)^*(D)$  is the same quantity.  $\square$

**Definition.** (analytical stability [15]) Let each  $X_i$  be a smooth surface and let  $\{\varphi_i : X_i \rightarrow X_{i+1}\}_{i=0,1,2,\dots}$  be a sequence of dominant rational mappings. For a subset  $S \subset X_i$  we denote  $\varphi_i(S \setminus \mathcal{I}(\varphi_i))$  as  $\varphi_i(S)$ . The sequence  $\{\varphi_i\}$  is called analytically stable if

$$\varphi_{n+k-1} \circ \varphi_{n+k-2} \circ \dots \circ \varphi_n(C) \not\subset \mathcal{I}(\varphi_{n+k})$$

for any integers  $n$  and  $k \geq 0$  and any irreducible curve on  $X_n$ , which is equivalent to

$$\varphi_{n+k-1} \circ \varphi_{n+k-2} \circ \dots \circ \varphi_{n+1}(\mathcal{C}(\varphi_n)) \cap \mathcal{I}(\varphi_{n+k}) = \emptyset$$

for any integers  $n$  and  $k \geq 0$ .

The next proposition follows from Prop. 2.1.

**PROPOSITION 2.2** *Let  $\{\varphi_i : X_i \rightarrow X_{i+1}\}_{i=0,1,2,\dots}$  be analytically stable, then*

$$(\varphi_{n+k-1} \circ \varphi_{n+k-2} \circ \dots \circ \varphi_n)^*(D) = \varphi_n^* \circ \varphi_{n+1}^* \circ \dots \circ \varphi_{n+k-1}^*(D)$$

*holds for any divisor  $D$  on  $X_{n+k}$ .*

*Total transform and proper transform*

Let  $\pi^{-1} : X \rightarrow Y$  be the blow-up at the point  $p$  and let  $D$  be a divisor on  $X$ . The divisor  $\pi^*(D)$  on  $Y$  is called the total transform of  $D$ . Let  $V$  be an analytic subvariety of  $X$ . The closure of the set  $\pi^{-1}(V \setminus p)$  in  $Y$  is called the proper transform of  $V$ . The divisor  $\pi^{-1}(p)$  is also called the total transform of the point  $p$ .

*Strategy to obtain the space of initial conditions*

Our strategy to obtain the space of initial conditions for a sequence of rational mapping is as follows. Let  $F(= Y_{0,i}$ , independent of  $i$ ) be a minimal surface and let each  $\varphi_i : Y_{0,i} \rightarrow Y_{0,i+1}$  be a rational mapping. First blowing up  $Y_{0,i}$  at the points in  $\mathcal{I}(\varphi_i) \cup \mathcal{C}(\varphi_{i-1})$ , we have the surfaces  $Y_{1,i}$  such that each  $\varphi_i$  can be lifted to a rational holomorphic mapping from  $Y_{1,i}$  to  $Y_{0,i+1}$  and  $\varphi_{i-1}$  can be lifted to a rational mapping from  $Y_{0,i-1}$  to  $Y_{1,i}$  such that  $\mathcal{C}(\varphi_{i-1}) = \emptyset$ . The mapping  $\varphi_i$  can also be lifted to a rational mapping from  $Y_{1,i}$  to  $Y_{1,i+1}$ . Next by blowing up  $Y_{1,i}$  at the points in  $\mathcal{I}(\varphi_i) \cup \mathcal{C}(\varphi_{i-1})$  similarly,  $\varphi_i$  is lifted to a rational mapping from  $Y_{2,i}$  to  $Y_{2,i+1}$ .

If we have  $Y_{n,i} = Y_{n+1,i}$  for all  $i$  for some  $n$  by continuing this operation, then each  $\varphi_i$  is lifted to a biregular mapping, i.e. an isomorphism, from  $Y_{n,i}$  to  $Y_{n,i+1}$  and hence the sequence of  $X_i := Y_{n,i}$  can be considered to be the space of initial conditions. Of course this procedure does not terminate for general birational mappings and we may need not only blow-ups but also blow-downs for some mappings.

*Strategy to obtain a sequence of analytically stable mappings*

Our strategy to obtain a sequence of surfaces such that  $\{\varphi_i\}$  is lifted to an analytically stable system is as follows. Let  $F(= Y_{0,i})$  be a minimal surface and let each  $\varphi_i : Y_{0,i} \rightarrow Y_{0,i+1}$  be a rational mapping. First blowing up  $Y_{0,i}$  at the points in

$$\bigcup_{j=-\infty}^{i-1} \varphi_{i-1} \circ \varphi_{i-2} \circ \cdots \circ \varphi_{j+1}(\mathcal{C}(\varphi_j)) \cap \mathcal{I}(\varphi_i), \quad (4)$$

we have the surfaces  $Y_{1,i}$  such that  $\{\varphi_i\}$  can be lifted to a sequence of rational mappings  $\{\cdots \rightarrow Y_{0,i-1} \rightarrow Y_{1,i} \rightarrow Y_{0,i+1}\}$  such that (4) =  $\emptyset$ . Next blowing up  $Y_{1,i}$  at the points in (4) for  $\{\varphi_i : Y_{1,i} \rightarrow Y_{1,i+1}\}$ , we have the surfaces  $Y_{2,i}$  such that  $\{\varphi_i\}$  can be lifted to a sequence of rational mappings  $\{\cdots \rightarrow Y_{2,i-1} \rightarrow Y_{2,i} \rightarrow Y_{1,i+1}\}$  such that (4) =  $\emptyset$ . If we have  $Y_{n,i} = Y_{n+1,i}$  for all  $i$  for some  $n$  by continuing this operation, then  $\{\varphi_i\}$  is lifted to an analytically stable sequence of mappings  $\{\varphi_i : Y_{n,i} \rightarrow Y_{n,i+1}\}$ . This procedure does not terminate for general sequence of rational mappings but it always terminates for autonomous systems.

*Picard group of rational surface*

Let  $\pi^{-1} : X \rightarrow Y$  be the blow-up at the point  $p$ . Let  $C$  be a curve on  $X$ . The linear equivalence class of the total transform of  $C$  is written as  $(\pi^{-1})^*[C]$  or simply as  $[C]$ . If the point  $p$  is an element of  $C$ , the linear equivalence class of the proper transform is  $[C] - m[p]$ , where  $m$  is the multiplicity of  $C$  at  $p$ .

Let  $X$  be a surface obtained by  $L$  times blowing up  $\mathbb{P}^2$ . The Picard group  $\text{Pic}(X)$  is isomorphic to a  $\mathbb{Z}$ -module in the form

$$\mathbb{Z}E + \sum_{l=1}^L \mathbb{Z}E_l,$$

where  $E$  denotes the linear equivalence class of the total transform of a generic line in  $\mathbb{P}^2$  and  $E_l$  denotes that of the point of the  $l$ th blow up.

Let  $X$  be a surface obtained by  $L$  times blowing up  $\mathbb{P}^1 \times \mathbb{P}^1$ . The Picard group  $\text{Pic}(X)$ , is isomorphic to a  $\mathbb{Z}$ -module in the form

$$\mathbb{Z}H_0 + \mathbb{Z}H_1 + \sum_{l=1}^L \mathbb{Z}E_l,$$

where  $H_0$  (or  $H_1$ ) denotes the linear equivalence class of the total transform of the line  $x = \text{constant}$  (resp.  $y = \text{constant}$ ).

*Intersection numbers*

Let  $X$  be a surface obtained by blow-ups from  $\mathbb{P}^2$ . The intersection number of any two divisors on  $X$  is given by the following intersection form and their linear combinations,

$$E \cdot E = 1, \quad E \cdot E_l = 0, \quad E_l \cdot E_m = -\delta_{l,m}, \quad (5)$$

where  $\delta_{l,m}$  is 1 if  $l = m$  and 0 if  $l \neq m$ .

In  $\mathbb{P}^1 \times \mathbb{P}^1$  case the intersection form is

$$H_i \cdot H_j = 1 - \delta_{i,j}, \quad E_l \cdot E_m = -\delta_{l,m}, \quad H_i \cdot E_l = 0. \quad (6)$$

**LEMMA 2.3** *Let  $X$  and  $Y$  be rational surfaces obtained by blow-ups from  $\mathbb{P}^2$  or  $\mathbb{P}^1 \times \mathbb{P}^1$ . If  $\varphi : X \rightarrow Y$  is a rational mapping, the following formulae hold, in the  $\mathbb{P}^2$  case*

$$\text{deg}(\varphi) = (\varphi)^*(E) \cdot E$$

and in the  $\mathbb{P}^1 \times \mathbb{P}^1$  case

$$\begin{aligned} \text{deg}_x(P) &= (\varphi)^*(H_0) \cdot H_1 & \text{deg}_y(P) &= (\varphi)^*(H_0) \cdot H_0 \\ \text{deg}_x(Q) &= (\varphi)^*(H_1) \cdot H_1 & \text{deg}_y(Q) &= (\varphi)^*(H_1) \cdot H_0, \end{aligned}$$

where  $\varphi$  is written as  $\varphi(x, y) = (P(x, y), Q(x, y))$  in one of the local coordinates.

*Proof.* Let  $X'$  be a surface obtained by successive blow-ups  $\pi^{-1} : X \rightarrow X'$  that eliminate the indeterminacy of  $\varphi$  and let  $\varphi'$  be the mapping lifted from  $\varphi$ . These formulae hold for  $\varphi'$  (see [11]). The coefficients of  $E, H_0$  and  $H_1$  on  $X$  and on  $X'$  are the same and hence these formulae also hold for  $\varphi$ . □

The next proposition follows from Prop.2.2 and Lemma,2.3.

**PROPOSITION 2.4** *Let  $X_i$  be rational surfaces obtained by blow-ups from  $\mathbb{P}^2$  or  $\mathbb{P}^1 \times \mathbb{P}^1$  and let  $\{\varphi_i : X_i \rightarrow X_{i+1}\}$  be a sequence of rational mappings, then the following formulae hold, in the  $\mathbb{P}^2$  case*

$$\begin{aligned} \text{deg}(\varphi^n) &= (\varphi^n)^*(E) \cdot E = \prod_{i=0}^{n-1} \varphi_i^*(E) \cdot E \\ & (= \text{deg}(\varphi^{-n}) = (\varphi^n)_*(E) \cdot E, \text{ if } \varphi \text{ is birational}) \end{aligned}$$

where  $\varphi^n$  denotes  $(\varphi_{n-1} \circ \dots \circ \varphi_1 \circ \varphi_0)$  and in the  $\mathbb{P}^1 \times \mathbb{P}^1$  case

$$\begin{aligned} \text{deg}_x P^n(x, y) &= (\varphi^n)^*(H_0) \cdot H_1 = (\varphi^n)_*(H_1) \cdot H_0 \\ \text{deg}_y P^n(x, y) &= (\varphi^n)^*(H_0) \cdot H_0 = (\varphi^n)_*(H_0) \cdot H_0 \\ \text{deg}_x Q^n(x, y) &= (\varphi^n)^*(H_1) \cdot H_1 = (\varphi^n)_*(H_0) \cdot H_0 \\ \text{deg}_y Q^n(x, y) &= (\varphi^n)^*(H_1) \cdot H_0 = (\varphi^n)_*(H_0) \cdot H_1. \end{aligned}$$

where  $P^n(x, y)$  and  $Q^n(x, y)$  denote  $\varphi^n(x, y) = (P^n(x, y), Q^n(x, y))$  in one of the local coordinates and the later equalities hold if  $\varphi$  is birational.

We conclude this section by introducing a theorem proposed by Diller and Favre [16] which is closely related to our problem.

**PROPOSITION 2.5** *Let  $X$  be a Kähler surface and let  $\varphi$  be a birational automorphism of  $X$  such that the degree grows linearly in  $n$ , then there exists a ruled surface  $Y$  such that*

- i)  $\varphi_i$  is birationally conjugate to a birational automorphism of  $Y$ .
- ii) there exists a unique class  $L$  in  $\text{Pic}(Y)$  which is preserved by  $\varphi_i^*$ .  $L \cdot L = 0$  and  $L$  is a class of generic fibers which is preserved by  $\varphi_i$ .

### 3 A Projective mapping

**Definition.** (confining singularity pattern) Let  $X_i$ 's be smooth projective surfaces and  $\{\varphi_i : X_i \rightarrow X_{i+1}\}$  be a sequence of rational mappings. Some effective divisor topologically may appear or disappear for some of these mappings and we call these sequences singularity patterns. Singularity patterns can be classified as follows, (EF means effective divisor)

- i)  $\cdots \rightarrow \text{EF} \rightarrow \text{EF} \rightarrow \text{point} \rightarrow \cdots \rightarrow \text{point} \rightarrow \text{EF} \rightarrow \text{EF} \rightarrow \cdots$ : *strictly confining*,
- ii)  $\cdots \rightarrow \text{point} \rightarrow \text{point} \rightarrow \text{EF} \rightarrow \cdots \rightarrow \text{EF} \rightarrow \text{point} \rightarrow \text{point} \rightarrow \cdots$ : *confining* (but not strictly confining),
- iii) othwise: *non-confining*.

In this section we consider a mapping which is confining but not strictly confining and whose degree is constant with respect to the iteration. We shall illustrate how to use the method of space of initial conditions in this case. It turns out that the corresponding space of initial conditions needs an infinite number of blow-ups, or sometimes blow-downs, but still has a meaning.

Let us consider the following simple non-autonomous discrete dynamical system:

$$x_{n+1} = -a_n - \frac{b_n}{x_n} - \frac{1}{x_n x_{n-1}} \quad (7)$$

where  $a_n$  and  $b_n$  are free functions of  $n \in \mathbb{Z}$ . This equation is equivalent to the following 2-dimensional mapping  $\varphi_n : (x, y) \in \mathbb{C}^2 \mapsto (\bar{x}, \bar{y}) \in \mathbb{C}^2$ :

$$\varphi_n : \begin{cases} \bar{x} = y \\ \bar{y} = (-a_n x y - b_n x - 1)/x y \end{cases} \quad (8)$$

where  $(\bar{x}, \bar{y})$  means the image of  $(x, y)$  by  $\varphi_n$ .

Let us consider  $\varphi_n$  to be a mapping from the complex projective space  $\mathbb{P}^1 \times \mathbb{P}^1$  to itself. We take a coordinate system of  $\mathbb{P}^1 \times \mathbb{P}^1$  as  $U_1(x, y), U_2(x, Y), U_3(X, y), U_4(X, Y)$  where  $X = 1/x, Y = 1/y$  and  $U_i \cong \mathbb{C}^2$ . In these coordinates  $\varphi_n$  is written as follows (for simplicity we write  $\bar{y}$  only)

$$\bar{y} = \begin{cases} (-a_n x y - b_n x - 1)/x y & \text{from } U_1 \\ (-a_n x - b_n x Y - Y)/x & \text{from } U_2 \\ (-a_n y - b_n - X)/y & \text{from } U_3 \\ -a_n - b_n Y - X Y & \text{from } U_4 \end{cases} \quad (9)$$

From Eq.(9) we can find the indeterminate points of  $\varphi_n$  (the points where  $\bar{y} \in \mathbb{P}^1$  is indeterminate):  $(x, y) = (-1/b_n, 0)$  and  $(0, \infty)$ .



### 3.1 Space of initial conditions (by blow-ups)

*Blow-up of a rational surface*

We denote the blow-up at  $(x, y) = (x_0, y_0) \in \mathbb{C}^2$ :

$$\begin{aligned} & \{(x, y) : x, y \in \mathbb{C}\} \\ \xleftarrow{\mu(x_0, y_0)} & \{(x - x_0, y - y_0; \zeta_1 : \zeta_2) \mid x, y, \zeta_1, \zeta_2 \in \mathbb{C}, \\ & |\zeta_1| + |\zeta_2| \neq 0, (x - x_0)\zeta_2 = (y - y_0)\zeta_1\} \end{aligned}$$

by

$$(x, y) \leftarrow (u, v) = (x - x_0, \frac{y - y_0}{x - x_0}) \cup (u', v') = (\frac{x - x_0}{y - y_0}, y - y_0). \quad (10)$$

First we blow up at  $(x, Y) = (0, 0)$ ,  $(x, Y) \leftarrow (x, Y/x) \cup (x/Y, Y)$  and denote the obtained surface by  $Y'_n$ . Then  $\varphi_n$  is lifted to a birational mapping from  $Y'_n$  to  $\mathbb{P}^1 \times \mathbb{P}^1$ . For example, in the new coordinates  $\varphi_n$  is expressed as

$$\begin{aligned} (u_E, v_E) &:= (x, Y/x) \mapsto (\bar{x}, \bar{y}) = (1/u_E v_E, -a_n - b_n u_E v_E - v_E) \\ (u'_E, v'_E) &:= (x/Y, Y) \mapsto (\bar{x}, \bar{y}) = (1/v'_E, (-a_n u'_E - b_n u'_E v'_E - 1)/u'_E) \end{aligned}$$

(use (8) and the definition of  $u_E, v_E, u'_E$  and  $v'_E$ ). The exceptional curve is described as  $u_E = 0$  (or  $v'_E = 0$ ) and its image is described as  $(\bar{X}, \bar{y}) = (0, -a_n - v_E)$  ( $\bar{X} = 1/\bar{x}$ ). In this way, blowing up at  $(x, y) = (x_0, y_0)$  gives meaning to  $(x - x_0)/(y - y_0)$  at this point.

The indeterminate points of the inverse mapping  $\varphi_{n-1}^{-1}$ :

$$\varphi_{n-1}^{-1} : \begin{cases} \underline{x} &= -1/(xy + a_{n-1}x + b_{n-1}) \\ \underline{y} &= x \end{cases}, \quad (11)$$

are  $(x, y) = (\infty, -a_{n-1})$  and  $(0, \infty)$ , where  $(\underline{x}, \underline{y})$  means the image of  $(x, y)$  by  $\varphi_{n-1}^{-1}$ . By successive blow-ups we can eliminate the indeterminacy of  $\varphi_n$  and  $\varphi_{n-1}^{-1}$  and we obtain the surface  $Y_{1,n}$  defined by the following sequence of blow-ups (for simplicity we write only one of the coordinates of (10)):

$$\begin{aligned} (x, y) &\xleftarrow[\mu_E]{(0, \infty)} (u_E, v_E) = \left(x, \frac{1}{xy}\right) \\ (x, y) &\xleftarrow[\mu_{F_1}]{(-\frac{1}{b_n}, 0)} (u_{F_1}, v_{F_1}) = \left(x + \frac{1}{b_n}, \frac{y}{x + 1/b_n}\right) \\ (x, y) &\xleftarrow[\mu_{G_1}]{(\infty, -a_{n-1})} (u_{G_1}, v_{G_1}) = \left(\frac{1}{x}, x(y + a_{n-1})\right). \end{aligned}$$

and  $\varphi_n$  (and  $\varphi_{n-1}^{-1}$ ) is lifted to a regular mapping from  $Y_{1,n}$  to  $\mathbb{P}^1 \times \mathbb{P}^1$ .

Following the scheme of the previous section, we successively blow up at the points each of which is the image or the pre-image of some curve. We assume the points  $\varphi_{k-i}^{-1} \circ \varphi_{k-2}^{-1} \circ \dots \circ \varphi_{k-1}^{-1}(-\frac{1}{b_k}, 0)$  or  $\varphi_{k+i} \circ \varphi_{k+2} \circ \dots \circ \varphi_{k+1}(\infty, -a_k)$  do not meet the lines  $x = 0, x = \infty, y = 0, y = \infty$  for any integers  $k$  and  $i \leq 1$ . For generic  $\{a_n\}$  and  $\{b_n\}$  this is true. Blowing-up at these points, we obtain the sequence of ‘‘rational surfaces’’  $\{X_n := Y_{\infty, n}\}$ . (See Fig.1).

We denote the class of the total transform of the line  $x = \text{constant}$  or  $y = \text{constant}$  as  $H_0$  and  $H_1$  respectively and denote the class of the total transform of the points

$(0, \infty)$ ,  $\varphi_{k-i}^{-1} \circ \varphi_{k-2}^{-1} \circ \cdots \circ \varphi_{k-1}^{-1}(-\frac{1}{b_k}, 0)$  or  $\varphi_{k+i} \circ \varphi_{k+2} \circ \cdots \circ \varphi_{k+1}(\infty, -a_k)$  ( $i = 0, 1, 2, \dots$ ) as  $E, F_i$  or  $G_i$  respectively. In Fig.1 each line means an irreducible curve and the intersection of lines means the intersection of corresponding curves. For example the class of total transform of the line  $x = 0$  is  $H_0$  and the class of its proper transform is  $H_0 - E$  (see “Picard group of rational surfaces” in Section 2).

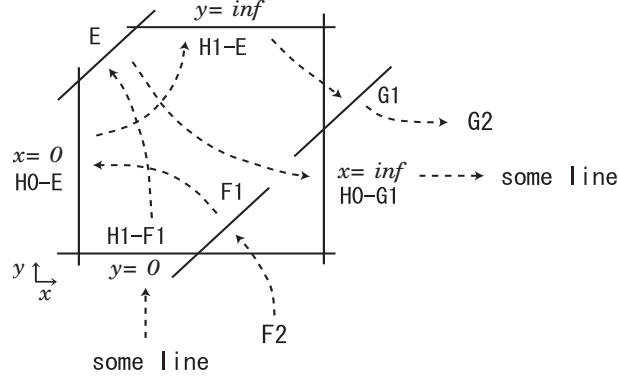

Figure 1: Sect.3.1

**Remark.** Of course the surface  $X_n$  is defined by infinite times blowing up and therefore is not a rational surface, but we can justify our discussion through the arguments below. We denote the blow-ups of  $E, F_i$  and  $G_i$  as  $\mu_E, \mu_{F_i}$  and  $\mu_{G_i}$  respectively. Let  $N$  be a sufficiently large positive integer and let  $k$  be an integer such that  $|k| < N$ . Let  $X_{k,n}$  be a rational surface obtained by blow-ups  $\mu_E, \mu_{F_1}, \mu_{F_2}, \dots, \mu_{F_{N-k}}$  and  $\mu_{G_1}, \mu_{F_2}, \dots, \mu_{G_{N+k}}$ . Then  $\varphi_n$  is lifted to an isomorphism from  $X_{k,n}$  to  $X_{k-1,n+1}$ .

*Actions on the Picard group*

The Picard group of  $X_n$  is isomorphic to the lattice

$$\mathbb{Z}H_0 + \mathbb{Z}H_1 + \mathbb{Z}E + \sum_{i=1}^{\infty} \mathbb{Z}F_i + \sum_{i=1}^{\infty} \mathbb{Z}G_i.$$

The mapping  $\varphi_n$  maps  $\text{Pic}(X_n)$  to  $\text{Pic}(X_{n+1})$  as

$$\begin{aligned} H_1 &\mapsto H_0 \quad (\text{if } y \text{ is a constant, then } \bar{x} \text{ is a constant}) \\ H_1 - E &\mapsto G_1 \\ H_0 - E &\mapsto H_1 - E \\ E &\mapsto H_0 - G_1 \\ F_1 &\mapsto H_0 - E \\ H_1 - F_1 &\mapsto E \\ F_i &\mapsto F_{i-1} \quad (\text{for } i \geq 2) \\ G_i &\mapsto G_{i+1} \end{aligned}$$

and hence the linear transformation  $(\varphi_n)_* : \text{Pic}(X_n) \rightarrow \text{Pic}(X_{n+1})$  is

$$\begin{aligned} H_0 &\mapsto H_0 + H_1 - E - G_1 \\ H_1 &\mapsto H_0 \end{aligned}$$

$$\begin{aligned}
E &\mapsto H_0 - G_1 \\
F_1 &\mapsto H_0 - E \\
F_i &\mapsto F_{i-1} \quad (\text{for } i \geq 2) \\
G_i &\mapsto G_{i+1}.
\end{aligned}$$

By using Prop. 2.4 and

$$\begin{aligned}
\left( \prod_{k=0}^{m-1} (\varphi_{n+k}) \right)_* (H_0) &= H_0 + H_1 - E - G_m \\
(\varphi_{n+k})_*(H_1) &= H_0,
\end{aligned}$$

the degree of  $(\prod_{k=0}^{m-1} \varphi_{n+k})(x, y) = (P^m, Q^m)$ ,  $(m \geq 1)$ , can be calculated as

$$\begin{aligned}
\deg_x P_m &= 1 \quad (\text{if } m \geq 2), \quad 0 \quad (\text{if } m = 1), \\
\deg_y P_m &= \deg_x Q_m = \deg_y Q_m = 1.
\end{aligned}$$

### 3.2 Space of initial conditions (by blow-ups and blow-downs)

From Fig.1 we can find the fact that  $\varphi_n$  is lifted to an automorphism on the surface obtained by the blow-up  $\mu_E$  and blow-downs along the proper transforms of the lines  $x = 0$  and  $y = 0$ . This surface is nothing but  $\mathbb{P}^2$  (see Fig.2).

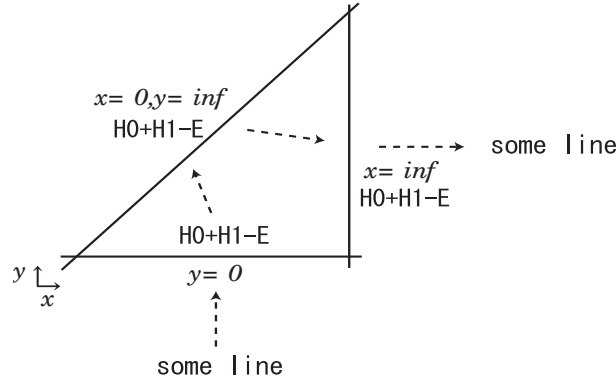

Figure 2: Sect.3.2

The concrete calculation is as follows.

$$\begin{aligned}
&(x, y) \cup (x, \frac{1}{y}) \cup (\frac{1}{x}, y) \cup (\frac{1}{x}, \frac{1}{y}) = \mathbb{P}^1 \times \mathbb{P}^1 \\
\leftarrow &(x, y) \cup (x, \frac{1}{xy}) \cup (xy, \frac{1}{y}) \cup (\frac{1}{x}, y) \cup (\frac{1}{x}, \frac{1}{y}) \\
\rightarrow &(x, xy) \cup (x, \frac{1}{xy}) \cup (\frac{1}{x}, y) \cup (\frac{1}{x}, \frac{1}{y}) \\
\rightarrow &(x, xy) \cup (\frac{1}{x}, y) \cup (\frac{1}{y}, \frac{1}{xy}) \\
= &(x, z) \cup (\frac{1}{x}, y) \cup (\frac{1}{y}, \frac{1}{z}) = \mathbb{P}^2 \quad (z = xy).
\end{aligned}$$

By putting  $x = v/u, y = w/v, z = w/u$ ,  $\varphi_n$  reduces to the mapping from  $\mathbb{P}^2$  to itself:

$$(\bar{u} : \bar{v} : \bar{w}) = (v : w : -a_n w - b_n v - u) \quad (12)$$

and therefore  $\varphi_n$  has been reduced to a linear transformation on  $\mathbb{P}^2$ .

**Remark.** The singularity pattern of  $\{\varphi_n : \mathbb{P}^1 \times \mathbb{P}^1 \rightarrow \mathbb{P}^1 \times \mathbb{P}^1\}$  corresponding to  $F_i$  and  $G_i$  is  $\{\dots, \text{point}, \text{point}, \text{line}, \text{line}, \text{point}, \text{point}, \dots\}$ . In these case there is a possibility that the lines can be blown down (but not always, see Section 3 and 4).

### 3.3 Analytically stable surface

Following the scheme in Section 2 we can obtain a surface such that  $\{\varphi_n\}$  is analytically stable. Recall that a sequence of mappings  $\{\psi_i : X_i \rightarrow X_{i+1}\}$  is analytically stable if and only if there does not exist a singularity pattern [EF  $\rightarrow$  point  $\rightarrow \dots \rightarrow$  point  $\rightarrow$  EF], where EF means effective divisor, and hence we can obtain such a sequence surfaces by blowing up at all the points in these singularity patterns of  $\{\varphi_n : \mathbb{P}^1 \times \mathbb{P}^1 \rightarrow \mathbb{P}^1 \times \mathbb{P}^1\}$ . Let  $X$  be the surface obtained by the blow-up  $\mu_E$ , then  $\{\varphi_n : X \rightarrow X\}$  is analytically stable. In fact, since  $\mathcal{I}(\varphi_n) = \{(-1/b_n, 0)\}$  and  $\mathcal{C}(\varphi_m) = \{(\infty, -b_m)\}$  we have  $\mathcal{I}(\varphi_n) \cap (\prod_{k=1}^{n-m-1} \varphi_{m+k})(\mathcal{C}(\varphi_m)) = \emptyset$  (we have assumed that  $a_n$  and  $b_n$  are generic)(see Fig.3).

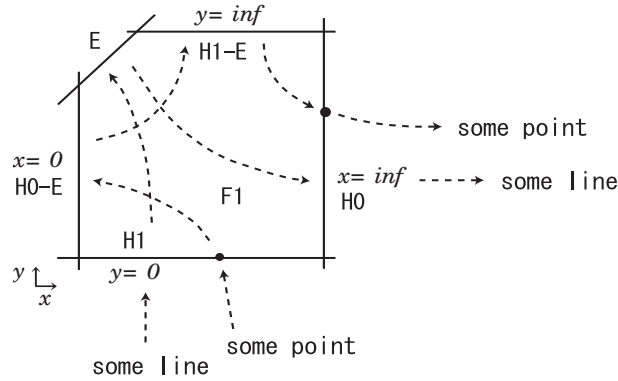

Figure 3: Sect.3.3

The action  $(\varphi_n)_*$  on  $\text{Pic}(X)$  is

$$\begin{aligned} H_0 &\mapsto H_0 + H_1 - E \\ H_1 &\mapsto H_0 \\ E &\mapsto H_0. \end{aligned}$$

## 4 A simple Riccati system

In this section and the next one we consider some mappings which are non-confining but whose degrees grow linearly with the iteration of these mappings. These systems can be linearised to “Riccati” systems as explained in [14]. We shall show that this linearisation can be recovered in a straightforward way by using the method of the space of initial conditions.

In this section let us consider the following simple non-autonomous discrete dynamical system:

$$x_{n+1} = \left(-\frac{x_n}{x_{n-1}} + a_n\right)x_n \quad (13)$$

This mapping is linearised in a straightforward way, since it can be written as

$$w_n = -w_{n-1} + a_n, \quad x_{n+1} = x_n w_n$$

by putting  $w_n = x_{n+1}/x_n$ . This system can be solved in cascade (the former equation is linear (projective in general) and the later one is linear (resp. projective) with respect to  $x_n$ ). We will recover this transformation by using the space of initial conditions.

Eq. (13) reduces to the mapping  $\varphi_n : \mathbb{P}^1 \times \mathbb{P}^1 \rightarrow \mathbb{P}^1 \times \mathbb{P}^1$ :

$$\begin{cases} \bar{x} = y \\ \bar{y} = \left(-\frac{y}{x} + a_n\right)y \end{cases} \quad (14)$$

and the indeterminate points of  $\varphi_n$  and  $\varphi_{n-1}^{-1}$  are  $(x, y) = (0, 0)$  and  $(\infty, \infty)$ .

#### 4.1 Space of initial conditions

In the same way as in Section 3.1 we obtain the sequence of “rational surfaces”  $X_n$  as Fig.4.

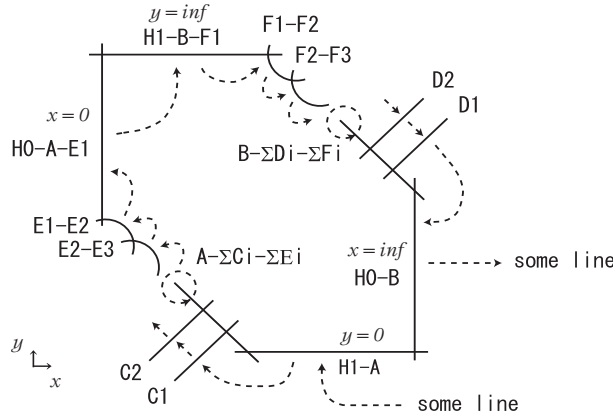

Figure 4: Sect.4.1

In the surface  $X_n$  the total transforms of the points of blow-ups are as follows:

$$\begin{aligned} A &: (x, y) = (0, 0) \\ B &: (1/x, 1/y) := (0, 0) \\ C_i &: (u_A, v_A) := (x, y/x) = \left(0, \sum_{k=1}^i a_{n-i-1}\right) \\ D_i &: (u_B, v_B) := (y/x, 1/y) = \left(-\sum_{k=0}^{i-1} a_{n+i}, 0\right) \\ E_1 &: (u'_A, v'_A) := (x/y, y) = (0, 0) \end{aligned}$$

$$\begin{aligned}
E_2 : (u_{E_1}, v_{E_1}) &:= (u'_A, v'_A/u'_A) = (0, 0) \\
E_{i+1} : (u_{E_i}, v_{E_i}) &:= (u_{E_{i-1}}, v_{E_{i-1}}/u_{E_{i-1}}) = (0, 0) \quad (i \geq 2) \\
F_1 : (u'_B, v'_B) &:= (1/x, x/y) = (0, 0) \\
F_2 : (u_{F_1}, v_{F_1}) &:= (u'_B/v'_B, v'_B) = (0, 0) \\
F_{i+1} : (u_{E_i}, v_{E_i}) &:= (u_{E_{i-1}}/v_{E_{i-1}}, v_{E_{i-1}}) = (0, 0) \quad (i \geq 2).
\end{aligned}$$

The action  $(\varphi_n)_* : \text{Pic}(X_n) \rightarrow \text{Pic}(X_{n+1})$  is

$$\begin{aligned}
H_0 &\mapsto 2H_0 + H_1 - A - B - C_1 - F_1 \\
H_1 &\mapsto H_0 \\
A &\mapsto H_0 - C_1 \\
B &\mapsto H_0 - F_1 \\
C_i &\mapsto C_{i+1} \quad (i \geq 1) \\
D_1 &\mapsto H_0 - B \\
D_i &\mapsto D_{i-1} \quad (i \geq 2) \\
E_1 &\mapsto H_0 - A \\
E_i &\mapsto E_{i-1} \quad (i \geq 2) \\
F_i &\mapsto F_{i+1} \quad (i \geq 1).
\end{aligned}$$

The degree of  $(\prod_{k=0}^{m-1} \varphi_{n+k})(x, y) = (P^m, Q^m)$ ,  $(m \geq 1)$ , can be calculated by

$$\begin{aligned}
\prod_{k=0}^{m-1} (\varphi_{n+k})_*(H_0) &= (m+1)H_0 + m(H_1 + A + B) - \sum_{i=1}^m C_i - \sum_{i=1}^m F_i \\
(\varphi_{n+k})_*(H_1) &= H_0
\end{aligned}$$

as  $\deg_x P^m = m-1$ ,  $\deg_y P^m = m$ ,  $\deg_x Q^m = m$ ,  $\deg_y Q^m = m+1$ .

## 4.2 Analytically stable surface

Similar to Section 3.3, the sequence of mappings  $\{\varphi_n\}$  is lifted to an analytically stable sequence. Let  $X$  be the surface obtained by the blow-ups  $\mu_A$  and  $\mu_B$ , then  $\{\varphi_n : X \rightarrow X\}$  is analytically stable (see Fig.5). Notice that  $X$  is independent of  $n$ , while this is not true for the more complicated Riccati mappings as in Sect.5.

The action  $(\varphi_n)_* : \text{Pic}(X) \rightarrow \text{Pic}(X)$  is

$$\begin{aligned}
H_0 &\mapsto 2H_0 + H_1 - A - B \\
H_1 &\mapsto H_0 \\
A &\mapsto H_0 \\
B &\mapsto H_0.
\end{aligned}$$

The invariant effective class in  $\text{Pic}(X)$  is

$$H_0 + H_1 - A - B \tag{15}$$

and the divisors in this class, i.e. divisors in  $\mathbb{P}^1 \times \mathbb{P}^1$  such that the class of their proper transforms is (15), are

$$c_1x + c_2y = 0,$$

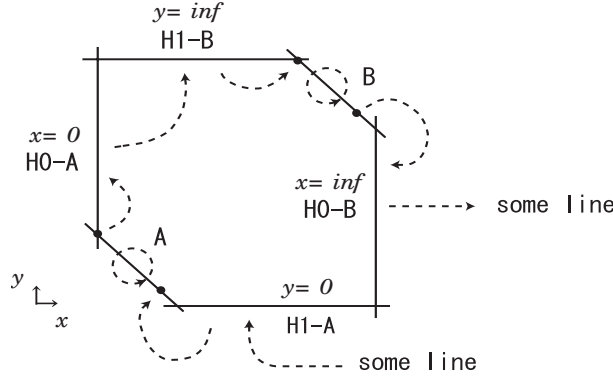

Figure 5: Sect.4.2

where  $c_1$  and  $c_2$  are nonzero constants in  $\mathbb{C}$ . Actually these lines pass through the points  $(x, y) = (0, 0), (\infty, \infty)$  with multiplicity 1. Here  $\{(c_1 : c_2)\} \simeq \mathbb{P}^1$  and the lines  $c_1x + c_2y = 0$  can be considered as the base space and as fibers respectively. Hence  $X$  has a fibration preserved by  $\varphi_n$ .

By putting  $u = -c_1/c_2 = y/x, v = x$   $\varphi$  is decomposed to mappings on the base space and on fibers as follows

$$\begin{cases} \bar{u} = u + a_n \\ \bar{v} = uv. \end{cases} \quad (16)$$

## 5 A more complicated Riccati system

In this section we consider the mapping

$$1 = \frac{f_{n-1} + f_{n+1} + k}{x_n} - \frac{f_{n-1} + f_n + k}{x_n + x_{n-1}} - \frac{f_n + f_{n+1} + k}{x_n + x_{n+1}}, \quad (17)$$

where  $f_n$ 's are free functions of  $n$  and  $k$  is a constant in  $\mathbb{C}$  (hence we can assume  $k = 0$  without loss of generality). This mapping is obtained by limiting process from the discrete Painlevé IV equation [14] and the degree grows linearly. Eq. (17) reduces to the mapping  $\varphi_n : \mathbb{P}^1 \times \mathbb{P}^1 \rightarrow \mathbb{P}^1 \times \mathbb{P}^1$ :

$$\begin{cases} \bar{x} = y \\ \bar{y} = -\frac{y(xy + y^2 - (f_{n-1} - f_n)x + 2f_ny)}{xy + y^2 - (f_{n-1} + f_{n+1})x + (f_n - f_{n+1})y} \end{cases} \quad (18)$$

and the indeterminate points of  $\varphi_n$  and  $\varphi_{n-1}^{-1}$  are  $(x, y) = (0, 0)$  and  $(\infty, \infty)$ .

### 5.1 Space of initial conditions

“The rational surfaces”  $X_n$  corresponding to  $\varphi$  for generic  $\{f_n\}$  is as Fig.6.

In the surface  $X_n$  the total transforms of the points of blow-ups are as follows

$$\begin{aligned} A &: (x, y) = (0, 0) \\ B_1 &: (1/x, 1/y) := (0, 0) \\ B_2 &: (u_{B_1}, v_{B_1}) := (1/x, x/y) = (0, -1) \end{aligned}$$

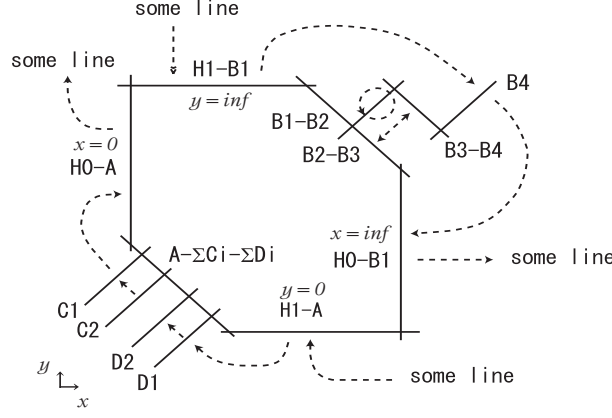

Figure 6: Sect.5.1

$$\begin{aligned}
B_3 : (u_{B_2}, v_{B_2}) &:= (u_{B_1}, \frac{v_{B_1} + 1}{u_{B_1}}) = (0, f_{n-1} + f_n) \\
B_4 : (u_{B_3}, v_{B_3}) &:= (u_{B_2}, \frac{v_{B_2} - (f_{n-1} + f_n)}{u_{B_2}}) = (0, -(f_{n-1} + f_n)2f_{n-1}) \\
C_1 : (u_A, v_A) &:= (x, y/x) = (0, \frac{f_{n-1} + f_{n+1}}{f_n - f_{n+1}}) =: c_{1,n} \\
C_i : (u_A, v_A) &= (0, \frac{(f_{n-1} - f_n) + (f_{n-1} + f_{n+1})c_{i-1,n+1}}{2f_n + (f_n - f_{n+1})c_{i-1,n+1}}) =: c_{i,n} \quad (i \geq 2) \\
D_1 : (u_A, v_A) &= (0, \frac{f_{n-1} - f_{n-2}}{f_n + f_{n-2}}) =: d_{1,n} \\
D_i : (u_A, v_A) &= (0, \frac{(f_{n-1} - f_{n-2}) + (2f_{n-1})d_{i-1,n-1}}{(f_{n-2} + f_n) + (f_n - f_{n-1})d_{i-1,n-1}}) =: d_{i,n} \quad (i \geq 2)
\end{aligned}$$

The action  $(\varphi_n)_* : \text{Pic}(X_n) \rightarrow \text{Pic}(X_{n+1})$  is

$$\begin{aligned}
H_0 &\mapsto 3H_0 + H_1 - A - B_1 - B_2 - B_3 - B_4 - D_1 \\
H_1 &\mapsto H_0 \\
A &\mapsto H_0 - D_1 \\
B_1 &\mapsto H_0 - B_4 \\
B_2 &\mapsto H_0 - B_3 \\
B_3 &\mapsto H_0 - B_2 \\
B_4 &\mapsto H_0 - B_1 \\
C_1 &\mapsto H_0 - A \\
C_i &\mapsto C_{i-1} \quad (i \geq 2) \\
D_i &\mapsto D_{i+1} \quad (i \geq 1).
\end{aligned} \tag{19}$$

The degree of  $(\prod_{k=0}^{m-1} \varphi_{n+k})(x, y) = (P^m, Q^m)$ ,  $(m \geq 1)$ , can be calculated by

$$\prod_{k=0}^{m-1} (\varphi_{n+k})_*(H_0) = (2m + 1)H_0 + (2m - 1)(H_1 - A) - m \sum_{l=1}^4 B_l - 2 \sum_{l=1}^{m-1} D_l - D_m$$

$$(\varphi_{n+k})_*(H_1) = H_0$$



as

$$\begin{aligned} \deg_x P &= 0, \quad \deg_x P^m = 2m - 3(m \geq 2), \\ \deg_y P^m &= 2m - 1, \quad \deg_x Q^m = 2m - 1, \quad \deg_y Q^m = 2m + 1(m \geq 1). \end{aligned}$$

## 5.2 Analytically stable surfaces

Let  $X_n$  be the surface obtained by the blow-ups  $\mu_A$  and  $\mu_{B_l}(l = 1, 2, 3, 4)$ , then  $\{\varphi_n : X_n \rightarrow X_{n+1}\}$  is analytically stable (see Fig.7).

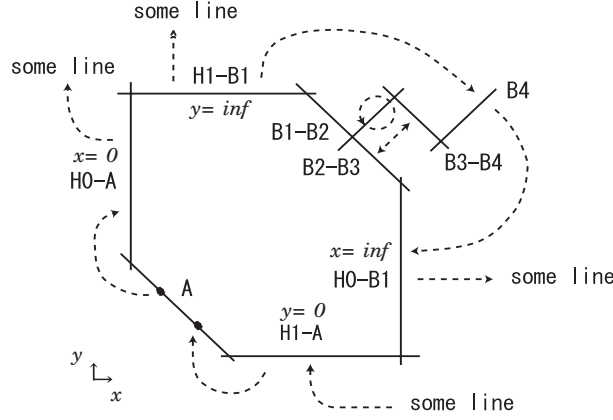

Figure 7: Sect.5.2

The action  $(\varphi_n)_* : \text{Pic}(X_n) \rightarrow \text{Pic}(X_{n+1})$  is

$$\begin{aligned} H_0 &\mapsto 3H_0 + H_1 - A - B_1 - B_2 - B_3 - B_4 \\ H_1 &\mapsto H_0 \\ A &\mapsto H_0 \\ B_1 &\mapsto H_0 - B_4 \\ B_2 &\mapsto H_0 - B_3 \\ B_3 &\mapsto H_0 - B_2 \\ B_4 &\mapsto H_0 - B_1. \end{aligned}$$

The invariant effective class in  $\text{Pic}(X_n) \simeq \text{Pic}(X_{n+1})$  is

$$2H_0 + 2H_1 - 2A - B_1 - B_2 - B_3 - B_4$$

and the divisors in this class are

$$c_1(x+y)^2 + c_2y(x^2 - f_n y + xy + f_{n-1}(2x+y)) = 0 \quad (20)$$

where  $c_1$  and  $c_2$  are nonzero constants in  $\mathbb{C}$ . Here  $\{(c_1 : c_2)\} \simeq \mathbb{P}^1$  and the curves (20) can be considered as the base space and as fibers respectively. Hence  $X$  has a fibration preserved by  $\varphi_n$ . Here the curve (20) has singular point  $(0, 0)$  and is birationally isomorphic to  $\mathbb{P}^1$ . Actually the line  $sx - y = 0$  intersects with the curve (20) at four points in  $\mathbb{P}^1 \times \mathbb{P}^1$ :  $(0, 0)$  (order 2),  $(\infty, \infty)$  and

$$\begin{cases} x = -\frac{c(1+s)^2 + s(-f_n s + f_{n-1}(2+s))}{s(1+s)} \\ y = -\frac{c(1+s)^2 + s(-f_n s + f_{n-1}(2+s))}{(1+s)}, \end{cases} \quad (21)$$

where  $c = c_1/c_2$ . Eq. (21) gives a birational isomorphism from  $s \in \mathbb{P}^1$  to the curves (20).

Using the new independent variables  $c$  and  $s$ ,  $\varphi$  reduces to

$$\begin{cases} \bar{c} &= \frac{f_{n-1} + f_n}{f_n + f_{n+1}}(c + f_{n-1} - f_n) \\ \bar{s} &= -\frac{(c + f_{n-1} - f_n)(s + 1)}{(c + f_{n-1} - f_n)s + c + f_{n-1} + f_{n+1}}. \end{cases} \quad (22)$$

Since  $d := (f_{n-1} + f_n)c + f_{n-1}^2$  is a constant, the first equation is easily integrated and the second equation is a projective mapping on  $\mathbb{P}^1$ .

### 5.3 Some autonomous case

In some autonomous cases the space of initial conditions is different from the generic case. We consider the case where  $f_n = -1/2a$  for all  $n$  in Eq. (18):

$$\begin{cases} \bar{x} &= y \\ \bar{y} &= -\frac{y^2(ax + ay - 1)}{axy + ay^2 + x} \end{cases} \quad (23)$$

“The rational surfaces”  $X_n$  corresponding to Eq.(23) is as Fig.8.

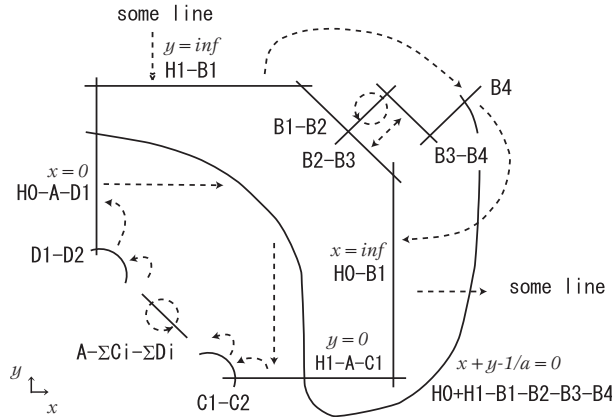

Figure 8: Sect.5.3

In the surface  $X_n$  the total transforms of the points of blow-ups are as follows

$$\begin{aligned} A &: (x, y) = (0, 0) \\ B_1 &: (1/x, 1/y) := (0, 0) \\ B_2 &: (u_{B_1}, v_{B_1}) := (1/x, x/y) = (0, -1) \\ B_3 &: (u_{B_2}, v_{B_2}) := (u_{B_1}, \frac{v_{B_1} + 1}{u_{B_1}}) = (0, -1/a) \\ B_4 &: (u_{B_3}, v_{B_3}) := (u_{B_2}, \frac{v_{B_2} + 1/a}{u_{B_2}}) = (0, -1/a^2) \\ C_i &: (x/y, y^i/x^{i-1}) := (0, 0) \quad (i \geq 1) \\ D_1 &: (x^i/y^{i-1}, y/x) := (0, 0) \quad (i \geq 1) \end{aligned}$$

While the action of  $(\varphi_n)_*$  on the curves themselves is different from the generic case, the action  $(\varphi_n)_* : \text{Pic}(X_n) \rightarrow \text{Pic}(X_{n+1})$  is the same as (19). Hence the invariant effective class is the same as in the generic case.

## 6 Conclusion

In this paper, we have studied the space of initial conditions for a family of linearisable mappings. These mappings have been obtained either in studies of projective systems or through limiting procedures of discrete Painlevé equations. They are in general nonautonomous and, except for the projective cases, they possess unconfined singularities. Despite this fact (which necessitates in principle an infinite number of blow-ups) we were able to construct the space of initial conditions and the analytically stable sequence of surfaces.

We have also shown that the degrees of iterated mappings can be calculated by considering the action on the Picard groups of these sequence of surfaces. In the case of Riccati type equations, the degrees of which grow linearly and in the autonomous case these belong to the ruled surface case in [16], we have shown that

- i) the corresponding surfaces have fibrations such that the fibers are mapped to the fibers of the next surface
- ii) by using these fibrations we can reduce such mapping to two projective mappings in cascade, i.e. a projective mapping on the base space and that on fibers, where the solution of the former one can be used in the coefficients in the second one.

Many more mappings, which are integrable through linearisation or whose degree grows linearly, have been derived in the past few years. It would be interesting to examine them using the tools we have presented in this paper.

## References

- [1] Ramani A, Grammaticos B and Hietarinta J 1991 Discrete versions of the Painlevé equations *Phys. Rev. Lett.* **67** 1829–1832
- [2] Grammaticos B, Ramani A and Papageorgiou V 1991 Do integrable mappings have the Painlevé property? *Phys. Rev. Lett.* **67** 1825–1827
- [3] Hietarinta J and Viallet C M 1997 Singularity confinement and chaos in discrete systems *Phys. Rev. Lett.* **81** 325–328
- [4] Bellon M P and Viallet C M 1999 Algebraic entropy *Commun. Math. Phys.* **204** 425–437
- [5] Gizatullin M H 1980 Rational  $G$ -surfaces *Izv. Akad. Nauk SSSR Ser. Mat.* **44** no.1 110–144
- [6] Arnold V I 1990 Dynamics of complexity of intersections *Bol. Soc. Bras. Mat.* **21** 1–10
- [7] Cantat S 1999 Dynamique des automorphismes des surfaces projectives complexes. *C. R. Acad. Sci. Paris Sr. I Math.* **328** no.10 901–906
- [8] Sakai H 2001 Rational surfaces associated with affine root systems and geometry of the Painlevé equations *Commun. Math. Phys.* **220** 165–229
- [9] Okamoto K 1979 Sur les feuilletages associés aux équations du second ordre à points critiques fixes de P.Painlevé (French) *Japan J. Math.* **5** 1–79
- [10] Takenawa T 2001 A geometric approach to singularity confinement and algebraic entropy *J. Phys. A: Math. Gen.* **34** L95–L102

- [11] Takenawa T 2001 Algebraic entropy and the space of initial conditions for discrete dynamical systems *J. Phys. A: Math. Gen.* **34** 10533–10545
- [12] Takenawa T 2001 Discrete dynamical systems associated with root systems of indefinite type *Commun. Math. Phys.* **224** 657–681
- [13] Ramani A, Grammaticos B, Lafortune S and Ohta Y 2000 Linearizable mappings and the low-growth criterion *J. Phys. A: Math. Gen.* **33** L287–L292
- [14] Ramani A, Ohta Y and Grammaticos B 2000 Discrete integrable systems from continuous Painlevé equations through limiting procedures *Nonlinearity* **13** 1073–1085
- [15] Sibony N 1999 *Dynamique des applications rationnelles de  $\mathbb{P}^k$*  (*Panor. Synthèses*, 8) 97–185 (Paris: Soc. Math. France)
- [16] Diller J A and Favre C 2001 Dynamics of bimeromorphic maps of surfaces *Amer. J. Math.* **123** no.6 1135–1169
- [17] Beauville A 1996 *Complex algebraic Surfaces 2nd edn.* (Cambridge: Cambridge University Press)
- [18] Fulton W 1984 *Intersection theory, vol.2 Ergebnisse der Mathematik und ihrer Grenzgebiete (3)* (Berlin: Springer-verlag)