

Liapunov Multipliers and Decay of Correlations in Dynamical Systems

P. Collet¹ and J.-P. Eckmann^{2,3}

¹Centre de Physique Théorique, Laboratoire CNRS UMR 7644, Ecole Polytechnique, F-91128 Palaiseau Cedex, France

²Dépt. de Physique Théorique, Université de Genève, CH-1211 Genève 4, Switzerland

³Section de Mathématiques, Université de Genève, CH-1211 Genève 4, Switzerland

Dedicated to Gianni Jona-Lasinio in gratitude for his many encouragements.

Abstract. The essential decorrelation rate of a hyperbolic dynamical system is the decay rate of time-correlations one expects to see stably for typical observables once resonances are projected out. We define and illustrate these notions and study the conjecture that for observables in C^1 , the essential decorrelation rate is never faster than what is dictated by the *smallest* unstable Liapunov multiplier.

1. Introduction

The purpose of this paper is a discussion of the relation between the decay of time-correlations and the Liapunov exponents of dynamical systems. It is well-known that if a system has vanishing Liapunov exponents, in general the decay of correlations can be arbitrarily slow. Here, we study the case when the Liapunov exponents are all *different* from 0. The decay of time-correlations in a dynamical system depends in general on the type of observable one considers. We will explain below why, in our view, the class C^1 of once differentiable observables is a natural and useful choice. Whatever the choice, it implies a notion of *essential decorrelation rate*, also to be defined below. Its intuitive meaning is perhaps best understood in terms of *resonances* or *improvable decorrelation rates* [15,16]. These are rates which will be seen usually for any randomly picked observable and which are *slower* than the essential ones. But they are improvable in the following sense. For any $\varepsilon > 0$, there is a finite dimensional subspace of such observables, and if we take any other observable in the complement of this subspace, we will see the essential decorrelation rate within ε . It is precisely called essential, because no further *finite dimensional* restriction of observables will lead to a faster decorrelation rate.

We will first define with mathematical precision an *essential decorrelation radius* ϱ_{ess} which is the inverse of the essential decorrelation rate λ_{ess} . We will then show by means of some examples that systems with *improvable decorrelation rates really exist*. We then address the question of the essential decorrelation radius. We will study for observables in C^1 and for several expanding systems the validity of the inequality

$$\varrho_{\text{ess}} \equiv 1/\lambda_{\text{ess}} \geq 1/\lambda_{\min}, \quad (1.1)$$

where $\log \lambda_{\min}$ is the **smallest** positive Liapunov multiplier.¹ We also argue that in many cases

¹ The Liapunov exponent is the logarithm of the Liapunov multiplier

the inequality above is strict, so that the (essential) decay rate of correlations is even *slower* than what is suggested by the smallest positive Liapunov multiplier.²

Our paper deals thus with lower bounds not only on the essential spectrum, but also on the essential decorrelation radius. For related work, see [17].

2. Setup

We consider throughout a smooth manifold \mathcal{M} of dimension d , and a (piecewise) smooth map f of \mathcal{M} into itself. The differential of f (a $d \times d$ matrix) is denoted Df , and $Df(x)$ or $Df|_x$ when evaluated at the point x . Two quantities of interest in “chaotic” systems are the *Liapunov multipliers* and the correlation functions. The Liapunov multipliers are obtained by considering first the matrices

$$\Lambda_n(x) = Df(f^{n-1}(x)) \cdot Df(f^{n-2}(x)) \cdots Df(x) \equiv \prod_{i=0}^{n-1} Df(f^i(x)) .$$

By Oseledec’ theorem, given an invariant measure ν , the Liapunov multipliers are then the eigenvalues of the matrix

$$\lim_{n \rightarrow \infty} (\Lambda_n(x)^* \Lambda_n(x))^{\frac{1}{2n}} , \quad (2.1)$$

(which exists ν almost everywhere)³. If the system is in addition ergodic with respect to the invariant measure, then these eigenvalues are ν -almost surely independent of x . Note that the Liapunov multipliers will in general depend on ν when there are several invariant measures. We will call these multipliers⁴

$$\lambda_1 \geq \lambda_2 \geq \cdots \geq \lambda_d .$$

Recall also that for SRB measures the limit in (2.1) exists Lebesgue almost surely (in the basin of the measure) and not only on the support of the measure ν which may be of Lebesgue measure zero.

A second quantity of interest are correlation functions. Consider two observables, F and G , which are functions on \mathcal{M} taking real values. Here, and throughout the paper, we will assume that F and G have zero mean. Then we can form the correlation functions

$$S_k(x) = \lim_{n \rightarrow \infty} \frac{1}{n} \sum_{j=0}^{n-1} F(f^{j+k}(x)) G(f^j(x)) .$$

Again, $S_k(x)$ is Lebesgue almost surely independent of x and is also equal to

$$S_k = \int d\mu(x) F(f^k(x)) G(x) ,$$

² It is somewhat anti-intuitive that the lowest and not the largest Liapunov exponent matters, when compared with the idea that Liapunov exponents are separation rates, but the reader should note that decay rates are really infinite time quantities, and the fast local separation of orbits only works for a short time, and only for a few avoidable observables.

³ We always write λ for the Liapunov multiplier, and $\log \lambda$ for the corresponding Liapunov exponent.

⁴ They depend on the invariant measure.

where μ is the SRB measure (assuming it exists).

A question of interest is the relation between the rate of decay of S_k as $k \rightarrow \infty$ and the Liapunov multipliers. A tempting idea is to argue that since the orbits seem to separate at a rate λ_1 (per unit time) the observables should decorrelate like

$$|S_k| \gtrsim \frac{C}{\lambda_1^k}, \quad (2.2)$$

for some constant C . While this property is in a way true for *short times* (small k) because generally there is a component of the observables which “feels” the fast rate of the largest Liapunov multiplier, the purpose of this paper is to show that (2.2) **does not hold** asymptotically in general.

First of all, closer scrutiny of the separation argument given above indicates that the expected behavior of S_k should be dictated not by the largest Liapunov multiplier, but rather by the *smallest above 1*:

$$|S_k| \gtrsim \frac{C}{\lambda_{\min}^k}, \quad (2.3)$$

where⁵

$$\lambda_{\min} = \min\{\lambda_i : \lambda_i > 1\}. \quad (2.4)$$

We will see that (2.3) holds for certain special examples, but for a general map the Equation (2.3) **cannot be an equality** for generic observables in \mathcal{C}^1 , even if we avoid the resonances. Namely, we expect for maps f with non-constant derivative and for observables in \mathcal{C}^1 an inequality

$$|S_k| \gtrsim \frac{C}{\lambda_{\text{ess}}^k}, \quad (2.5)$$

with $1 < \lambda_{\text{ess}} < \lambda_{\min}$: **In general, the decorrelation is slower than C/λ_{\min}^k** . Furthermore, λ_{ess} is a much stronger barrier to decay than the resonances: Only a very radical restriction of the observables (to a subspace of \mathcal{C}^1 with *infinite* codimension) will in general lead to a faster decay.

The purpose of this paper is to clarify the issues related to these questions.

⁵ We do not consider systems with Liapunov multipliers equal to 1, where it is known that the decorrelation rate may not even be exponential.

3. The Essential Decorrelation Radius

In this section we define the essential decorrelation radius ϱ_{ess} . The essential decorrelation rate λ_{ess} is then defined by

$$\lambda_{\text{ess}} = 1/\varrho_{\text{ess}} ,$$

so that the correlation functions S_k will basically decay like $\lambda_{\text{ess}}^{-k} = \varrho_{\text{ess}}^k$.

The definition of ϱ_{ess} depends on two Banach⁶ spaces X and Y , with X a subspace of the dual of Y . The reader should think of X and Y as the Banach space of \mathcal{C}^1 functions with the norm $\|h\| = \sup_x |h(x)| + \sup_x |Dh(x)|$, but we will need more complicated spaces later. We denote by $\langle \cdot, \cdot \rangle$ the continuous bilinear form on $Y \times X$ which is the restriction of the pairing of Y with its dual.

Definition 3.1. *Let U be a bounded linear operator on X . We define the essential decorrelation radius of U on X, Y by*

$$\varrho_{\text{ess}}(X, Y, U) = \inf_{\substack{\text{Codim } M < \infty \\ \text{Codim } M' < \infty}} \limsup_{n \rightarrow \infty} \left(\sup_{x \in M \setminus \{0\}, y \in M' \setminus \{0\}} \frac{|\langle y, U^n x \rangle|}{\|x\| \|y\|} \right)^{1/n} . \quad (3.1)$$

Remark. The reason we want the space X to be invariant under U is to make connection later on with the spectral radius. This will force us to use spaces X whose definitions are a little involved. Although such a problem does not seem to appear in the definition of the correlation function, it is hidden in the duality relation between the two observables.

The idea of Definition 3.1 is to peel-out the various finite dimensional spectral subspaces corresponding to eigenvalues outside of the essential spectral radius.

The essential spectral radius σ_{ess} of U on X can be defined in many equivalent ways, see e.g., [5, p. 44]. For our purpose the following one will be used ($r_{e_2}(U)$ in [5]):

Definition 3.2. *Let U be a continuous linear operator on X . We define the essential spectral radius by*

$$\sigma_{\text{ess}}(X, U) = \sup\{|\lambda| : \dim \text{Ker}(U - \lambda \mathbf{1}) = \infty \text{ or } (U - \lambda \mathbf{1})X \text{ is not closed}\} , \quad (3.2)$$

and the point-essential spectral radius by

$$\sigma_{\text{p-ess}}(X, U) = \sup\{|\lambda| : \lambda \in \mathbf{C} \text{ is an accumulation point of eigenvalues or an eigenvalue of infinite multiplicity}\} . \quad (3.3)$$

Theorem 3.3. *Let U be a continuous linear operator on X . If $X \subset Y^*$, then*

$$\varrho_{\text{ess}}(X, Y, U) \geq \sigma_{\text{p-ess}}(X, U) . \quad (3.4)$$

⁶ Hilbert spaces are not adequate since we work with functions in \mathcal{C}^1 .

Remark. It would be much nicer if we knew that $\varrho_{\text{ess}}(X, Y, U) \geq \sigma_{\text{ess}}(X, U)$. Some of the difficulties of this paper would disappear, and the considerations of Section 8 and Section 9 would immediately give the inequality (2.5). Nevertheless, Theorem 3.3 is still somewhat useful because information on $\sigma_{\text{p-ess}}$ is relatively easy to get at. One might be tempted to conjecture that $\varrho_{\text{ess}}(X, Y, U) \geq \sigma_{\text{ess}}(X, U)$. However, we found no proof, since we do not know those λ for which $U - \lambda$ has closed range. On the other hand, for those U and X we will consider, we shall find $\sigma_{\text{p-ess}}(X, U) = \sigma_{\text{ess}}(X, U)$, so that in the end, we still have the more useful inequality $\varrho_{\text{ess}}(X, Y, U) \geq \sigma_{\text{ess}}(X, U)$ in those cases.

Proof of Theorem 3.3. We first use the following

Lemma 3.4. *With the notations of Definition 3.1 one has the identity*

$$\begin{aligned} & \inf_{\substack{\text{Codim } M < \infty \\ \text{Codim } M' < \infty}} \limsup_{n \rightarrow \infty} \left(\sup_{x \in M \setminus \{0\}, y \in M' \setminus \{0\}} \frac{|\langle y, U^n x \rangle|}{\|x\| \|y\|} \right)^{1/n} \\ &= \inf_{\substack{\text{Codim } M < \infty, M \text{ closed} \\ \text{Codim } M' < \infty, M' \text{ closed}}} \limsup_{n \rightarrow \infty} \left(\sup_{x \in M \setminus \{0\}, y \in M' \setminus \{0\}} \frac{|\langle y, U^n x \rangle|}{\|x\| \|y\|} \right)^{1/n}. \end{aligned} \quad (3.5)$$

Remark. The proof of this lemma will be given in the Appendix. The problem of non-closed subspaces is a well-known nuisance in controlling intersection, see *e.g.*, [8, footnote 2, p. 132]. The above lemma helps avoiding these esoteric problems.

We consider a complex number $\lambda \neq 0$ together with a sequence (λ_j) of complex numbers converging to λ (some terms of the sequence and possibly infinitely many may be equal to λ), which are eigenvectors of U in X associated to the sequence of independent eigenvectors (e_j) . We claim that $\varrho_{\text{ess}} \geq |\lambda|$. To prove this we will show that for any subspaces $M \subset X$ and $M' \subset Y$, both of finite codimension, we have

$$|\lambda| \leq \limsup_{n \rightarrow \infty} \left(\sup_{x \in M, y \in M'} \frac{|\langle y, U^n x \rangle|}{\|y\| \|x\|} \right)^{1/n}. \quad (3.6)$$

By Lemma 3.4, it is enough to show this for closed subspaces M and M' . Let $\varepsilon > 0$ and denote by s and s' the codimensions of M and M' , respectively. Let W be a subspace generated by $s + s' + 1$ vectors among the infinite sequence (e_j) with respective eigenvalues of modulus larger than $|\lambda| - \varepsilon$. From our hypothesis, this is always possible. We have $\dim(W \cap M) \geq s' + 1$, see [8, problem 1.42, p. 142].

From [8, Lemma 1.40, p. 141] we conclude that (in Y^*) one has $s' = \dim M'^{\perp}$ and therefore, since $X \subset Y^*$ by assumption, we find

$$W \cap M \not\subset M'^{\perp}.$$

This implies that there are a $w \in W \cap M$ and a $v \in M'$ such that $\langle v, w \rangle \neq 0$. Therefore, there is at least one e_ℓ among those generating W for which $\langle v, e_\ell \rangle \neq 0$. Since the associated eigenvalue λ_ℓ satisfies $|\lambda_\ell| \geq |\lambda| - \varepsilon$, we get

$$\limsup_{n \rightarrow \infty} \left(\sup_{\substack{x \in M \\ y \in M'}} \frac{|\langle y, U^n x \rangle|}{\|y\| \|x\|} \right)^{1/n} \geq \limsup_{n \rightarrow \infty} \left(\frac{|\langle v, U^n e_\ell \rangle|}{\|v\| \|e_\ell\|} \right)^{1/n} = |\lambda_\ell| \geq |\lambda| - \varepsilon.$$

We conclude that for any $\varepsilon > 0$,

$$\varrho_{\text{ess}} \geq |\lambda| - \varepsilon.$$

Since $\varepsilon > 0$ is arbitrary, we conclude $\varrho_{\text{ess}} \geq |\lambda|$ as asserted. Theorem 3.3 follows immediately from the definition of $\sigma_{p-\text{ess}}$.

4. Baladi Map in 1 Dimension

In this section we focus on *resonances*, by giving a 1-dimensional example. In Section 5 we give a 2-dimensional, area-preserving example and in Section 7 we show how this example can be generalized to unequal slopes. This provides then an example with resonances *and* for which the decay rate is *not* given by $1/\lambda_{\min}$, but by $1/\lambda_{\text{ess}}$ as explained in the Introduction and in Section 2.

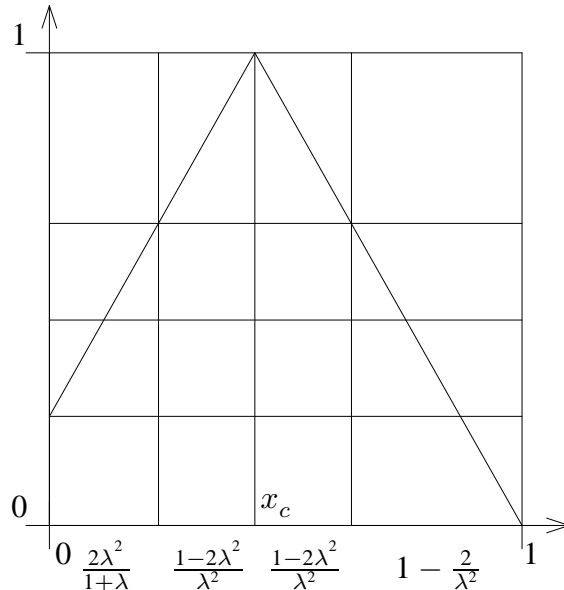

Fig. 1: The graph of the Baladi map.

Since there is only one Liapunov multiplier in dimension 1, we shall write λ instead of λ_{\min} . There are many maps of the interval with a slope of constant modulus $\lambda > 1$, which are

Markov and which have resonances in the correlation function. By a systematic search, Baladi [1] found the simplest such map, whose partition has only four pieces. The map (which we will call f) is drawn in Fig. 1 and is defined by

$$f(x) = \begin{cases} \lambda(x - x_c) + 1, & \text{if } x \leq x_c, \\ -\lambda(x - x_c) + 1, & \text{if } x \geq x_c, \end{cases}$$

where $x_c = \frac{2\lambda^2}{1+\lambda} + \frac{1-2\lambda^2}{\lambda^2}$. Note that it has a slope $\pm\lambda$, where $\lambda > 1$. Baladi obtained λ as follows: If we call P_1, \dots, P_4 the four pieces of the partition of $[0, 1]$ as shown on the bottom of Fig. 1, we see that $f(P_1) = P_2 \cup P_3$, $f(P_2) = f(P_3) = P_4$, and $f(P_4) = P_1 \cup P_2 \cup P_3$. Therefore, the transition matrix M (the Markov matrix) defined by $M_{i,j} = 1$ if $P_j \subset f(P_i)$ and zero otherwise is given by:

$$M = \begin{pmatrix} 0 & 0 & 0 & 1 \\ 1 & 0 & 0 & 1 \\ 1 & 0 & 0 & 1 \\ 0 & 1 & 1 & 0 \end{pmatrix}.$$

Its characteristic polynomial is

$$\lambda^4 - 2\lambda^2 - 2\lambda,$$

and its eigenvalues are

$$\lambda \approx 1.76929, \quad \lambda_{r,\pm} \approx -0.884846 \pm i0.58973, \quad \text{and } 0.$$

The reader will check easily that the maximal eigenvalue is the right choice of λ . The correlation functions are given by

$$S_k = \int dx F(x)G(f^k(x))h(x),$$

where the density h of the invariant measure (which is unique among the absolutely continuous invariant measures) is given by

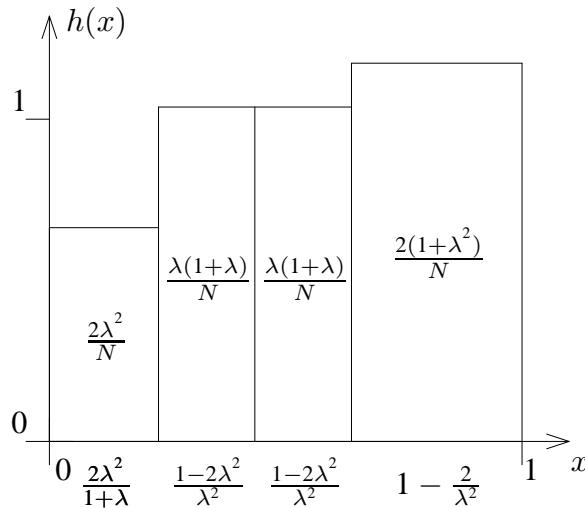

Fig. 2: The density h of the invariant measure. The normalization factor is $N = (2\lambda^3 - \lambda - 2)/\lambda^2$.

$$h(x) = \begin{cases} \alpha \equiv \lambda^2/N, & \text{if } x < 2\lambda^2/(1+\lambda) \equiv x_1, \\ \beta \equiv \lambda(1+\lambda)/N, & \text{if } 2\lambda^2/(1+\lambda) < x < 2/\lambda^2 \equiv x_2, \\ \gamma \equiv 2(1+\lambda)/N, & \text{if } 2/\lambda^2 < x < 1, \end{cases} \quad (4.1)$$

and $N = (2\lambda^3 - \lambda - 2)/\lambda^2$ is a normalization. Changing variables to $y = f^{-1}(x)$ one gets

$$S_k = \int dy (P^k(Fh))(y)G(y),$$

where P is the Perron-Frobenius operator

$$(Pg)(y) = \sum_{x:f(x)=y} \frac{g(x)}{|f'(x)|}.$$

Note that since $|f'(x)| \equiv \lambda$ for our example, the Perron-Frobenius operator in this case equals $\lambda^{-1}M$ when acting on functions which are constant on the four pieces of the Markov partition. Therefore, on that space, its eigenvalues are given by

$$1, \quad \frac{\lambda_{r,\pm}}{\lambda} \approx \frac{-0.884846 \pm i 0.58973}{1.76929}, \quad \text{and } 0.$$

It follows that for generic observables *the correlation functions decay like*

$$|S_k| \gtrsim C \left| \frac{\lambda_{r,\pm}}{\lambda} \right|^k. \quad (4.2)$$

This decay rate is *slower* than $C|1/\lambda|^k$ because $|\lambda_{r,\pm}| \approx 1.06320$. We illustrate these findings by numerical experiments in Fig. 3 and Fig. 4. The question is now whether $C \neq 0$. The matrix M has an eigenvector $v_1 = (\alpha, \beta, \beta, \gamma)$ as defined in (4.1) corresponding to the eigenvalue λ , a 2 dimensional eigen-subspace corresponding to the eigenvalues $\lambda_{r,\pm}$ (spanned by some vectors v_2 and v_3), and a fourth eigendirection $v_4 = (0, 1, -1, 0)$ corresponding to the eigenvalue 0. These are also eigenspaces for $\lambda^{-1}P$. We see that *if the function $F \cdot h$ does not have any component in the subspace spanned by v_2, v_3 , then $C = 0$, and the decay of S_k is faster than described in (4.2).*⁷ In all other cases, $C \neq 0$ and (4.2) describes the relevant decay rate. We will therefore say that $\lambda_{r,\pm}/\lambda$ are **resonances**, see [15,16], because they can be avoided by choosing observables (with zero average) in a subspace of codimension 2.

⁷ Strictly speaking, we have shown this only for functions which are constant on the pieces of the partition. The proof of the general case is left to the reader.

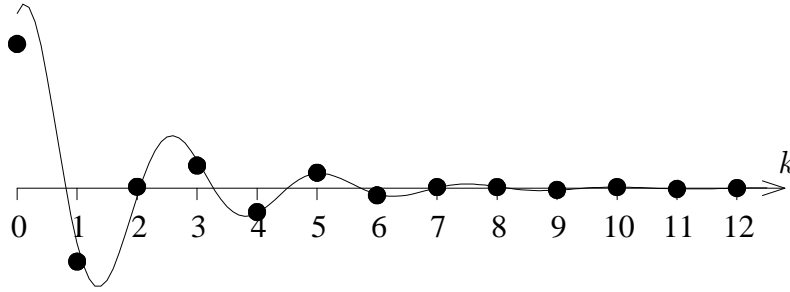

Fig. 3: A numerical study of the correlation function S_k for the 1-dimensional Baladi map, from $3 \cdot 10^7$ data points. The continuous graph is the theoretical curve, $\text{const. Re}(\lambda_{r,+}/\lambda)^k$.

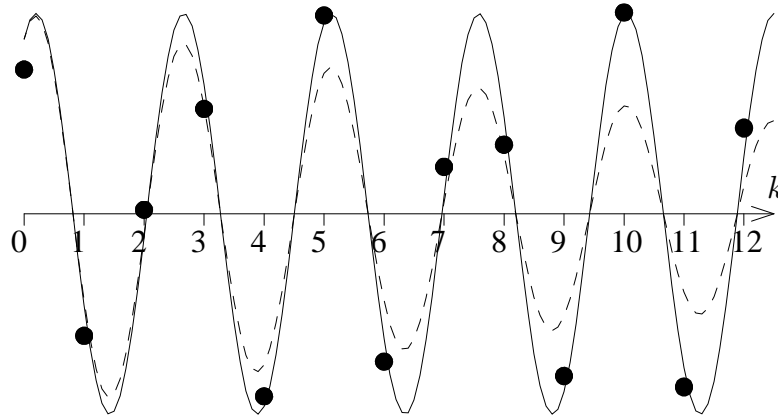

Fig. 4: The same data as in Fig. 3 but now scaled vertically by $|\lambda_{r,+}/\lambda|^{-k}$. Superposed is the (dashed) curve scaled by $(1/\lambda)^{-k}$ which shows clearly the difference between the decay rate of the resonance $\lambda_{r,\pm}/\lambda$ and that of the inverse of the Liapunov multiplier which is $1/\lambda$.

5. A Skew Product Using a Baladi Map

Using the Baladi map f of the preceding section, we can construct a new map, Φ which is area-preserving, invertible, hyperbolic, and has a resonance (the same as in Section 4). The map is defined as in Fig. 5. In formulas:

$$\Phi(x, y) = (f(x), y/\lambda + t(x)/N),$$

with λ as in the previous section and where t is given by

$$t(x) = \begin{cases} 2\lambda^2, & \text{if } x < \frac{2\lambda^2}{1+\lambda}, \\ 1 + \lambda^2, & \text{if } \frac{2\lambda^2}{1+\lambda} < x < \frac{2\lambda^2+3\lambda+1}{\lambda^3+\lambda^2}, \\ 0, & \text{if } \frac{2\lambda^2+3\lambda+1}{\lambda^3+\lambda^2} < x < \frac{2}{\lambda^2}, \\ 0, & \text{if } \frac{2}{\lambda^2} < x. \end{cases}$$

Since the first component of Φ is the 1-dimensional map f we discussed above, we see that correlation functions for observables depending only on x will show the resonances we found

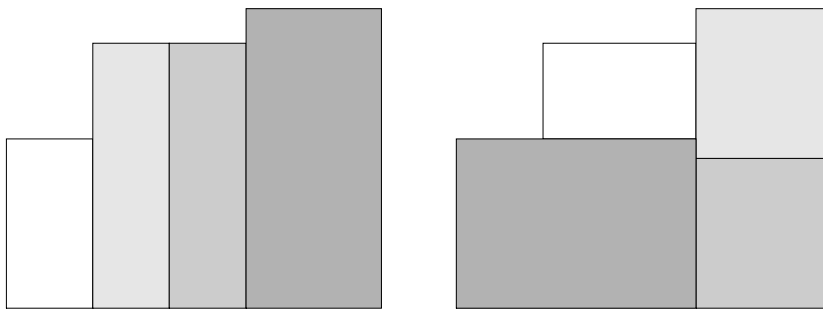

Fig. 5: The map Φ maps the left puzzle affinely onto the right puzzle, respecting the shadings. Note that horizontally, all domains are stretched (by λ) under the map, while the vertical directions are squeezed (by λ). Also note that the overall shape of the domain is that of the graph of h of Fig. 2

there. But the map is uniformly contracting in the y direction, and furthermore, we have the explicit expression

$$\Phi^n(x, y) = \left(f^n(x), \frac{y}{\lambda^n} + \frac{\sum_{j=0}^{n-1} t(f^j(x))}{\lambda^{n-j+1}} \right).$$

If F depends only on x and is of the form $F(x, y) = u(x)$ we get

$$\int dx dy F(\Phi^n(x, y)) G(x, y) = \int dx u(f^n(x)) v(x) dx,$$

where

$$v(x) = \int dy G(x, y).$$

Therefore, by the results of the preceding section, for generic u and $G \in \mathcal{C}^1$ we get a rate of decay of correlations $|\lambda_{r,\pm}/\lambda|$. On the other hand, there is a codimension two subspace of functions G such that the decay rate drops down to $1/\lambda$.

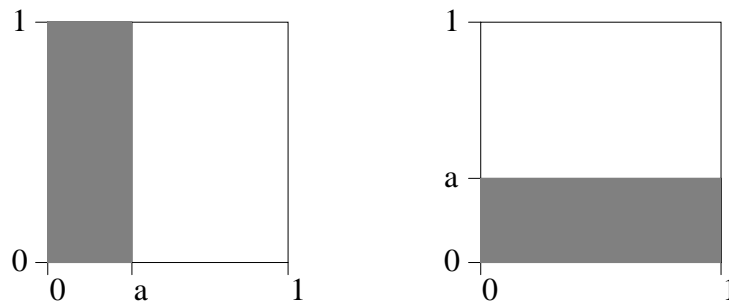

Fig. 6: An asymmetric baker map. The gray rectangle on the left is mapped (preserving orientation) affinely on the gray rectangle on the right. The white rectangle is mapped on the white rectangle.

6. Asymmetric Baker Map with Non-Trivial Essential Decorrelation Radius

In this section we give examples of maps whose essential decorrelation radius for observables in C^1 larger than $1/\lambda_{\min}$. These maps f_a are usually called asymmetric baker maps. These are maps from $[0, 1] \times [0, 1]$ which are defined as follows. Fix $a \in (0, 1)$. Then one defines

$$f_a \begin{pmatrix} x \\ y \end{pmatrix} = \begin{cases} \begin{pmatrix} \frac{1}{a} & 0 \\ 0 & a \end{pmatrix} \begin{pmatrix} x \\ y \end{pmatrix}, & \text{if } 0 \leq x \leq a, \\ \begin{pmatrix} \frac{1}{1-a} & 0 \\ 0 & 1-a \end{pmatrix} \begin{pmatrix} x \\ y \end{pmatrix} + \begin{pmatrix} \frac{-a}{1-a} \\ \frac{-a}{a} \end{pmatrix}, & \text{if } a < x \leq 1. \end{cases}$$

These maps have Jacobian equal to 1 everywhere, are invertible, and the Lebesgue measure μ is the only absolutely continuous invariant measure. The inverse is given by

$$f_a^{-1} \begin{pmatrix} x \\ y \end{pmatrix} = \begin{cases} \begin{pmatrix} a & 0 \\ 0 & \frac{1}{a} \end{pmatrix} \begin{pmatrix} x \\ y \end{pmatrix}, & \text{if } 0 \leq y \leq a, \\ \begin{pmatrix} 1-a & 0 \\ 0 & \frac{1}{1-a} \end{pmatrix} \begin{pmatrix} x \\ y \end{pmatrix} + \begin{pmatrix} a \\ \frac{-a}{1-a} \end{pmatrix}, & \text{if } a < y \leq 1. \end{cases}$$

The Liapunov multipliers of f_a are the exponentials of

$$\mp (\mu(\{y < a\}) \log a + \mu(\{y > a\}) \log(1-a)),$$

and so we find:

$$\lambda_- = 1/\lambda_+ = a^a \cdot (1-a)^{1-a} \leq 1.$$

Note that with our notation, $\lambda_{\min} = \lambda_+$.

We next study the decay of the correlation functions. Consider the two observables:

$$F(x, y) = \partial_x u(x), \quad G(x, y) = x, \quad (6.1)$$

with $u(0) = u(1) = 0$, $u \geq 0$, $u \not\equiv 0$. Note that since F has zero average, it is not necessary to impose that G has zero average. Then, with $z = (x, y)$ we find

$$\begin{aligned} S_k &= \int d^2 z F(f^k(z)) G(z) = \int d^2 z F(z) G(f^{-k}(z)) \\ &= \int d^2 z u'(x) G(f^{-k}(z)). \end{aligned}$$

When y is fixed, we let I_y be the horizontal segment $I_y = \{(x, y) : x \in [0, 1]\}$. Note that $f^{-k}|_{I_y}$ is regular, without discontinuities. Therefore, we can integrate by parts and get

$$S_k = - \int d^2 z u(x) \partial_x G(f^{-k}(z)) \cdot \partial_x (f^{-k})_1(z). \quad (6.2)$$

By construction $\partial_x G \equiv 1$ and thus we find with $e_1 \equiv \begin{pmatrix} 1 \\ 0 \end{pmatrix}$:

$$\begin{aligned} S_k &= - \int d^2 z u(x) \partial_x (f^{-k})_1(z) = - \int d^2 z u(x) D(f^{-k}) \Big|_z e_1 \\ &= - \int d^2 z u(x) \\ &\quad \cdot \exp \left(\log a \cdot \sum_{j=0}^{k-1} \chi_{y < a}(f^{-j}(z)) + \log(1-a) \cdot \sum_{j=0}^{k-1} \chi_{y > a}(f^{-j}(z)) \right). \end{aligned}$$

Note that the exponential does not depend on the first component x of $z \in \mathbf{R}^2$ and thus we can integrate over x and obtain

$$S_k = - \int dy \exp \left(\log a \cdot \sum_{j=0}^{k-1} \chi_{y < a}(f^{-j}(z)) + \log(1-a) \cdot \sum_{j=0}^{k-1} \chi_{y > a}(f^{-j}(z)) \right).$$

By an explicit computation we see that the integral over y equals

$$\begin{aligned} &\sum_{j=0}^{k-1} \binom{k-1}{j} a^j (1-a)^{k-1-j} \exp(j \log a + (k-1-j) \log(1-a)) \\ &= \sum_{j=0}^{k-1} \binom{k-1}{j} a^j (1-a)^{k-1-j} a^j (1-a)^{k-1-j} \\ &= (a^2 + (1-a)^2)^{k-1}. \end{aligned}$$

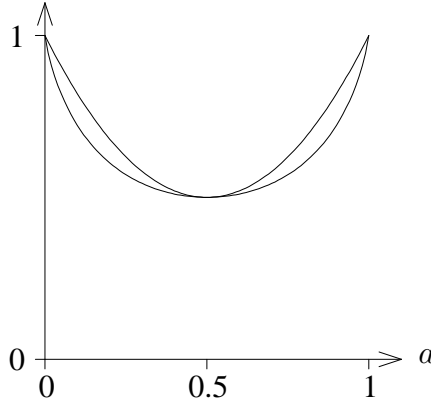

Fig. 7: The *upper* curve shows the rates of decay $1/\lambda_{\min} = 1/\lambda_{\text{ess}} = a^2 + (1-a)^2$ as a function of a , and the *lower* curve shows $1/\lambda_+ = a^a(1-a)^{1-a}$. One can see that the decay is generally *slower* than $1/\lambda_+ = 1/\lambda_{\min}$.

At this point one needs to show that enough functions F and G have been constructed to really characterize the essential decorrelation radius. This follows by a (simpler) application of the ideas of Section 10. Note, however, that the basic ingredient will still be the integration by parts formula (6.2). Leaving this problem aside, we get

$$|S_k| \geq C(a^2 + (1-a)^2)^k \equiv C\lambda_{\text{ess}}^{-k},$$

and

$$1/\lambda_{\text{ess}} = a^2 + (1-a)^2 \geq 1/\lambda_+ = a^a(1-a)^{1-a}, \quad (6.3)$$

with equality only in the case of uniform expansion, $a = \frac{1}{2}$ (and the identity maps $a = 0$, $a = 1$). Thus, the decay rate is **not** given by the inverse of the expanding Liapunov multiplier.

7. An Essential Decorrelation Radius above $1/\lambda$ and a Resonance

In this section, we somewhat generalize the construction of Section 4 and give an example of a map of the interval which has a resonance λ_r with $|1/\lambda_r| > 1/\lambda_{\text{ess}}$ and for which also $1/\lambda_{\text{ess}} > 1/\lambda$. This map is obtained as a perturbation of the Baladi map.

Consider four consecutive intervals I_1, \dots, I_4 in increasing order. We consider a map f of $I = I_1 \cup \dots \cup I_4$ into itself which is affine on each interval and satisfies the (topological) Markov property

$$\begin{aligned} f(I_1) &= I_2 \cup I_3, \\ f(I_2) &= I_4, \\ f(I_3) &= I_4, \\ f(I_4) &= I_1 \cup I_2 \cup I_3. \end{aligned}$$

We will denote by l_1, \dots, l_4 the lengths of the intervals, and by f_1, \dots, f_4 the absolute value of the slope of f in each interval. In order to ensure the above topological Markov property, some relations are required between the lengths and the slopes, namely

$$\begin{aligned} l_1 f_1 &= l_2 + l_3, \\ l_2 f_2 &= l_4, \\ l_3 f_3 &= l_4, \\ l_4 f_4 &= l_1 + l_2 + l_3. \end{aligned} \quad (7.1)$$

In order to ensure the differentiability of the map at the fixed point, we will assume that $f_3 = f_4$. Note that the Baladi map is the particular case when all slopes have equal modulus. If the slopes are given, the system (7.1) is composed of four homogeneous equations in four unknowns (the lengths). A necessary condition for the existence of a solution is the vanishing of the determinant of the associated matrix, namely

$$f_1 f_2 f_3^2 - f_1 f_2 - f_1 f_3 - f_2 - f_3 = 0. \quad (7.2)$$

Note that if all slopes are equal to λ , then (7.2) is equivalent to the equation $\lambda^4 - 2\lambda^2 - 2\lambda = 0$ for the Baladi map. We can also write the above relation as

$$f_1 = \frac{f_2 + f_3}{f_2 f_3^2 - f_2 - f_3}.$$

For any choice of f_2 and f_3 sufficiently close to λ , the above expression defines a number f_1 again close λ which is therefore larger than one. We can now choose $l_4 > 0$ and define

$$l_2 = \frac{l_4}{f_2}, \quad l_3 = \frac{l_4}{f_3}, \quad l_1 = \frac{l_2 + l_3}{f_1}.$$

The last equation of (7.1) is automatically satisfied and we have an obviously positive solution for the set of lengths which can be normalized to $\sum_i l_i = 1$.

Having constructed our maps, we now investigate the Perron-Frobenius (PF) operator on the set of functions which are piecewise constant on the atoms I_1, \dots, I_4 of the topological Markov partition. These functions are in bijection with four vectors, and it is easy to verify that the PF operator on these vectors is given by the matrix

$$P = \begin{pmatrix} 0 & 0 & 0 & \frac{1}{f_3} \\ \frac{1}{f_1} & 0 & 0 & \frac{1}{f_3} \\ \frac{1}{f_1} & 0 & 0 & \frac{1}{f_3} \\ 0 & \frac{1}{f_2} & \frac{1}{f_3} & 0 \end{pmatrix}.$$

The eigen-equation for this matrix is

$$\xi^4 - \frac{\xi^2}{f_3} \left(\frac{1}{f_2} + \frac{1}{f_3} \right) - \frac{\xi}{f_1 f_3} \left(\frac{1}{f_2} + \frac{1}{f_3} \right) = 0.$$

It follows easily from relation (7.2) that $\xi = 1$ is a solution. Since $\xi = 0$ is also a solution, and by continuity, for f_1, \dots, f_3 near λ , we must have a resonance (close to $\lambda_{r,\pm}$) given by the solutions of

$$\xi^2 + \xi + 1 - \frac{1}{f_3} \left(\frac{1}{f_2} + \frac{1}{f_3} \right) = 0.$$

Thus, we have constructed maps f with both a resonance (when the f_i are close to λ and chosen as indicated above) and with non-constant slope. From the discussion of Section 8 we will get immediately

Proposition 7.1. *There is a piecewise affine map of the interval which has a resonance, and for which the essential decorrelation radius is **larger** than $1/\lambda$, where λ is the Liapunov multiplier of the map (for the unique absolutely continuous invariant measure).*

Furthermore, by continuity, when we are close enough to the Baladi map, we find

$$|1/\lambda_r| > 1/\lambda_{\text{ess}} > 1/\lambda = 1/\lambda_{\text{min}}.$$

Resonance and sub-optimal decay. Using the above construction of a map with a resonance and non-constant slope, one can also construct a skew product in a similar way as in Section 5 and obtain a hyperbolic map *with a resonance* and with decay which is **slower** than $1/\lambda_{\text{min}}$.

8. Maps of the Interval with Essential Decorrelation Radius above $1/\lambda$

In this section we show that there are many maps of the interval (or the circle) for which the essential decorrelation radius is *larger* than $1/\lambda$, where λ is the Liapunov exponent (for the absolutely continuous invariant measure). Our results hold for maps with constant slope in each piece of the Markov partition. They are based on the work of Collet and Isola [4] who generalized the inequality (6.3) to more general 1-dimensional systems. For these there is an explicit formula both for the Liapunov multiplier and the essential spectral radius. For maps with constant slope in each piece the methods of [4] can be generalized to show that $\varrho_{\text{ess}} = \sigma_{\text{ess}}$. Therefore, the *equality between $1/\lambda$ and the essential decorrelation radius only holds when the map has the same (absolute value of the) slope everywhere*.⁸

The Liapunov multiplier for any invariant measure μ is given by

$$\lambda_\mu = \exp \left(\int d\mu(y) \log |f'(y)| \right). \quad (8.1)$$

One has also for almost every x with respect to the measure μ the more physical form

$$\lambda_\mu = \lim_{n \rightarrow \infty} \left(\prod_{j=0}^{n-1} |f'(f^j(x))| \right)^{1/n} = \lim_{n \rightarrow \infty} \exp \left(\frac{1}{n} \sum_{j=0}^{n-1} \log |f'(f^j(x))| \right). \quad (8.2)$$

The identity between (8.1) and (8.2) is based on the invariance and ergodicity of the measure μ . The results of [4] apply to 1-dimensional maps with the following properties: There is a finite set of disjoint open intervals I_1, \dots, I_ℓ whose closure forms a covering of $[0, 1]$, and the closure of $f(I_k)$ is $[0, 1]$ for every k . We also assume that f is \mathcal{C}^2 on each interval I_k with a \mathcal{C}^2 extension to the closure, and $\tau < |f'|_{I_k} < \tau'$ with $\tau > 1$.⁹ Ergodicity follows from the previous assumption, since the Lebesgue measure of $f^{-m}(I_j) \cup I_i$ is not zero for every i, j and any $m > 0$. In this case, there is a unique absolutely continuous invariant measure μ , and using (8.1) we will call $\lambda = \lambda_\mu$ for this measure.

There is detailed information on the essential spectrum:

Theorem 8.1. [4] *The essential spectral radius σ_{ess} , where \mathcal{L} is the Perron-Frobenius operator, is given by*

$$\sigma_{\text{ess}}(\mathcal{C}^1, \mathcal{L}) = \exp \left(\lim_{n \rightarrow \infty} \frac{1}{n} \log \int d\mu(x) |(f^n)'(x)|^{-1} \right). \quad (8.3)$$

As we have seen in Section 3, the relevant quantity is $\sigma_{\text{p-ess}}$ and not σ_{ess} . (See also [11] for an early reference.) In [4], it was shown that modulo a compact operator, each point of the open disk of radius ϱ_{ess} is an eigenvalue. Closer inspection of the argument used there shows that for maps with *constant slope* in each piece of the Markov partition the compact piece mentioned

⁸ To some extent these formulas can be generalized to hyperbolic SRB systems as we will show in Section 10.

⁹ Note that if all the slopes are positive, we are really talking about an ℓ -fold map of the circle to itself.

above has no effect, since the boundary terms in [4, proof of Lemma 5] do not contribute. Therefore, one finds

Theorem 8.2. *The essential point spectral radius $\sigma_{\text{p-ess}}$ for maps with constant derivative in each piece of the Markov partition $\sigma_{\text{p-ess}}$ is given by*

$$\sigma_{\text{p-ess}}(\mathcal{C}^1, \mathcal{L}) = \exp \left(\lim_{n \rightarrow \infty} \frac{1}{n} \log \int d\mu(x) |(f^n)'(x)|^{-1} \right). \quad (8.4)$$

Conjecture 8.3. *The identity (8.4) also holds for maps with variable slope.*

Remark. For the maps of Theorem 8.2, we therefore find the inequality:

$$\varrho_{\text{ess}}(\mathcal{C}^1, \mathcal{C}^1, U) \geq \exp \left(\lim_{n \rightarrow \infty} \frac{1}{n} \log \int d\mu(x) |(f^n)'(x)|^{-1} \right). \quad (8.5)$$

This means that for such maps the decay of correlations is indeed related to the Liapunov multiplier, and as we shall see below in Theorem 8.4, equality only holds if all the slopes are the same (in modulus).

Proof of Theorem 8.2. We start with a setting which is somewhat more general than the assumptions of Theorem 8.2. We consider a map f of the unit interval which is piecewise \mathcal{C}^2 expanding and Markov, namely there is a finite partition \mathcal{A} of the interval by subintervals such that on each atom f is monotone and \mathcal{C}^2 on the closure and such that the image of each atom is the union of atoms (modulo closure). We also assume that there is an integer k for which $|f^{k'}| > \zeta > 1$, and f is topologically mixing. Under these assumptions it is well known that f has a unique absolutely continuous invariant probability measure $d\mu = h dx$ which is ergodic with exponential decay of correlations (see [2] and references therein). It is also easy to verify that h is \mathcal{C}^1 on each atom of \mathcal{A} (with \mathcal{C}^1 extension to the closure).

We will consider the decay of correlations in the space X of functions which are \mathcal{C}^1 except maybe on the boundary of the atoms of \mathcal{A} . For Y , we use the space of \mathcal{C}^1 functions whose integral over each atom of \mathcal{A} is equal to zero. This insures that if $g \in Y$, we can find a function $v \in \mathcal{C}^2$ such that $v' = g$ and v vanishes on the boundary of the atoms of \mathcal{A} .

We will denote by \mathcal{A}_n the partition $\bigvee_0^n f^{-j} \mathcal{A}$. If u and v are \mathcal{C}^1 functions, we have

$$\int u \cdot v' \circ f^n d\mu = \int \frac{uh}{f^{n'}} \cdot v' \circ f^n f^{n'} dx = \sum_{I \in \mathcal{A}_{n-1}} \int_I \frac{uh}{f^{n'}} \cdot v' \circ f^n \cdot f^{n'} dx,$$

and integrating by parts we get

$$\begin{aligned} \int u \cdot v' \circ f^n d\mu = & - \sum_{I \in \mathcal{A}_{n-1}} \int_I \left(\frac{uh}{f^{n'}} \right)' v \circ f^n dx \\ & + \sum_{I \in \mathcal{A}_{n-1}} \frac{u(b_I^-)h(b_I^-)v(f^n(b_I^-))}{f^{n'}(b_I^-)} - \sum_{I \in \mathcal{A}_{n-1}} \frac{u(a_I^+)h(a_I^+)v(f^n(a_I^+))}{f^{n'}(a_I^+)}, \end{aligned} \quad (8.6)$$

where the boundary points a_I and b_I are defined for $I \in \mathcal{A}_{n-1}$ by

$$\bar{I} = [a_I, b_I].$$

Note that the two sequences (a_I) and (b_I) are identical except for the first and last terms, and they are given by all the preimages of order up to $n - 1$ of the boundaries of the atoms of \mathcal{A} . In particular, for each $I \in \mathcal{A}_n$, $f^n(a_I)$ and $f^n(b_I)$ belong to $\partial\mathcal{A}$.

We now use the assumption of Theorem 8.2, namely that f' is constant on the atoms of \mathcal{A} . This implies that $f^{n'}$ is constant on the atoms of \mathcal{A}_{n-1} . Therefore, the first term of (8.6) is given by

$$- \sum_{I \in \mathcal{A}_{n-1}} \int_I \left(\frac{uh}{f^{n'}} \right)' v \circ f^n dx = - \int \frac{(uh)'}{f^{n'}} v \circ f^n dx = - \int \mathcal{L}^n \left(\frac{(uh)'}{f^{n'}} \right) v dx,$$

where \mathcal{L} is the Perron-Frobenius operator associated to f . Note that when f is not constant on each atom of \mathcal{A} , another term appears involving the derivative of $f^{n'}$. This term corresponds to a compact operator and did not intervene in the computation of the essential spectral radius in [4]. It is not clear how such a term would influence the present computation.

To complete the proof of Theorem 8.2 one first applies Theorem 3.3 to the operator

$$U(g) = \mathcal{L} \left(\frac{g}{f'} \right)$$

in the space X' of functions which are piecewise \mathcal{C}^0 except possibly at the boundary of the atoms of \mathcal{A} , and Y' the space of \mathcal{C}^2 functions vanishing on $\partial\mathcal{A}$. One then applies Lemma 5 of [4] to conclude that each point in the open disk of the essential spectrum is an eigenvalue. (This Lemma has only been proven for full Markov maps but the proof easily extends to the general Markov case.) Note that since $h \neq 0$, multiplication by h is a bounded invertible operator in X . This provides the desired lower bound if there is only the first term in equation (8.6).

It remains to show that the last two terms are equal to zero, but this follows at once from the requirement $v(\partial\mathcal{A}) = 0$.

Remark. The r.h.s. of (8.5) is a special value of the function

$$F(\beta) = \lim_{n \rightarrow \infty} \frac{1}{n} \log \int d\mu(x) |(f^n)'(x)|^\beta,$$

at $\beta = -1$. The function F is convex, and its derivative at $\beta = 0$ is the Liapunov exponent, by (8.2) (for the measure μ after exchanging limits and derivatives which can be justified in that case):

$$\begin{aligned} \partial_\beta \lim_{n \rightarrow \infty} \frac{1}{n} \log \int d\mu(x) |(f^n)'(x)|^\beta \Big|_{\beta=0} &= \lim_{n \rightarrow \infty} \frac{1}{n} \log \int d\mu(x) \log |(f^n)'(x)| \\ &= \log \int d\mu(x) \log |f'(x)| = \log \lambda_\mu, \end{aligned}$$

by the invariance of the measure μ .

We next discuss the relation between λ_{ess} and λ . The function F is related to the pressure P of the observable $-\log |f'|$ (we refer to [14] for the definition) by the relation

$$F(\beta) = P((\beta - 1) \log |f'|), \quad (8.7)$$

since $P(-\log |f'|) = 0$ and F is defined with respect to the SRB measure μ . The quantity $1/\lambda_{\text{ess}}$ is bounded from above by:

$$1/\lambda_{\text{ess}} \leq \limsup_{n \rightarrow \infty} \sup_x \left| \frac{1}{(f^n)'(x)} \right|^{1/n} \leq \sup_x \left| \frac{1}{f'(x)} \right|.$$

And from below, it is bounded by $1/\lambda$, using Jensen's inequality

$$\int d\nu(x) \exp(u(x)) \geq \exp\left(\int d\nu(x) u(x)\right),$$

which holds for any probability measure ν .¹⁰

$$\begin{aligned} -\log \lambda_{\text{ess}} &= \lim_{n \rightarrow \infty} \frac{1}{n} \log \int d\mu(x) |(f^n)'(x)|^{-1} = \lim_{n \rightarrow \infty} \frac{1}{n} \log \int d\mu(x) \exp(-\log |(f^n)'(x)|) \\ &\geq \lim_{n \rightarrow \infty} \frac{1}{n} \log \exp\left(-\int d\mu(x) \log |(f^n)'(x)|\right) \\ &= \lim_{n \rightarrow \infty} \frac{1}{n} \left(-\int d\mu(x) \sum_{j=0}^{n-1} \log |f'(f^j(x))|\right) \\ &= -\int d\mu(x) \log |f'(x)| = -\log \lambda. \end{aligned} \quad (8.8)$$

Thus, we see from Theorem 8.1 that $1/\lambda_{\text{ess}} \geq 1/\lambda$.

On the other hand, if $|f'|$ is constant (and hence equal to λ), we always have $\lambda_{\text{ess}} = \lambda$, as one sees immediately from (8.3). More interestingly, the converse holds as well, modulo conjugations:

Theorem 8.4. *One has $\lambda = \lambda_{\text{ess}}$ if and only if there exists a Ψ of bounded variation for which*

$$\Psi \circ f(x) = T_\lambda \Psi(x), \quad (8.9)$$

where T_λ is a map with piecewise constant slope $\pm\lambda$. Furthermore, such a Ψ exists if and only if

$$\text{var}(u) \equiv \lim_{n \rightarrow \infty} \frac{1}{n} \int \left(\sum_{j=0}^{n-1} u \circ f^j \right)^2 d\mu \quad (8.10)$$

¹⁰ The third line uses again the invariance of the measure as in (8.2).

vanishes for $u = \log |f'| - \log \lambda$.

Another way to say this is:

Corollary 8.5. *One has $1/\lambda_{\text{ess}} > 1/\lambda$ if and only if $u = \log |f'| - \log \lambda$ fluctuates in the sense that $\text{var}(u) \neq 0$.*

Proof of Theorem 8.4. The anchoring point of the proof will be the variance. First of all, by [10] the limit in (8.10) always exists. Take now $u = \log |f'| - \log \lambda$, where $\lambda = \lambda_\mu$ is again the Liapunov multiplier. If $\text{var}(u) = 0$, then by a result of Rousseau-Egele [13, Théorème 2, Lemme 6] there exists a function w of bounded variation such that $u = w \circ f - w$ so that for our particular choice of u one has:

$$\log |f'| - \log \lambda = w \circ f - w ,$$

and exponentiating

$$|f'|e^{-w \circ f} = \lambda e^{-w} . \quad (8.11)$$

Note that $\exp(w)$ and $\exp(-w)$ are also of bounded variation. To keep the argument simpler, we will consider only the case when $f' > 0$ and work on the circle, and leave the details of the case where the sign of f' can change to the reader. In this case we find from (8.11) with $\Psi(x) = \int_0^x ds e^{-w(s)}$ the identities

$$(\Psi \circ f)' = f' e^{-w \circ f} = \lambda e^{-w} = \lambda \Psi' ,$$

and therefore $\Psi \circ f = T_\lambda \Psi$. So we conclude that if $\text{var}(u) = 0$ the required h exists, and furthermore, computing (8.8) in the coordinate system defined by Ψ , we see that $\lambda_{\text{ess}} = \lambda$.

If $\text{var}(u) > 0$, then, since F of (8.7) is a convex function and $F''(0) = \text{var}(\log |f'| - \log \lambda)$, we see that $\lambda_{\text{ess}} < \lambda$.

Finally, if $\lambda_{\text{ess}} < \lambda$ then clearly f cannot be conjugated to a function with constant slope, because in that case we would have $\lambda = \lambda_{\text{ess}}$ from (8.8).

This completes the proof of Theorem 8.4 (and also of Corollary 8.5). \square

9. Expanding Maps of Smooth Manifolds

The results of [4] have been extended to the multi-dimensional *expanding* case in the work of Gundlach and Latushkin [6]. Simplifying their statement for our purpose, they show the following

Theorem 9.1. *The Perron-Frobenius operator for a \mathcal{C}^2 expanding map ϕ of a smooth manifold \mathcal{M} , when acting on the space of \mathcal{C}^1 functions, has an essential spectral radius given by*

$$\sigma_{\text{ess}} = \exp \left(\sup_{\nu \in \text{Erg}} \left(h_\nu + \int_{\mathcal{M}} d\nu(x) \log(|\det D\phi(x)|^{-1}) - \chi_\nu \right) \right) , \quad (9.1)$$

where the sup is over all ergodic measures of the system, h_ν is the entropy of the map w.r.t. ν and χ_ν is the smallest Liapunov exponent of $D\phi$.¹¹

Remark. It should be noted that the hypotheses of Theorem 9.1, in particular the differentiability *everywhere* imply the existence of a finite Markov partition for the map. It seems that no general result is known in the absence of this condition.

Before we use (9.1) in more general contexts, we first show that one recovers indeed the formulas of Theorem 8.1 when one considers the case of an expanding map f of the circle. In that case, one takes $\phi = f$. For an invariant ergodic measure ν the integral in (9.1) equals

$$\lambda_\nu = - \int d\nu \log |f'|.$$

The unique Liapunov exponent of Df for the invariant ergodic measure ν is

$$\chi_\nu = \int \log |f'| d\nu.$$

From (9.1) we conclude the that

$$\sigma_{\text{ess}}(\mathcal{C}^1) = \exp \left(\sup_{\nu \in \text{Erg}} \{h_\nu - 2 \int \log |f'| d\nu\} \right).$$

On the other hand, by the variational principle (see Ruelle [14]) we have

$$\sup_{\nu \in \text{Erg}} \{h_\nu - 2 \int \log |f'| d\nu\} = P(-2 \log |f'|).$$

By (8.7), we have $P(-2 \log |f'|) = F(-1)$, which is (8.3), as asserted. \square

We now consider the more general examples covered by Theorem 9.1 and show that they indeed imply the same kind of lower bound. Note that by Ruelle's identity [14] one knows that the spectral radius σ_{sp} of the Perron-Frobenius operator on \mathcal{C}^0 (or \mathcal{C}^1 if the transformation is regular enough, since it equals the maximum positive eigenvalue) is

$$\sigma_{\text{sp}} = \exp \left(\sup_{\nu \in \text{Erg}} \left(h_\nu - \int_{\mathcal{M}} d\nu(x) \log |\det D\phi(x)| \right) \right). \quad (9.2)$$

When μ is the sole invariant measure which is absolutely continuous w.r.t. Lebesgue measure we see by the variational principle [14] that the argument of the exponential is the pressure and hence

$$\sigma_{\text{sp}} = \exp \left(h_\mu - \int_{\mathcal{M}} d\mu(x) \log |\det D\phi(x)| \right) = \exp P(-\log |\det D\phi|) = \exp(0) = 1. \quad (9.3)$$

¹¹ This is obtained from Eq.(1.2) in [6], where the authors allow a cocycle derived from a bundle automorphism in place of $D\phi$.

To get a lower bound on the essential spectral radius, we can plug in a particular measure in expression (9.1). Using the SRB measure μ , we get

$$\sigma_{\text{ess}} \geq e^{-\chi_\mu} .$$

Thus, we get in this case the following corollary from Theorem 9.1:

Corollary 9.2. *The essential spectral radius of the Perron-Frobenius operator for a \mathcal{C}^2 expanding map ϕ of a smooth manifold \mathcal{M} acting on the space of \mathcal{C}^1 functions satisfies*

$$\sigma_{\text{ess}} \geq e^{-\chi_\mu} ,$$

where χ_ν is the smallest Liapunov exponent of $D\phi$.

Question 9.3. *The relation with ϱ_{ess} remains open.*

10. A Conjecture and Some Steps Toward its Proof

The setting is now that of a smooth compact Riemannian manifold \mathcal{M} and a uniformly hyperbolic diffeomorphism f which is topologically mixing on the global attracting set Ω . We denote by μ the unique SRB measure (see [9]). We assume that the smallest Liapunov multiplier larger than 1 is associated with a space of dimension one.¹² Let g_1 and g_2 be two observables whose regularity will be fixed below. Let \mathcal{A} be a Markov partition of Ω , which is fine enough so that each atom can be foliated by *local* stable and unstable manifolds (see [9]). From now on when we speak of a local stable or unstable leaf, we always mean its restriction to an atom of the Markov partition. When speaking of a function on an atom A_0 of \mathcal{A} , we mean a function on the corresponding rectangle (the hull) on the ambient space \mathcal{M} .

We can write the correlation function

$$S_k = \int_{\mathcal{M}} d\mu g_1 \cdot g_2 \circ f^k = \int_{\mathcal{M}} d\mu g_1 \circ f^{-k} \cdot g_2 = \sum_{A \in \mathcal{A}} \int_A d\mu g_1 \circ f^{-k} \cdot g_2 . \quad (10.1)$$

We begin by rewriting (10.1) using the disintegration of the SRB measure with respect to the unstable foliations (see [9]). In other words, there is a measure N on the set \mathcal{W}^u of local unstable leaves, and for any $W \in \mathcal{W}^u$ there is a Hölder continuous positive function Θ_W on W such that

$$S_k = \sum_{A \in \mathcal{A}} \int_{A \cap \mathcal{W}^u} dN(W) \int_W dM_W g_1 \circ f^{-k} \cdot g_2 \cdot \Theta_W , \quad (10.2)$$

where dM_W is the Riemann measure on W , and where $A \cap \mathcal{W}^u$ is the subset of elements of \mathcal{W}^u contained in A . We finally define the density h on the leaves by

$$h(x) = \Theta_{W(x)}(x) . \quad (10.3)$$

¹² This means that the smallest positive Liapunov exponent is associated with a space of dimension one.

Note that the function h may not be defined on the whole phase space if we have a non trivial attractor (for example a strange attractor). However one can interpolate this function to a globally defined (strictly positive) Hölder continuous function, see *e.g.*, [12].

Remark. All our problems are related to this density¹³, because, as one can see from (10.2), the effective observable is not g_2 but $g_2 \cdot h$, and therefore smoothness requirements on g_2 alone do not suffice to make $g_2 \cdot h$ smooth enough.

Let δ be a positive constant whose value may vary with the context and system. By $\mathcal{C}^{1+\delta}$ we mean the class of \mathcal{C}^1 functions whose derivative is δ -Hölder continuous.

Assumption 10.1. *The foliation \mathcal{W}^u by the local manifolds W_{loc}^u is a $\mathcal{C}^{1+\delta}$ foliation of $\mathcal{C}^{1+\delta}$ manifolds and the field of one dimensional directions corresponding to the smallest expanding direction is Hölder continuous. Furthermore, h extends to a Hölder continuous function on \mathcal{M} and $\mathcal{C}^{1+\delta}$ in the unstable directions.*

We will need further assumptions on this foliation, see Fig. 8: Denote by \vec{t}_x the normalized tangent vector to $W^{u_{\min}}(x)$ at x , where $W^{u_{\min}}(x)$ is the (one-dimensional) manifold at x corresponding to the slowest expanding direction. Note that by our assumption it is Hölder in x .

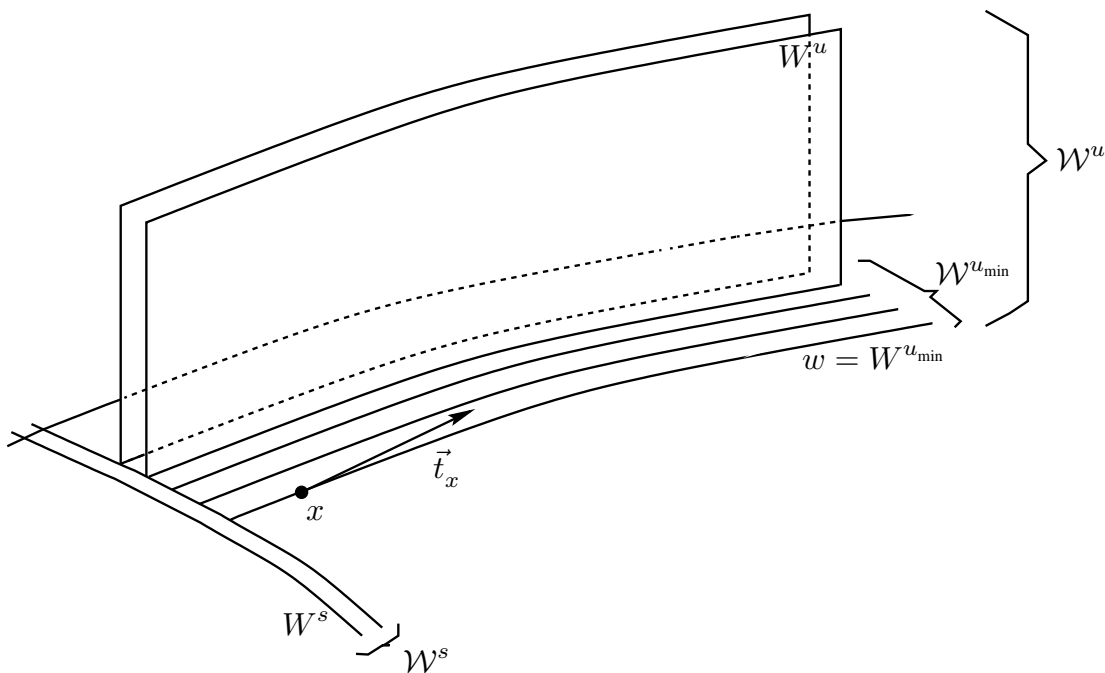

Fig. 8: The stable foliation \mathcal{W}^s (of dimension 1) and the unstable foliation \mathcal{W}^u (of dimension 2). Inside \mathcal{W}^u lie the one-dimensional leaves $\{w\}$ of the most slowly expanding direction, forming the family $\mathcal{W}^{u_{\min}}$. A leaf of this family is called w , with a “coordinate origin” x_w , (where $s = 0$), and the tangent vector $\vec{t}_{x(w,0)}$ (here shown at $s = 0$). We also labeled two leaves W^s and W^u corresponding to the respective foliations \mathcal{W}^s resp. \mathcal{W}^u .

¹³ Note that this density can be rough even if the invariant measure is the Lebesgue measure

Since the field of vectors $\{\vec{t}_x\}$ is covariant, we find (see [9]) that there is a Hölder continuous function φ (defined on \mathcal{M}) such that

$$Df_x \cdot \vec{t}_x = e^{\varphi(x)} \vec{t}_{f(x)}. \quad (10.4)$$

The function φ (whose average is positive) is the “local expansion rate” in the least unstable direction. Similarly, there is a Hölder continuous differential 1-form α such that for any x

$$\alpha_{f(x)} Df_x = e^{\varphi(x)} \alpha_x, \quad (10.5)$$

and

$$\alpha(\vec{t})_x \equiv \alpha_x(\vec{t}_x) = 1. \quad (10.6)$$

To make the argument more transparent, we will pursue it for the case of only 2 positive Liapunov exponents and leave the general case (with heavier notation) to the reader. We have already fixed a tangent field \vec{t} and a 1-form α which measure what happens in the “slow” unstable direction. Similarly, we now introduce a tangent field \vec{s} and a 1-form β which describe the other unstable direction. These are unique and Hölder continuous. The analogs of (10.4)–(10.6) are then

$$\begin{aligned} Df_x \cdot \vec{s}_x &= e^{\eta(x)} \vec{s}_{f(x)}, \\ \beta_{f(x)} Df_x &= e^{\eta(x)} \beta_x, \\ \beta(\vec{s})_x &\equiv \beta_x(\vec{s}_x) = 1. \end{aligned}$$

Assumption 10.2. *There are constants $\varepsilon_* > 0$ and C_* for which*

$$\sum_{j=0}^{k-1} \eta(f^{-j}(x)) \geq \sum_{j=0}^{k-1} \varphi(f^{-j}(x)) + k\varepsilon_* + \log C_*, \quad (10.7)$$

uniformly for sufficiently large k and for all x in \mathcal{M} .

This assumption implies $\alpha(\vec{s}) = \beta(\vec{t}) = 0$, because the Liapunov multipliers are different. In other words, the expansion rates η and φ are allowed to fluctuate, but there must remain a “gap” ε_* between them everywhere, and at large times. It would be interesting to understand to which extent (10.7) could be replaced by a condition on the Liapunov exponents alone. A stronger statement than (10.7) is to assume $\eta(x) > \varphi(x)$ for all x . This is in fact the “bunching condition,” since from the continuity of φ and η and the compactness of the manifold it follows that $\eta/\varphi > 1 + \varepsilon > 1$, uniformly in x .

Remark. This same condition ensures the Hölder continuity of the vector field tangent to $W^{u_{\min}}$ *i.e.*, it establishes one of the requirements of Assumption 10.1.

Remark. The Assumption 10.2 should be compared to the usual hyperbolicity conditions [7]. In that case, one requires for the stable directions a bound of the form $D(f^n)|_{E^s} \leq \lambda_-^n$ (in an adapted metric), and $D(f^{-n})|_{E^u} \leq \lambda_+^{-n}$ for the unstable directions, and then $\varepsilon_* = \log \lambda_+ - \log \lambda_-$. So for hyperbolicity, the strong form of (10.7) is being required.

The following result is formulated as a conjecture, since the arguments toward its proof are only sketched.

Conjecture 10.3. *Consider a dynamical system which is uniformly hyperbolic and has an SRB measure μ whose Liapunov multipliers are all different from 1. Assume it satisfies Assumption 10.1 and Assumption 10.2. For observables which are piecewise¹⁴ \mathcal{C}^1 in the unstable direction, and Lipschitz continuous in the stable directions, the essential decorrelation radius is at least $1/\lambda_{\min}$, where λ_{\min} is the smallest Liapunov multiplier greater than 1 (as in Eq.(2.3)). Furthermore, the essential spectral radius is strictly larger than $1/\lambda_{\min}$ whenever the system is not smoothly¹⁵ conjugated to a system whose differential is a constant function in the direction corresponding to λ_{\min} .*

Question 10.4. *We expect the conclusions to hold for observable which are piecewise \mathcal{C}^1 in all directions.*

Sketch of proof of Conjecture 10.3. We first define the spaces X and Y for which can prove the assertion of Conjecture 10.3. The space X is formed by functions obtained as follows: Select an atom A_0 of the partition \mathcal{A} . Choose a fixed vector field V_{A_0} which is defined in a neighborhood of A_0 and which is tangent at every $x \in A_0$ to $W_{\text{loc}}^u(x)$, and which does not vanish on the hull of A_0 . This is possible because these manifolds are $\mathcal{C}^{1+\delta}$ in x . We also assume that this vector field has zero divergence in the unstable directions.

We further choose a function v which is \mathcal{C}^2 in the hull (in \mathcal{M}) of A_0 , vanishing on the stable boundaries of A_0 .

The observables g_2 in X are defined by the equation

$$g_2 = \frac{1}{h} dv(V_{A_0}),$$

where h is defined in (10.3), and is extended to a positive function on the hull of A_0 . By our above assumptions, g_2 is \mathcal{C}^1 in the unstable directions and δ -Hölder continuous in the stable directions. As we vary A_0 and v over all possible choices, we obtain a set X_0 of functions. Since $v \in \mathcal{C}^2$, the map $v \mapsto dv(V_{A_0})$ has closed kernel, and this induces a topology on the image. If we divide by h , things do not change, and we have a topology on the functions g_2 . Varying A_0 this construction makes X_0 to a Banach space X . (This space has a topology which is somewhat finer than the $\mathcal{C}^{1-\delta}$ -Hölder topology considered above.)

We next construct the space Y . Fix an atom A_0 . Let j be a function on the hull of A_0 which is \mathcal{C}^0 along the unstable directions and δ -Hölder in the stable ones. Define g_1 by the equation

$$dg_1(\vec{t})_x = j(x). \quad (10.8)$$

Arguing as in the construction of X , we obtain Y by varying A_0 and j , and inducing the topology.

¹⁴ In fact, the class of observables we really consider is quite complicated, as it will turn out to be a complicated subset of \mathcal{C}^1 . See below for a precise description.

¹⁵ For more subtle aspects of the conjugation, see Theorem 8.4.

Finally, the operator U is the Koopman operator of the map f , that is

$$(Ug)(x) = g(f(x)). \quad (10.9)$$

Now that the spaces are in place, we can work on (10.2). Take g_1 and g_2 in a piece A_0 of the partition. We integrate by parts in (10.2) in each W separately. Since V is divergence-free and v vanishes at the stable boundary of A_0 , we obtain

$$\begin{aligned} \int_W dM_W g_1 \circ f^{-k} \cdot g_2 \cdot \Theta_W &= \int_W dM_W g_1 \circ f^{-k} \cdot dv(V) \\ &= - \int_W dM_W d(g_1 \circ f^{-k})(V) \cdot v \\ &= - \int_W dM_W (dg_1) \circ f^{-k} \cdot (D_x f^{-k}(V)) \cdot v. \end{aligned} \quad (10.10)$$

Decomposing in the unstable directions we get

$$\begin{aligned} dg_{1f^{-k}(x)}(D_x f^{-k}(V)) &= dg_1(\vec{t})_{f^{-k}(x)} \cdot \alpha(V)_x \cdot e^{-\sum_{j=0}^{k-1} \varphi(f^{-j}(x))} \\ &\quad + dg_1(\vec{s})_{f^{-k}(x)} \cdot \beta(V)_x \cdot e^{-\sum_{j=0}^{k-1} \eta(f^{-j}(x))}. \end{aligned} \quad (10.11)$$

Clearly, Assumption 10.2 implies a uniform bound for (10.11):

$$\begin{aligned} dg_{1f^{-k}(x)}(D_x f^{-k}(V)) &= dg_1(\vec{t})_{f^{-k}(x)} \cdot \alpha(V)_x \cdot e^{-\sum_{j=0}^{k-1} \varphi(f^{-j}(x))} \\ &\quad + \mathcal{O}(e^{-\varepsilon_* k - \sum_{j=0}^{k-1} \varphi(f^{-j}(x))}), \end{aligned} \quad (10.12)$$

so that the faster rate η has been eliminated from the discussion. Inserting in (10.10), we find

$$S_k = - \int d\mu dg_1(\vec{t}) \circ f^{-k} e^{-\tilde{\Sigma}_k} \tilde{g}_2 + \mathcal{O}(e^{-\varepsilon_*} Z_k), \quad (10.13)$$

(as $k \rightarrow \infty$), where

$$\tilde{\Sigma}_k(x) = \sum_{j=0}^{k-1} \varphi^u(f^{-j}(x)), \quad \tilde{g}_2(x) = \frac{v(x)}{h(x)}, \quad Z_k = \int d\mu e^{-\tilde{\Sigma}_k},$$

by the invariance of the measure, we find

$$S_k = - \int d\mu \tilde{g}_1 e^{-\Sigma_k} \tilde{g}_2 \circ f^k + \mathcal{O}(e^{-\varepsilon_*} Z_k), \quad (10.14)$$

where

$$\Sigma_k(x) = \sum_{j=0}^{k-1} \varphi^u(f^j(x)), \quad \tilde{g}_1(x) = dg_1(\vec{t})_x.$$

We now use the thermodynamic formalism [3]. Define the Hölder continuous function φ^u by $\varphi^u = -\log \det J^u$ where J^u is the Jacobian matrix in the unstable bundle.¹⁶ Recall that under our assumptions there is a homeomorphism π conjugating the dynamical system f on the attractor to a subshift \mathcal{S} of finite type. The SRB measure μ is then transformed to a Gibbs state γ with the Hölder continuous potential $\varphi^u \circ \pi$. We get for the first term on the right hand side of (10.14):

$$D_k = - \int d\gamma \tilde{g}_1 \circ \pi e^{-\Sigma_k \circ \pi} \cdot \tilde{g}_2 \circ \pi \circ \mathcal{S}^k . \quad (10.15)$$

Define an operator \mathcal{T} by

$$\mathcal{T}\psi = e^{-\varphi^u \circ \pi} \tilde{\psi} \circ \mathcal{S} ,$$

where ψ is a function on the shift space. Then (10.15) becomes

$$D_k = - \int d\gamma (\mathcal{T}^*)^k (\tilde{g}_1 \circ \pi) \cdot \tilde{g}_2 \circ \pi . \quad (10.16)$$

We now apply Theorem 3.3 with $X' = Y' = \mathcal{C}^0$ and $U' = \mathcal{T}^*$ and we find $\varrho_{\text{ess}}(X, Y, U) = \varrho_{\text{ess}}(X', Y', U') \geq \sigma_{\text{p-ess}}(X', U')$. It remains to give a lower bound on $\sigma_{\text{p-ess}}(X', U')$ in terms of the pressure. Using a well-known device [2, Lemma 1.3], we can conjugate \mathcal{T} to an operator \mathcal{T}_+ defined by

$$\mathcal{T}_+\psi = e^{-\varphi_+^u \circ \pi} \tilde{\psi} \circ \mathcal{S} ,$$

where $\varphi_+^u \circ \pi$ depends only on the future, *i.e.*, φ_+^u is constant on the stable (local) leaves. Note now that when \mathcal{T}_+^* acts on a function ψ_+ which depends only on the *future*, it is given by

$$\mathcal{T}_+^* \psi_+ = \frac{1}{\phi_+} \mathcal{L}(\phi_+ e^{-\varphi_+^u \circ \pi} \psi_+) , \quad (10.17)$$

where \mathcal{L} is the Perron-Frobenius operator and ϕ_+ satisfies

$$\mathcal{L}\phi_+ = \phi_+ .$$

The eigenvalue above is 1 because we are dealing with an SRB measure, and the eigenvector is unique. We now see that $\sigma_{\text{p-ess}}(X', U')$ is bounded below by the essential point spectral radius of $\mathcal{L} \exp(-\varphi_+^u \circ \pi)$. One now introduces the pressure

$$P(\varphi^u - h) \equiv \lim_{k \rightarrow \infty} \frac{1}{k} \log \int_{\mathcal{M}} d\mu(x) e^{-\sum_{j=0}^{k-1} h(f^{-j}(x))} ,$$

where $P(\varphi^u) = 0$, because we are dealing with an SRB measure. Then, it is known [4], [2, Theorem 1.5.7] that every point in the open disk of radius $\exp(P(2\varphi^u))$ is an eigenvalue of $\mathcal{L} \exp(-\varphi_+^u \circ \pi)$. Since $\exp(P(2\varphi^u)) > 1/\lambda_{\min}$, the desired inequality follows. This completes the sketch of the proof of Conjecture 10.3. \square

¹⁶ In principle, for the case of 2 positive Liapunov exponents, φ^u can be computed from $\varphi, \eta, \vec{t}, \vec{s}, \alpha$, and β .

10.1. Sufficient Conditions

We next address the question of sufficient conditions for Assumption 10.1 and Assumption 10.2 to hold. A typical such condition is the bunching condition from [9, p. 602], or, the concept of domination developed in [7]. Consider a point x and write Df_x in matrix form

$$Df_x = \begin{pmatrix} A_x & 0 \\ 0 & D_x \end{pmatrix},$$

with the blocks corresponding to unstable and stable subspaces, respectively. We define

$$\lambda_x = \|D_x\|, \quad \mu_x = (\|A_x^{-1}\|)^{-1}.$$

Let ν_x be the inverse of the Lipschitz constant for f^{-1} :

$$\nu_x = \frac{1}{L(f^{-1})_x}, \quad L(g)_x \equiv \sup_{|x-y|<\varepsilon} \frac{|g(x) - g(y)|}{|x - y|},$$

with $\varepsilon > 0$ some small constant.

One defines the bunching constant by

$$B^u(f) = \inf_x \frac{\log \mu_x - \log \lambda_x}{\log \nu_x}.$$

Theorem 10.5. *Let f be a \mathcal{C}^3 map of the manifold \mathcal{M} which gives rise to an Axiom A system whose unstable manifolds W^u are \mathcal{C}^2 and the stable ones, W^s , are \mathcal{C}^1 . Assume that the Liapunov multipliers of f satisfy the following conditions:*

- 1) *The smallest Liapunov multiplier above 1 is λ_{\min} and the corresponding dimension is 1.*
- 2) *There are no Liapunov multipliers equal to 1.*
- 3) *The (multidimensional version of) inequality (10.7) holds.*
- 4) *The bunching constant satisfies*

$$B^u(f) > 1, \tag{10.18}$$

and for the inverse map

$$B^u(f^{-1}) > 1. \tag{10.19}$$

Then Assumption 10.1 and Assumption 10.2 hold.

Proof. The proofs of all assertions except for the smoothness of h can be found in [9, Chapter 19, p607].

So it remains to prove the differentiability of h . We recall that using a base point x_W on the leaf W , we have for the density of the SRB measure on the unstable manifold $W^u(x)$ of any $x \in W$:

$$h(x) = \prod_{j=0}^{\infty} e^{\varphi^u(f^{-j}(x)) - \varphi^u(f^{-j}(x_W))}$$

where x_W is a reference point chosen once and for all on $W^u(x)$. When varying x along an unstable leaf, the reference point does not change. Each term in the above product is differentiable in the unstable direction, and the regularity properties of h follow easily by checking the convergence of the series. The Hölder continuity of h follows by standard arguments from the Hölder continuity of the stable foliation. \square

Remark. In the case of skew products of Baladi maps, it is easy to verify that the local stable manifolds are vertical segments. Because of the local flatness of the invariant measure of the one dimensional system, it follows from the explicit expression of the map that the differential is diagonal. This implies that the field of unstable directions is horizontal (as well as the local unstable manifolds). This implies that Θ_w is constant on the local unstable manifold. By changing if necessary the transverse measure, we can assume that $\Theta_w = 1$. Therefore, if v is a C^2 function with compact support contained in an atom of the Markov partition, the observable g_2 defined as above is C^1 and we can apply the above technique. Note that in this case Assumption 10.1 is violated since the map is area preserving.

10.2. An Example

We construct an example where all the above assumptions are satisfied. This example is a generalization of the solenoid and can also be viewed as a skew product. First of all, let $p > 6$ be an odd integer. Let ℓ be that solution of the equation

$$\ell^2(1 + \cos(2\pi/p)) - 4\ell + 2 = 0,$$

which is less than one. Let $r = 1 - \ell$. Note that for p large, we have $r \approx \pi/p$. Let q be another odd integer with $p > q > 4$. It is easy to verify that the spheres of radius r centered at points with polar coordinates $(\ell, 2k\pi/p, 2m\pi/q)$ with $0 \leq k < p$ and $0 \leq m < q$ are mutually disjoint. We now define a map f of $\mathbf{M} = \mathbf{T}^2 \times \mathbf{B}^3$ into itself (\mathbf{T}^2 the two dimensional torus and \mathbf{B}^3 the three dimensional unit ball) by

$$f(\vartheta, \varphi, (x, y, z)) = (p\vartheta, q\varphi, rx + \ell \cos \vartheta \cos \varphi, ry + \ell \sin \vartheta \cos \varphi, rz + \ell \sin \varphi),$$

where the angles are modulo 2π and we use Cartesian coordinates on \mathbf{B}^3 . It is left to the reader to verify that because of our choice of ℓ and r the map is injective. It is obviously a skew product above the map of the torus $(\vartheta, \varphi) \mapsto (p\vartheta, q\varphi)$ which is ergodic and mixing for the Lebesgue measure.

Remark. More balls can be packed and also balls with larger radius using a Peano surface for the position of the centers instead of the sphere of radius ℓ as above.

The differential of f is given by

$$Df = \begin{pmatrix} p & 0 & 0 & 0 & 0 \\ 0 & q & 0 & 0 & 0 \\ \mathcal{X} & \mathcal{X} & r & 0 & 0 \\ \mathcal{X} & \mathcal{X} & 0 & r & 0 \\ \mathcal{X} & \mathcal{X} & 0 & 0 & r \end{pmatrix},$$

and

$$Df^{-1} = \begin{pmatrix} 1/p & 0 & 0 & 0 & 0 \\ 0 & 1/q & 0 & 0 & 0 \\ -\mathcal{X}/(rp) & -\mathcal{X}/(rq) & 1/r & 0 & 0 \\ -\mathcal{X}/(rp) & -\mathcal{X}/(rq) & 0 & 1/r & 0 \\ -\mathcal{X}/(rp) & -\mathcal{X}/(rq) & 0 & 0 & 1/r \end{pmatrix},$$

where \mathcal{X} denotes various quantities of order one.

We now verify the bunching conditions. First of all, the stable bundle is obviously obtained by setting the first two components of a tangent vector equal to zero. Therefore, $\lambda = r$, and also the stable manifold of a point $(\vartheta, \varphi, x, y, z)$ is the set of points with the same angles ϑ and φ .

The unstable bundle is not so trivial. As in [9], the unstable bundle is obtained as a graph above the space of vectors whose last two coordinates are equal to zero. In other words, for every point $P \in \mathbf{M}$, there is a linear operator L_P from \mathbf{R}^2 to \mathbf{R}^3 such that the unstable subspace at P is the set

$$E^u(P) = \{(z, L_P z) \mid z \in \mathbf{R}^2\},$$

with the canonical identifications. From the equation satisfied by L_P (see [9]) it follows easily that

$$\sup_{P \in \mathbf{M}} \|L_P\| \leq \mathcal{O}(1)q^{-1}.$$

It then follows that $\mu^{-1} = q^{-1}(1 + \mathcal{O}(1)q^{-1})$. Finally ν^{-1} is at most the sup norm of Df^{-1} and we get $\nu^{-1} \leq r^{-1} + \mathcal{O}(1)r^{-1}q^{-1}$. Recalling that $r \approx \pi q^{-1}$ for large q , we get

$$\lambda\mu^{-1}\nu^{-2} \leq rq^{-1}r^{-2}(1 + \mathcal{O}(1)q^{-1}) \leq \pi^{-1}(1 + \mathcal{O}(1)q^{-1}) < 1,$$

for q large enough, namely the unstable bundle is even \mathcal{C}^2 (we only require $\mathcal{C}^{1+\alpha}$ for some $\alpha > 0$).

The stable bundle is obviously infinitely regular but we can check the bunching condition for the inverse. We obtain $\lambda = q^{-1} + \mathcal{O}(1)r^{-1}q^{-2}$, $\mu^{-1} = r$, $\nu^{-1} = p + \mathcal{O}(1)$. We get

$$\lambda\mu^{-1}\nu^{-\alpha} \leq q^{-1}rp^\alpha(1 + \mathcal{O}(1)q^{-1}) = \pi q^{-2}p^\alpha(1 + \mathcal{O}(1)q^{-1}),$$

and this is smaller than one for q large enough if $\alpha < 2$ and p is not much larger than q . In other words, we can construct examples with the stable bundle $\mathcal{C}^{1+\sigma}$ for any $0 < \sigma < 1$.

Finally we have to check the condition $\inf \eta/\varphi > 1$. In the above example this is made simpler by the observation that the set of tangent vectors with first coordinate equal to zero is covariant. The same is true for the set of vectors with second coordinate equal to zero. Therefore, the two invariant bundles are graphs. The largest one is a set of vectors

$$\{(s, 0, u_1(P)s, v_1(P)s, w_1(P)s) \mid s \in \mathbf{R}\}$$

and the lowest one

$$\{(0, s, u_2(P)s, v_2(P)s, w_2(P)s) \mid s \in \mathbf{R}\}.$$

The six functions u_i, v_i, w_i satisfy the usual coherence equations, and it follows easily that they are all uniformly bounded by $\mathcal{O}(1)q^{-1}$. It follows easily that

$$\eta \geq p + \mathcal{O}(1)pq^{-1} \quad \text{and} \quad \varphi \leq q + \mathcal{O}(1),$$

and our condition is satisfied if $p/q > 1 + \mathcal{O}(1)q^{-1}$ and q is large enough.

Appendix

We give here the proof of Lemma 3.4. The l.h.s. of (3.5) is ϱ_{ess} . The r.h.s. will be called $\bar{\varrho}_{\text{ess}}$. We have obviously $\bar{\varrho}_{\text{ess}} \geq \varrho_{\text{ess}}$. To prove the converse inequality, let $\varepsilon > 0$. From the definition of ϱ_{ess} we can find two subspaces M and M' of finite codimension such that

$$\limsup_{n \rightarrow \infty} \left(\sup_{\substack{x \in M \\ y \in M'}} \frac{|\langle y, U^n x \rangle|}{\|y\| \|x\|} \right)^{1/n} < \varrho_{\text{ess}} + \frac{\varepsilon}{3}.$$

This implies that there is an integer N such that for any $n > N$ we have

$$\left(\sup_{\substack{x \in M \\ y \in M'}} \frac{|\langle y, U^n x \rangle|}{\|y\| \|x\|} \right)^{1/n} < \varrho_{\text{ess}} + \frac{\varepsilon}{2},$$

which is equivalent to

$$\sup_{\substack{x \in M \\ y \in M'}} \frac{|\langle y, U^n x \rangle|}{\|y\| \|x\|} < \left(\varrho_{\text{ess}} + \frac{\varepsilon}{2} \right)^n.$$

Observe that the spaces \bar{M} and \bar{M}' which are the closures of M and M' are also of finite codimension. Moreover, for each n , we can find $x \in \bar{M}$ and $y \in \bar{M}'$, both of norm 1 such that

$$\frac{|\langle y, U^n x \rangle|}{\|y\| \|x\|} \geq \sup_{\substack{x \in \bar{M} \\ y \in \bar{M}'}} \frac{|\langle y, U^n x \rangle|}{\|y\| \|x\|} - \left((\varrho_{\text{ess}} + \varepsilon)^n - (\varrho_{\text{ess}} + \varepsilon/2)^n \right).$$

If $x \notin M$ or $y \notin M'$ or both, we can find two sequences $(x_j) \subset M$ and $(y_j) \subset M'$ converging to x and y respectively. Therefore,

$$\frac{|\langle y, U^n x \rangle|}{\|y\| \|x\|} = \lim_{j \rightarrow \infty} \frac{|\langle y_j, U^n x_j \rangle|}{\|y_j\| \|x_j\|} \leq \sup_{\substack{x \in M \\ y \in M'}} \frac{|\langle y, U^n x \rangle|}{\|y\| \|x\|}.$$

This implies for any $n > N$

$$\sup_{\substack{x \in \bar{M} \\ y \in \bar{M}'}} \frac{|\langle y, U^n x \rangle|}{\|y\| \|x\|} \leq (\varrho_{\text{ess}} + \varepsilon)^n.$$

Since ε is arbitrary, the result follows.

Acknowledgments. We thank V. Baladi and D. Ruelle for essential help in guiding us through the literature. We have also profited from helpful discussions with Ch. Bonatti, M. Viana, and A. Wilkinson. This work was partially supported by the Fonds National Suisse.

References

- [1] V. Baladi. Unpublished (1989).
- [2] V. Baladi. *Positive transfer operators and decay of correlations*, volume 16 of *Advanced Series in Nonlinear Dynamics* (River Edge, NJ: World Scientific Publishing Co. Inc., 2000).
- [3] R. Bowen. Equilibrium States and the Ergodic Theory of Anosov Diffeomorphisms. *Springer Lect. Notes in Math.* **470** (1975), Berlin–Heidelberg–New York.
- [4] P. Collet and S. Isola. On the essential spectrum of the transfer operator for expanding Markov maps. *Comm. Math. Phys.* **139** (1991), 551–557.
- [5] D. E. Edmunds and W. D. Evans. *Spectral Theory and Differential Operators* (New York: Oxford University Press, 1987).
- [6] V. Gundlach and Y. Latushkin. A sharp formula for the essential spectral radius of Ruelle’s operator on smooth and Hölder spaces. *Ergodic Theory Dynam. Systems* **23** (2003), 175–191.
- [7] M. Hirsch, C. Pugh, and M. Shub. Invariant manifolds. *Springer Lect. Notes in Math.* **583** (1977), Berlin–New York.
- [8] T. Kato. *Perturbation Theory for Linear Operators* (Springer-Verlag, Berlin, 1984). Second corrected printing of the second edition.
- [9] A. Katok and B. Hasselblatt. *Introduction to the modern theory of dynamical systems*, volume 54 of *Encyclopedia of Mathematics and its Applications* (Cambridge: Cambridge University Press, 1995). With a supplementary chapter by Katok and Leonardo Mendoza.
- [10] G. Keller. Ergodicité et mesures invariantes pour les transformations dilatantes par morceaux d’une région bornée du plan. *C.R. Acad. Sci. Paris Sér. A-B.* **289** (1979), A625–A627.
- [11] G. Keller. On the rate of convergence to equilibrium in one-dimensional systems. *Comm. Math. Phys.* **96** (1984), 181–193.
- [12] P. Mattila. *Geometry of sets and measures in Euclidean spaces*, volume 44 of *Cambridge Studies in Advanced Mathematics* (Cambridge: Cambridge University Press, 1995). Fractals and rectifiability.
- [13] J. Rousseau-Egele. Un théorème de la limite locale pour une classe de transformations dilatantes et monotones par morceaux. *Ann. Probab.* **11** (1983), 772–788.
- [14] D. Ruelle. *Thermodynamic Formalism* (Addison Wesley, Reading MA, 1978).
- [15] D. Ruelle. Resonances of chaotic dynamical systems. *Phys. Rev. Lett.* **56** (1986), 405–407.
- [16] D. Ruelle. Resonances for Axiom A flows. *J. Differential Geom.* **25** (1987), 99–116.
- [17] L.-S. Young. Recurrence times and rates of mixing. *Israel. J. Math.* **110** (1999), 153–188.