

HIGH ENERGY PHYSICS INSTITUTE
TBILISI I. JAVAKHISHVILI STATE UNIVERSITY

Licensed as a Manuscript

L. Kharkhelaury

**Study of Multiparticle Azimuthal Correlations in Central
Nucleus-Nucleus Collisions at energy of 3.7 GeV per nucleon**

01.04.16-Physics of Atoms, Atomic
Nuclei and Elementary Particles

A b s t r a c t o f D i s s e r t a t i o n
For the Fulfilment of Scientific Degree of the Candidate
in Physical and Mathematical Sciences

TBILISI, 2001

**The research is fulfilled in High Energy Physics Institute of
Tbilisi State University**

Supervisors:

L. CHKHAIDZE

Candidate of Physical and Mathematical Sciences

T. DJOBAVA

Candidate of Physical and Mathematical Sciences

Referees:

V. GARSEVANISHVILI

Doctor of Physical and Mathematical Sciences, Professor

01.04.16-Physics of Atoms, Atomic Nuclei and Elementary Particles

M. SVANIDZE

Candidate of Physical and Mathematical Sciences

01.04.16-Physics of Atoms, Atomic Nuclei and Elementary Particles

Scientific Secretary of the Dissertation Council,
Doctor of Physical and Mathematical Sciences

T. KERESSELIDZE

Subject of the Research Work. Relativistic nucleus–nucleus collisions are very well suited for investigation of excited nuclear matter properties under extreme conditions of high densities and high temperatures, which are the subject of intense studies both experimentally and theoretically. A new collective phenomena have been revealed in high energy heavy ion collisions, which allow to study the nuclear equation of state (EOS) and offers an unique information about the possible phase transition in the nuclear matter as well.

The experimental discovery of such states is impossible without understanding the mechanism of collisions and studying the characteristics of multiparticle production in nucleus–nucleus interactions. During last 10-15 years several theoretical models have been proposed for the study of nucleus-nucleus collisions at high energy. It is assumed that, the intranuclear cascade model (CAscade Intranuclear Model Made in Rossendorf - CASIMIR) and Quark Gluon String Model (QGSM) allow to investigate hadron-nuclear, hadron-nucleus and nucleus–nucleus collisions at wide energy interval and especially in the range of intermediate energy $\sqrt{s} \leq 4$ GeV).

In order to study the dynamics of the relativistic nucleus-nucleus collisions in the series of experiments the inclusive spectra of kinematical variables have been obtained for secondary protons and mesons. It is interesting to study the correlation between Lorenz invariant variables, such as the rapidity Y and transverse momentum P_T of the produced particles. Interesting information about the collision process and its space-time evolution can be obtained from the analysis of secondary particles angular distributions with the aim to determine the degree of anisotropy in particles emission. It is also important to investigate the energetic spectra of secondary particles at different intervals of emission angle θ_{lab} .

In the energy range of (0.5 - 10) GeV/nucleon the nuclear matter is compressed and heated more than at lower beam energies. Two different signatures of collective flow have been predicted by nuclear shock wave models and ideal fluid dynamics: 1) the bounce-off of the compressed matter in the reaction plane and 2) the squeeze-out of the participant matter out of the reaction plane. Collective flow has been already observed for protons, light nuclei, pions, kaons and (Λ -hyperons in nucleus–nucleus collisions at the energies: of (0.1-1.8) GeV/nucleon at BEVALAC (Lawrence Berkeley Laboratory - USA), GSI/SIS (Darmstadt - Germany), 3.7 GeV/nucleon at Dubna (Joint Institute Nuclear Research - Russian), 2 - 14 GeV/nucleon AGS BNL (Brookhaven National Laboratory - USA) and 60 and 200 GeV/nucleon at CERN SPS (European Organization for Nuclear Research - Switzerland), and more recently by the STAR and PHENIX at RHIC BNL at $\sqrt{S_{NN}} = 130$ GeV/nucleon. Many different methods have been proposed for the study of the flow effects in relativistic nuclear collisions, of which the most commonly used are the directed transverse momentum analysis technique developed by P. Danielewicz and G. Odyniec and the method of the Fourier expansion of azimuthal distributions proposed by Demoulin et al. and Voloshin and Zang.

The investigation of the collective effects can be also studied in multiparticle azimuthal

correlations, because it gives the information about space-time evolution of the colliding system. In order to study these correlations between the protons and between the π^- mesons, the phase space can be divided into two hemispheres. The division can be performed by use of the rapidity and by the emission angle - the forward and backward emitted particles and by energy - the slow and fast particles as well. The azimuthal correlations have been already observed between protons and between pions in nucleon-nucleus and nucleus-nucleus collisions at energies of (0.4-1.8) GeV/nucleon at BEVALAC, 3.7 GeV/nucleon at Dubna and 60 and 200 GeV/nucleon at CERN SPS.

Aims of the Thesis.

- The study of the properties of π^- mesons produced in Mg-Mg collisions at energy of $E=3.7$ GeV/nucl at a SKM-200-GIBS set-up of JINR/DUBNA. Investigations of the correlation between Lorentz invariant variables: the rapidity Y and the transverse momentum P_T . The analysis of angular distribution of π^- mesons and the study of the dependence of π^- mesons emission anisotropy coefficient a on the kinetic energy. Investigation of emitted π^- mesons energetic spectra in different intervals of emission angle θ_{lab} in the laboratory and centre of mass systems (c.m.s.).
- Investigation of collective flow effects of π^- mesons produced in central C-Ne, Mg-Mg, C-Cu and O-Pb collisions at energy of $E=3.7$ GeV/nucl by use of transverse momentum technique of P. Danielewicz and G. Odyniec. The study of the dependence of the flow parameter F , as the slope at midrapidity, on the target mass numbers (A_T).
- Investigation of the collective effects by the multiparticle azimuthal correlations between protons and between pions in central C-Ne, Mg-Mg, C-Cu and O-Pb collisions. The study of the dependence of the correlation function on the angles $\Delta\varphi$ between the summed transverse vectors for particles emitted in the forward and backward hemispheres.
- Comparison of the obtained experimental results with predictions of intranuclear cascade model (CASIMIR) and Quark Gluon String Model (QGSM).

Scientific Novelty.

- A detailed study of pion production in central Mg-Mg collisions have been carried out: a) Correlations between P_T and Y have been studied; b) The anisotropy coefficient a of π^- mesons has been obtained from the angular distributions of pions. Its dependence on E_{kin}/E_{kin}^{max} in the c.m.s. has been studied, c) The dependence of the energy spectra of π^- mesons emitted in an angular interval of $0^\circ \leq \theta_{lab} \leq 180^\circ$ in the laboratory system and $\theta_{C.M.S.} = 90^\circ \pm 10^\circ, 90^\circ \pm 20^\circ$ emission angles in c.m.s. on A_P, A_T have been investigated for Mg-Mg, He(Li, C), C-Ne, C-Cu, (C,O)Pb collisions. The values of fireball model parameters, the temperature E_o^\perp and velocity β of the cluster formed during the collisions, which is emitting π^- mesons have been defined. The obtained results have been compared with the predictions of CASIMIR.
- Using transverse momentum analysis method of P. Danielewicz and G. Odyniec for the first time the reaction plane has been defined by pions only and the collective flow effects of

π^- mesons produced in central Mg-Mg collisions have been performed. The similar investigation for pions produced in central C-Ne, C-Cu and O-Pb collisions has been carried out. The dependence of flow parameter F on A_T -target mass numbers has been obtained. The obtained results have been compared with the predictions of QGSM.

- The investigation of the multiparticle azimuthal correlations between protons and between π^- mesons in central C-Ne, Mg-Mg, C-Cu and O-Pb collisions has been carried out. The dependence of $C(\Delta\varphi)$ - correlation function between particle groups emitted in the forward and backward hemispheres has been studied for the first time. By fitting the experimental spectra the asymmetry coefficient ξ and the strength of correlation ζ has been determined. The type of correlations between protons (C-Ne, C-Cu) and between π^- mesons (C-Ne, Mg-Mg, C-Cu, O-Pb) and the dependence of the correlation parameters ξ and ζ on the A_T -target mass numbers have been investigated. The obtained results have been compared with the predictions of the QGSM.

Practical Value.

- The anisotropy coefficient a of π^- mesons produced in central Mg-Mg collisions at energy of 3.7 GeV/nucleon increases linearly with E_{kin}/E_{kin}^{max} starting from approximately 150 MeV. In the range up to 150 MeV the coefficient is small $a = 0.085 \pm 0.020$, therefore the π^- mesons are emitted almost isotropically.

- The shape of the energetic spectra of π^- mesons emitted at fixed angles in He(Li,C), C-Ne, Mg-Mg, C-Cu, and (C,O)Pb collisions in both laboratory ($10^\circ \leq \theta_{lab.} \leq 180^\circ$) and C.M. ($\theta_{C.M.S.} = 90^\circ \pm 10^\circ, 90^\circ \pm 20^\circ$) systems does not depend on A_P and A_T for all colliding pairs of nuclei. The values of the slope parameter E_o of the spectra decrease with increasing of θ_{lab} from 10° to 110° and remain practically constant at ~ 50 -60 MeV for angles larger than 110° .

- For π^- mesons produced in He(Li,C), C-Ne, Mg-Mg, C-Cu, and (C,O)Pb collisions the angular dependence of E_o is well described by the fireball model. The temperature E_o^\perp and the velocity β of the cluster emitting π^- mesons have been obtained from the model. The temperature weakly depends on A_P , A_T , while the velocity does not depend on A_P , A_T .

- The obtained collective flow effects and multiparticle azimuthal correlations in central C-Ne, Mg-Mg, C-Cu and O-Pb collisions at energy of 3.7 GeV/nucleon, show the persistence of these collective phenomena in the range of intermediate energy, i.e. from the Bevalac and GSI/SIS up to Dubna, AGS, RHIC and SPS energies.

- The statistical programs of experimental data processing and analyses have been elaborated for the personal computers in High Energy Physics Institute of Tbilisi State University, which can be used for the processing and analysis of the data of the other experiments.

Structure and Basic Contents of the Thesis. The thesis contains an introduction, five chapter, conclusions and referred bibliography. It consists of 112 pages, accounts 30 figures and 7 tables. The references include 147 items. The experimental data obtained at the Laboratory of High Energies JINR by the SKM-200-GIBS Collaboration have been used.

Introduction presents the subjects of the thesis, its aims and obtained results. Structure of the thesis and its short overview are given.

Chapter I is devoted to the description of the spectrometer GIBS, which has been constructed at the Laboratory of High Energies, at JINR/DUBNA, and is a modified version of the SKM-200 set-up. The Facility consists of a 2m streamer chamber with the volume of a $2 \times 1 \times 0.6 \text{ m}^3$, placed in a magnetic field of $\sim 0.8 \text{ T}$ ($\sim 0.9 \text{ T}$ for GIBS) and a triggering system. In the first Chapter the main elements of both spectrometers are described and the physical parameters of spectrometers have been compared. The streamer chamber was exposed to beams of ^4He , ^{12}C , ^{16}O , ^{20}Ne (SKM-200) and ^{12}C , ^{19}F , ^{24}Mg (GIBS) nuclei accelerated in the synchrophasotron up to at energy per incident nucleon of 3.7 GeV .

Solid targets Li, C, Cu and Pb in the form of thin discs with thickness of $(0.2 \div 0.5) \text{ g/cm}^2$ (the thickness of Li was 1.5 g/cm^2) were mounted within the fiducial volume of the SKM-200 chamber. Neon-gas filling of the chamber also served as a nuclear target. C, F and Mg solid targets with thickness 0.99 g/cm^2 , 1.34 g/cm^2 and 1.56 g/cm^2 , correspondingly, were used for GIBS set-up. Experimental set-up and the logic of the triggering system are presented in Fig. 1. The "inelastic" trigger, consisting of two sets of scintillation counters mounted upstream (S1 – S4) and downstream (S5, S6) the chamber, has selected all inelastic interactions of incident nuclei on a target. The "central" trigger was selecting events defined as those without charged projectile spectator fragments and spectator neutrons ($P/Z > 3 \text{ GeV}/c$), emitted within a cone of half angle $\theta_{ch} = 2.4^\circ$ or 2.9° and $\theta_n = 1.8^\circ$ or 2.8° for SKM-200, and $\theta_{ch} = \theta_n = 2.4^\circ$ for GIBS set-up.

The streamer chamber pictures were scanned twice at HEPI TSU and JINR/DUBNA. The final results of scanning and measurement of events have been recorded on the Data Summar Tapes (DST) and then have been analysed by using the standard statistical programs HBOOK and PAW.

Chapter II is devoted to the description of the intranuclear cascade model (CAScade Intranuclear Made in Rossendorf) CASIMIR and the Quark Gluon String Model (QGSM) which have been used for comparison with the experimental results presented in this thesis. In CASIMIR model the colliding nuclei are represented as an assembly of nucleon, the positions and momenta of which are randomly distributed according to realistic nuclear density and the law of a cold free Fermi gas, respectively. The nucleon momenta are distributed according to a sharp Fermi sphere with a radius of $P_F = 270 \text{ MeV}/c$. The cascade is subsequently traced in time by the Monte Carlo technique. The nucleons are assumed to move freely along straight lines between collisions. For any pair of particles the minimum distance of approach is

$$d_{min} \leq \sqrt{\sigma_{tot}(\sqrt{s})}/\pi, \quad (1)$$

where $\sigma_{tot}(\sqrt{s})$ is the total cross section for the pair as a function of CM energy. The inelastic scattering of nucleons, which is almost entirely dominated by single- and double-

pion production in the energy range of our interest, is assumed to proceed via the formation of two different resonances $\Delta(1232)$ and $N^*(1640)$.

In the string models the particles are produced via the quark-gluon strings formations and decays. The quark-gluon strings are excited objects consist of quark-antiquark or quark-diquark pairs connected via color field. The string masses are formed as a result of composite quarks longitudinal motion. The Monte Carlo generator COLLI is based on the Quark Gluon String Model. It is possible to study hadron-nuclear, hadron-nucleus and nucleus-nucleus collisions in a wide energy interval and especially in the range of intermediate energy ($\sqrt{s} \leq 4$ GeV) by this program. The procedure of event generation consists of three steps: 1) the definition of configurations of colliding nucleons, 2) production of quark-gluon strings and 3) fragmentation of strings (breakup) into observed hadrons. The coordinates of nucleons are generated according to a realistic nuclear density. It is assumed that the distance between them is greater than 0.8 fm. The maximum nucleon fermi momentum is

$$P_F = (3\pi^2)^{1/3} \cdot h \cdot \rho^{1/3}(r), \quad (2)$$

where $h=0.197$ fm·GeV/c, ρ is nuclear density. For main NN and π N interactions the following topological quark diagrams were used: binary, "undeveloped" cylindrical, diffractive and planar. Binary process makes a main contribution. This reaction predominantly results in the production of resonances (for instance, $NN \rightarrow N\Delta^{++}$), which are the main sources of pions. The QGSM simplifies the nuclear effects, in particular, coupling of nucleons inside the nucleus is neglected, and the decay of excited recoil nuclear fragments and coalescence of nucleons is not included.

Chapter III is devoted to the detailed study of pion production in central Mg-Mg collisions at energy of $E=3.7$ GeV/nucleon. The choice of π^- mesons is due to the fact, that they are dominantly produced particles, carry information about the dynamics of collisions and can be unambiguously identified. Also, the production of π^- mesons is the predominant process at the energies of the Dubna synchrophasotron. In this chapter the possible sources of experimental biases and appropriate correction procedures for π^- mesons are described. It has been shown that the dependence of the average kinematical characteristics, $\langle P_T \rangle$ and $\langle Y \rangle$, of π^- mesons on the multiplicity n_-/A_P differs from that for NN collisions at the same energy, which is due to nuclear effects. The correlation between $\langle P_T \rangle$ and Y (Fig. 2) has been studied. One can see that $\langle P_T \rangle$ is smaller in the fragmentation regions of the projectile and target. The maximum of $\langle P_T \rangle$ corresponds to $y_{NN}=1.14$. The shape of the P_T distributions in various intervals of Y are described. In the central region of Y the P_T spectra are less steep and extended up to 1.4 GeV/c, in the fragmentation regions the spectra are more sloping and extended up to (0.5 ÷ 0.8) GeV/c. The shape of P_T dependence is similar in the fragmentation regions of projectile and target.

The degree of anisotropy in pion emission can be more directly determined by studying the angular distributions in the c.m.s. of colliding nuclei. The approximation of this distributions by quadratic form gives for anisotropy coefficient: $a_{exper} = 0.62 \pm 0.02$ and $a_{model} =$

0.63 ± 0.02 (using the CASIMIR code). It has been shown, that the anisotropy coefficient increases linearly with E_{kin}/E_{kin}^{max} (E_{kin} is the kinetic energy, E_{kin}^{max} – the maximum available energy in the c.m.s. of π^- mesons) starting from approximately 150 MeV (Fig. 3). In the range up to 150 MeV the coefficient is small $a = 0.085 \pm 0.020$, therefore the π^- mesons are emitted almost isotropically, which may be caused by an increase of the number of NN collisions. The anisotropy coefficient increases linearly with E_{kin}/E_{kin}^{max} also for the generated data, but the slope is more steep than for the experimental data.

The energy spectra of π^- mesons at fixed angles in the laboratory and c.m. systems in He-Li, He-C, C-Ne, Mg-Mg, C-Cu, C-Pb and O-Pb collisions at energy of $E = 3.7$ GeV/nucleon have been investigated. The spectra of π^- mesons depend exponentially on their kinetic energy. The values of the slope parameter $E_o(\theta_{lab.})$ of the spectra - the result of exponential approximation of energy spectra are presented in Table 1. One can see that in the forward hemisphere ($\theta_{lab.} < 90^\circ$) two groups of nucleus pairs can be distinguished: approximately symmetric and lighter He(Li, C), C-Ne, Mg-Mg and asymmetric and heavier C-Cu, (C, O)Pb. In each group E_o parameters coincide within errors and, between these two groups, differ no more than 15%. Concerning π^- mesons from the backward hemisphere ($\theta_{lab.} > 90^\circ$), E_o parameters coincide within errors for all interactions and there is no dependence on A_P , A_T . The values of the parameter E_o in the c.m. system have the same tendency as in the laboratory system. The shape of the energy spectra at angular intervals $\theta_{c.m.s.} = 90^\circ \pm 10^\circ$ and $90^\circ \pm 20^\circ$ does not depend on A_P , A_T for all pairs of nuclei. The values of E_o decrease from (250-300 MeV to ~ 60 MeV with increasing $\theta_{lab.} > 10^\circ$ from 10° to 110° (Fig. 4). From the dependence of E_o parameter on $\theta_{lab.} > 10^\circ$ for each colliding pairs of nuclei, the temperature E_o^\perp of the cluster formed in the collision and emitting the particles, and its velocity β have been obtained by use of fireball model approximation $E_o = E_o^\perp / (1 - \beta \cos \theta_{lab.})$. The values of E_o^\perp are comparatively larger ~ 75 MeV for approximately symmetric and lighter groups of nuclear pairs He(Li, C), C-Ne, Mg-Mg, than for asymmetric and heavier pairs of nuclei C-Cu, (C, O)Pb ~ 69 MeV.

Chapter IV is devoted to the experimental results obtained from the in-plane transverse momentum analysis of π^- mesons in central C-Ne, Mg-Mg, C-Cu and O-Pb interactions at energy of $E = 3.7$ GeV/nucleon. As the π^- mesons are emitted mainly from decays of Δ -isobars (at least $\sim 80\%$), we decided to investigate whether a single π^- meson of the event knows something about its origin and the question whether they are collectively correlated. Many different methods were proposed for the study of flow effects in relativistic nuclear collisions, of which the most commonly used are - the transverse momentum analysis technique developed by P. Danielewicz and G. Odnycie and Fourier analysis of the azimuthal distributions on the event-by-event basis in relatively narrow rapidity windows proposed by M. Demoulin, S. Voloshin and Y. Zhang. We have used the technique of P. Danielewicz and G. Odnycie in our analysis. The method involves two basic ideas: 1) to select the rapidity range and rapidity dependent weighting factors to the real reaction plane, and 2) to remove trivial and

spurious self-correlations from the projections. Autocorrelations are removed by calculating \vec{Q} individually for each particle without including that particle into sum:

$$\vec{Q}_j = \sum_{i \neq j}^n \omega_i \vec{P}_{Ti} \quad (3)$$

where i is a particle index and ω_i is a weight, taken as 1 for $y_i > y_{cms}$ and -1 for $y_i < y_{cms}$ (y_{cms} is c.m.s. rapidity and y_i is the rapidity of particle i). The transverse momentum of each particle in the estimated reaction plane is calculated as:

$$P_{xj}' = \sum_{i \neq j}^n \omega_i \cdot (\vec{P}_{Tj} \cdot \vec{P}_{Ti}) / |\vec{Q}| \quad (4)$$

The \vec{Q} vector have been constructed from the \vec{P}_{Ti} of only π^- mesons event-by-event for the events with multiplicity $n_- > 7$ in Mg-Mg collisions. It is known, that the estimated reaction plane differs from the true one, due to the finite number of particles in each event. The component P_x in the true reaction plane is systematically larger then P_x' the component in the estimated plane, hence $\langle P_x \rangle = \langle P_x' \rangle / \langle \cos\varphi \rangle$, where φ is the angle between the estimated and true planes and the correction factor $K = 1 / \langle \cos\varphi \rangle$. According to the method of Danielewicz and Odnyc, for the definition of $\langle \cos\varphi \rangle$, we divided each event randomly into two equal sub-events, constructed vectors \vec{Q}_I and \vec{Q}_{II} and estimated azimuthal angle $\phi_{1,2}$ between these two vectors $\langle \cos\varphi \rangle = \langle \cos\phi_{1,2} \rangle$. The correction factor, averaged over all the multiplicities, $K = 1.51 \pm 0.05$ has been obtained. Figure 5 shows the dependence of the estimated $\langle P_x'(Y) \rangle$ on Y for pions produced in the central Mg-Mg collisions. The data exhibit S-shape behavior similar to the form of the $\langle P_x \rangle$ spectra for protons and pions obtained at lower energies and identified as nucleon and pion collective flow. The slope at midrapidity has been extracted from a linear fit of the data for Y between $0.2 \div 2$, the value of $F = 48 \pm 5$ MeV/c have been obtained. In the model calculations the reaction plane is known a priori and is referred as the reaction plane. For simulated events (QGSM) the component in the true reaction plane P_x has been calculated and the dependence of $\langle P_x'(Y) \rangle$ on Y has been obtained for both not fixed \tilde{b} (6225 events) and fixed $\langle b \rangle = 1.34$ fm (6212 events) impact parameters (Fig. 5). The experimental and QGSM results coincide within errors. The values of F , obtained from the QGSM are: $F = 53 \pm 3$ (MeV/c) - for not fixed \tilde{b} , and $F = 51 \pm 4$ MeV/c - for 1.34 fm.

The similar in-plane analysis has been performed on π^- mesons too in central C-Ne, C-Cu and O-Pb collisions at the same energy. In this case the reaction plane has been obtained by only π^- mesons. The observed dependences show the typical S-shape behavior reflecting the presence of flow effects. The values of flow F increases with the mass number of target A_T from 33 ± 4 (MeV/c) to 50 ± 6 (MeV/c) (see Table 2). The obtained experimental results in central C-Ne, C-Cu and O-Pb collisions have been compared with the predictions of the QGSM. For this purpose C-Ne (6272), C-Cu (9327) and O-Pb (2431) collisions have been generated for impact parameters $b=2.20, 2.75$ and 3.74 (fm), respectively. The Quark Gluon

String Model reproduces the $\langle P_x \rangle$ distributions and satisfactorily describes the obtained experimental results for all pairs of nuclei.

It seems, that the obtained results indicate that the flow behavior of π^- mesons is due both to the flow of Δ resonances and of the nuclear shadowing effect. Our experimental results, obtained using the streamer chamber technique, provide quantitative information on the directed flow of π^- mesons and their dependence on target-mass, complementing the experimental data available from the BEVALAC, GSI-SIS, AGS and CERN/SPS.

Chapter V is devoted to the multiparticle azimuthal correlations between protons and between pions in central C-Ne, Mg-Mg, C-Cu and O-Pb collisions at energy of 3.7 GeV/nucleon. Identification of secondary particles becomes very important for the study of products of nucleus-nucleus ($A_P - A_T$) collisions via collective variables, which are defined event by event. The admixture of π^- mesons amongst the charged positive particles is about (25 \div 27). The statistical method has been used for the identification of π^+ mesons. The main assumption is based on the similarity of spectra of π^- and π^+ mesons (n_-, P_T, P_L). The two-dimensional distribution of P_T, P_L variables have been used for identification of π^- mesons. After performed identification the admixture of π^- mesons amongst the protons is not exceeding (5 \div 7)%. The azimuthal correlation function $C(\Delta\varphi)$ was defined by the relative angle between the transverse momentum vectors sums of particles emitted in forward and backward hemispheres:

$$\vec{Q}_F = \sum_{y_i \geq \langle y \rangle} \vec{P}_{Ti} \quad (5)$$

and

$$\vec{Q}_B = \sum_{y_i < \langle y \rangle} \vec{P}_{Ti} \quad (6)$$

where $\langle y \rangle$ is the average rapidity in each event. The correlation function $C(\Delta\varphi)$ is constructed as follows:

$$C(\Delta\varphi) = dN/d\Delta\varphi \quad (7)$$

where $\Delta\varphi$ is the angle between these vectors:

$$\Delta\varphi = \arccos(\vec{Q}_B \cdot \vec{Q}_F) / |\vec{Q}_B| \cdot |\vec{Q}_F|. \quad (8)$$

For protons a "back-to-back" negative correlations were observed in C-Ne and C-Cu collisions i.e., protons are preferentially emitted at $\Delta\varphi = 180^\circ$. To quantify these experimental results, the data were fitted by $C(\Delta\varphi) = 1 + \xi \cos(\Delta\varphi)$, where ξ is the asymmetry coefficient. The strength of correlation ζ was defined as

$$\zeta = C(0^\circ)/C(180^\circ) = (1 + \xi)/(1 - \xi). \quad (9)$$

In Table 3 the asymmetry coefficient $\xi < 0$ and the strength of correlation $\zeta < 1$ for protons in both C-Ne and C-Cu interactions are presented. One can see that $|\xi|$ increases and ζ decreases with increase of target mass. A back-to-back pion correlations have been obtained for a light, symmetric pairs of nuclei C-Ne and Mg-Mg ($n_- \geq 7$), where ξ and ζ parameters have the same behavior as for protons (Fig. 6a). For heavy pairs of nuclei C-Ne and O-Pb, side-by-side (positive) pion correlations were observed i.e. in this case they are preferentially emitted at $\Delta\varphi = 0^\circ$ (Fig. 6b). The asymmetry coefficient ξ and the strength of correlations ζ increase with increase of A_P and A_T . The variation of pion correlations (from negative for light systems of C-Ne, Mg-Mg to positive for heavy systems of nuclei C-Cu, O-Pb), which have been observed in our experiment, indicate, that at Dubna energies the flow behavior of π^- mesons in a light system is due the flow of Δ resonances ($\pi N \rightarrow \Delta$ and $\Delta N \rightarrow NN$), whereas the antifold behavior in a heavier system is the result of the nuclear shadowing effect.

To be convinced that the azimuthal correlations between protons and between pions are due to correlations between these particles and can not be the result of detector biases or finite-multiplicity effects, we obtained the of $C(\Delta\psi)$ on ψ for secondaries, where ψ is the angle between the transverse momentum of each particle emitted in the backward (forward) hemisphere and $\vec{Q}_F(\vec{Q}_B)$ vector, respectively. No correlations have been obtained for C-Cu interactions both for protons and for pions. Similar results have been obtained for C-Ne collisions.

In order to extend these investigations, the relation between $\langle P_x^2 \rangle$ and the angle $\Delta\varphi$, where $\Delta\varphi$ is the opening angle between \vec{Q}_F and \vec{Q}_B vectors has been obtained. One can see from Fig. 7, that for protons in C-Ne and C-Cu collisions the distributions show S-shape behavior and slopes of distributions increase with target mass; We stress, that at $\Delta\varphi = 90^\circ$ the values of $\langle P_x \rangle$ do not depend on A_T .

The Quark Gluon String Model (QGSM) satisfactorily describes the obtained results for protons and for π_- mesons for all pairs of nuclei.

The comparison of our experimental results with the data of various collaborations (BEVALAC, JINR, CERN/SPS) has been carried out and had been showed that these multi-particle azimuthal correlations between the same types of secondaries exist for the energy interval of (0.1 ÷ 200) GeV/nucleon.

Conclusions list main results of the conducted research work, which are outlined bellows.

The Main Results of the Thesis

1. A detailed study of pion production in central Mg-Mg collisions at energy of $E=3.7$ GeV per nucleon ($P = 4.3$ GeV/c/nucleon) have been carried by the Lorentz invariant variables: the rapidity Y and the transverse momentum P_T . The average values of $\langle Y \rangle$ and $\langle P_T \rangle$ decrease with increasing of multiplicity, n_-/A_P , different to NN collisions, where the values of both average kinematical characteristics remain constant with increase of n_-/A_P . n_-/A_P is the measure of the impact parameter b .

The correlation between $\langle P_T \rangle$ and Y has been studied: $\langle P_T \rangle$ is smaller in the fragmentation regions of the projectile and target (the maximum of $\langle P_T \rangle$ corresponds to $y_{NN} = 1.14$). In the central region of Y the P_T distributions are less steep and extended up to 1.4 GeV/c.

2. In the analysis of angular distributions of π^- mesons in Mg-Mg collision the anisotropy coefficient $a_{exper.} = 0.62 \pm 0.02$ has been obtained; The obtained results qualitatively agree with the predictions of the intranuclear cascade model CASIMIR $a_{model} = 0.63 \pm 0.02$. The anisotropy coefficient increases linearly with E_{kin}/E_{kin}^{max} (E_{kin} is the kinetic energy, E_{kin}^{max} – the maximum available energy in the c.m.s. of π^- mesons) starting from approximately 150 MeV. In the range up to 150 MeV the coefficient is small $a = 0.085 \pm 0.020$, therefore the π^- mesons are emitted almost isotropically. The anisotropy coefficient increases linearly with E_{kin}/E_{kin}^{max} also for the generated data (CASIMIR), but the slope is more steep than for the experimental data.

3. The energy spectra of π^- mesons emitted at fixed angles in the laboratory ($10^\circ \leq \theta_{lab} \leq 90^\circ$) and c.m. systems ($\theta_{c.m.s.} = 90^\circ \pm 10^\circ$ and $90^\circ \pm 20^\circ$) in He-Li, He-C, C-Ne, Mg-Mg, C-Cu, C-Pb and O-Pb collisions collisions at energy of $E=3.7$ GeV/nucleon depend exponentially on their kinetic energy. The shape of spectra in both systems does not depend on A_P , A_T for all colliding pairs of nuclei. The values of the slope parameter E_o of the spectra depend on A_P , A_T for angles $\theta_{lab} < 90^\circ$ and are independent for $\theta_{lab} > 90^\circ$. The values of E_o decrease from ~ 250 - 300 MeV to ~ 60 MeV with increasing θ_{lab} from 10° to 110° , and remain practically constant at ~ 50 - 60 MeV for angles larger 110° . The angular dependence of E_o parameter has been approximated by the fireball model. From the approximation the parameters of the model - the temperature E_o^\perp and velocity β of the cluster emitting π^- mesons have been extracted. The temperature weakly depends on A_P , A_T while the velocity does not depend on A_P , A_T .

4. The investigation of in-plane flow effects for π^- mesons in central Mg-Mg collisions by the transverse momentum technique of P. Danielewicz and G. Odyniec has been carried out. For the first time, the reaction plane have been determined only by π^- mesons in each event. The similar analysis of in-plane flow effects for π^- mesons production in central C-Ne, C-Cu and O-Pb collisions at the same energy has been performed. The observed dependence of $\langle P_x'(Y) \rangle$ on Y shows S-shape behavior. The values of F flow parameter, defined as the slope at midrapidity, have been extracted for all colliding pairs of nuclei. F increases with the mass numbers of target A_T from 33 ± 4 (MeV/c) to 50 ± 6 (MeV/c). The Quark Gluon String Model (QGSM) reproduces the $\langle P_x \rangle$ distributions and satisfactorily describes obtained experimental results for all pairs of nuclei.

5. The multiparticle azimuthal correlations between protons and between pions in central C-Ne, Mg-Mg, C-Cu and O-Pb collisions have been studied. The dependence of the azimuthal correlation function $C(\Delta\varphi)$ on the $\Delta\varphi$, where $\Delta\varphi$, is angle between the transverse momentum vectors sums of particles emitted in forward and backward hemispheres, in these collisions

have been investigated:

For protons a "back-to-back" (negative) correlations were observed in central C-Ne and C-Cu interactions. The asymmetry coefficient $|\xi$ ($\xi < 0$) increases and the strength of correlation ζ ($\zeta < 1$) decreases with increase of the target mass A_T .

"Back-to-back" pion correlations have been obtained for a light pairs of nuclei (C-Ne and Mg-Mg), where ξ and ζ parameters have the same behavior as for protons. For heavy pairs of nuclei (O-Pb and C-Cu) "side-by-side" (positive) pions correlations were observed. The asymmetry ($\xi > 0$) and strength of correlation ($\zeta > 1$) increase with increase of A_P and A_T .

The QGSM satisfactorily describes multiparticle azimuthal correlations of protons and π^- mesons for all pairs of nuclei.

Approbation of the Work. The basic results of the investigations were reported at: Seminars in High Energy Physics Institute of Tbilisi State University and in Dubna Joint Institute of Nuclear Research, International Symposium in Elementary Particle Physics dedicated to the memory G. Chikovani, 21-23 September, 1998, Tbilisi; On the 1999 European School of young scientist in High-Energy Physics, Casta-Papiernicka, Slovak Republic, 22 August - 4 September and on the Seventh International Conference in Nucleus-Nucleus Collisions 2000, July 3-7, Strasbourg, France.

Publications

1. Chkhaidze L., Djobava T. and Kharkhelaury L., "The investigation of energy spectra of π^- mesons at fixed angles in nucleus-nucleus interactions at a momentum of 4.5 GeV/c per incident nucleon." – J. Phys., 1993, v.19G, p.1155-1161.

2. Chkhaidze L., Djobava T., Gogiberidze G., Kharkhelaury L. and Mosidze M., "Study of the inclusive reaction $\text{Mg-Mg} \rightarrow \pi^- + X$ at a momentum of 4.3 GeV/c per incident nucleon." – J. Phys., 1996, v.22G, p.641-651.

3. Chkhaidze L., Djobava T., Kharkhelaury L. and Mosidze M. "The comparison of characteristics of π^- mesons produced in central Mg-Mg interactions with the quark gluon string model predictions." – Eur. Phys. J., 1998, v.1A, p.299-306; hep-ex/980528;

4. Chkhaidze L., Djobava T and Kharkhelaury L., "Multiparticle azimuthal correlations in central nucleus-nucleus collisions at energy of 3.7 GeV per nucleon." – Bulletin of the Georgian Academy of Sciences "Moambe", 2001, v.164, N1, p.51-55.

5. Chkhaidze L., Djobava T. and Kharkhelaury L., "Study of multiparticle azimuthal correlations in central CNe, MgMg, CCu and OPb interactions at energy of 3.7 GeV per nucleon." – Phys. Atom. Nucl. 65:1479-1486, 2002; Yad. Fiz. 65: 1515-1522; nucl-ex/0107017.

Table 1. The values of the parameter E_o – the result of approximating π_- mesons energy spectra by formula $\sigma_{inv.} = A \exp(E_{kin}/E_o)$.

θ_{lab} intervals (grad)	ΔE_{kin} (GeV)	E_o (GeV)				
		He(Li,C)	C-Ne	Mg-Mg	C-Cu	(C,O)Pb
10-20	0.2-0.3	0.408 ± 0.009	0.390 ± 0.010	0.378 ± 0.006	0.349 ± 0.008	0.318 ± 0.008
20-30	0.15-2.1	0.289 ± 0.007	0.283 ± 0.009	0.271 ± 0.005	0.259 ± 0.006	0.234 ± 0.007
30-40	0.10-1.6	0.211 ± 0.006	0.200 ± 0.007	0.210 ± 0.005	0.182 ± 0.004	0.175 ± 0.005
40-50	0.05-1.2	0.161 ± 0.005	0.159 ± 0.006	0.170 ± 0.004	0.140 ± 0.004	0.136 ± 0.004
50-70	0.05-1.0	0.123 ± 0.004	0.121 ± 0.006	0.122 ± 0.003	0.109 ± 0.003	0.098 ± 0.003
70-90	0.05-0.7	0.083 ± 0.005	0.080 ± 0.005	0.089 ± 0.004	0.079 ± 0.003	0.071 ± 0.003
90-110	0.05-0.7	0.059 ± 0.005	0.057 ± 0.005	0.059 ± 0.002	0.059 ± 0.002	0.058 ± 0.002
110-130	0.05-0.5	0.064 ± 0.011	0.060 ± 0.008	0.053 ± 0.005	0.052 ± 0.003	0.055 ± 0.003
130-180	0.05-0.5	0.046 ± 0.004	0.052 ± 0.007	0.052 ± 0.004	0.046 ± 0.003	0.041 ± 0.003

Table 2. The number of experimental events N_{event} , the average multiplicity of protons (participant) $\langle n_{prot} \rangle$ and π^- mesons $\langle n_{\pi^-} \rangle$, and the flow parameter in central C-Ne, Mg-Mg, C-Cu and O-Pb collisions (the reaction plane has been obtained by π^- mesons only).

$A_P - A_T$	C-Ne	Mg-Mg	C-Cu	O-Pb
N_{event}	723	6239	1866	732
$\langle n_{prot} \rangle$	12.4 ± 0.5	–	19.5 ± 0.6	–
$\langle n_{\pi^-} \rangle$	7.8 ± 0.4	8.2 ± 0.4	6.6 ± 0.3	9.8 ± 0.5
F (MeV/c)	33 ± 4	48 ± 5	41 ± 5	50 ± 6

Table 3. The number of experimental events N_{event} and of participant protons $N_{prot.}$, the asymmetry coefficient (ξ), the strength of the correlation (ζ) and the average rapidity ($\langle y \rangle$) of protons in central C-Ne and C-Cu collisions.

$A_P - A_T$	N_{event}	$N_{prot.}$	ξ	ζ	$\langle y \rangle$
C-Ne	723	9201	-0.23 ± 0.05	0.63 ± 0.09	1.07 ± 0.07
C-Cu	663	12715	-0.35 ± 0.05	0.48 ± 0.06	0.73 ± 0.05

GIBS

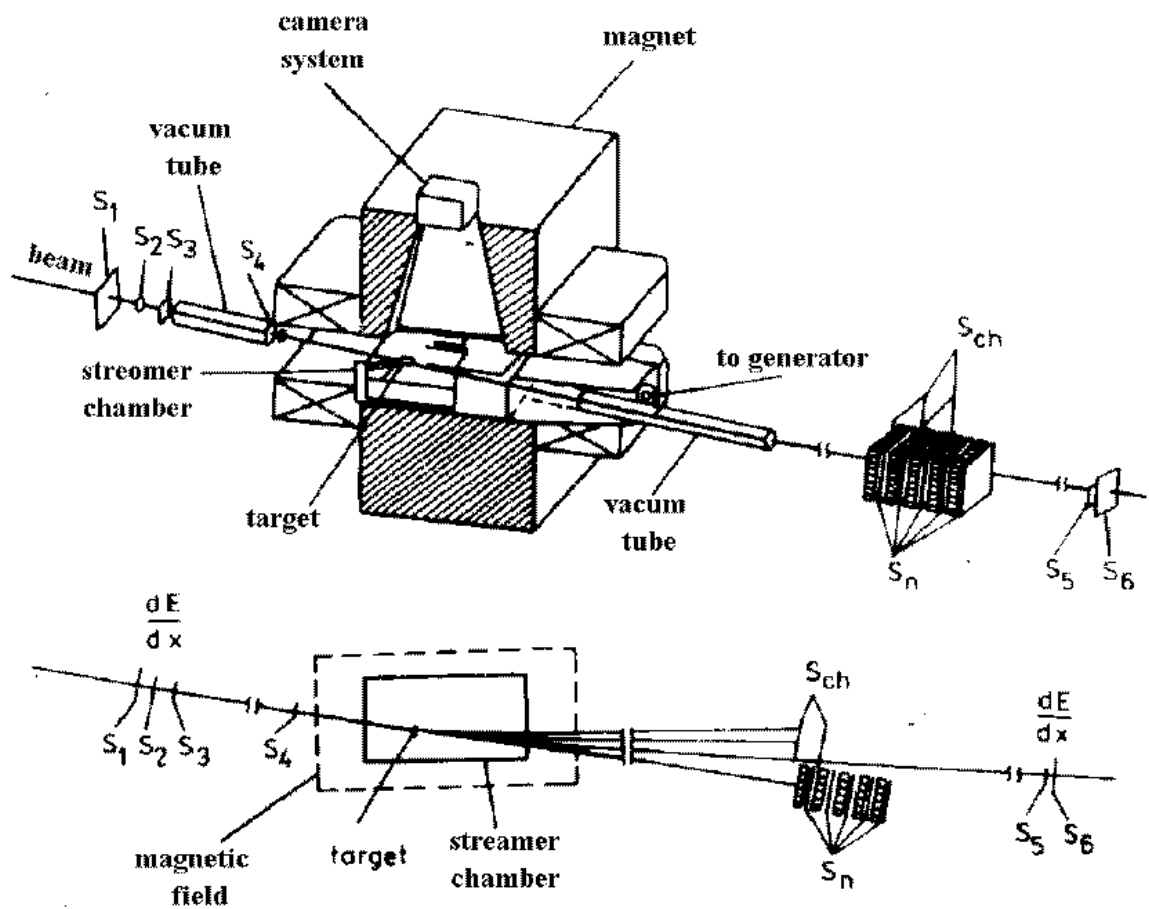

"INELASTIC" TRIGGER = $S_1 \wedge S_2 \wedge S_3 \wedge S_4 \wedge \bar{S}_5 \wedge \bar{S}_6$

"CENTRAL" TRIGGER = $S_1 \wedge S_2 \wedge S_3 \wedge S_4 \wedge \bar{S}_n \wedge \bar{S}_{ch}$

Figure 1: Experimental set-up. The trigger and trigger distances are not to scale.

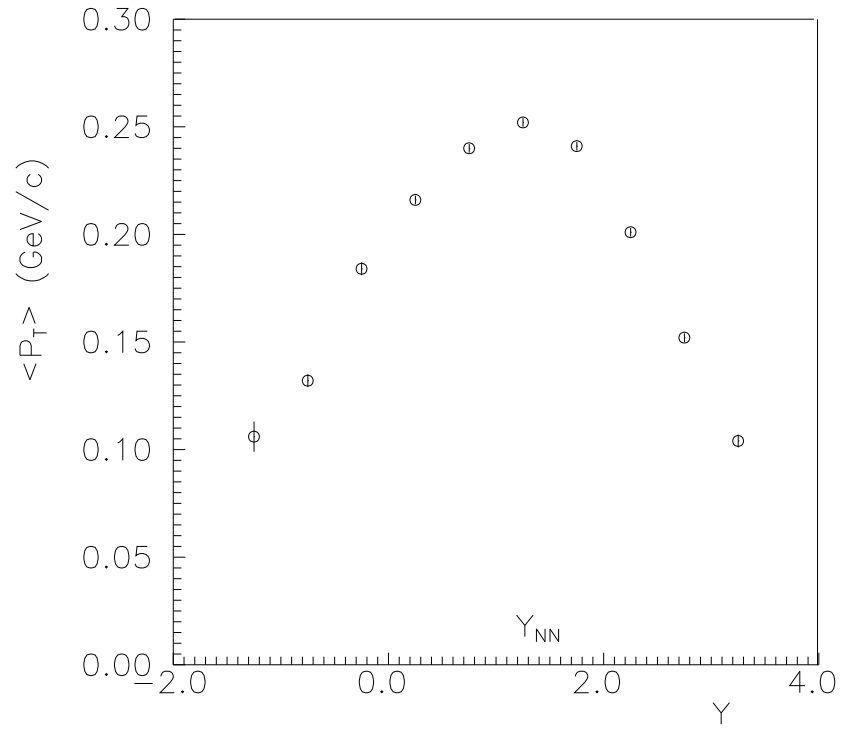

Figure 2: The dependence of the average transverse momentum $\langle P_T \rangle$ on the rapidity Y for π^- mesons.

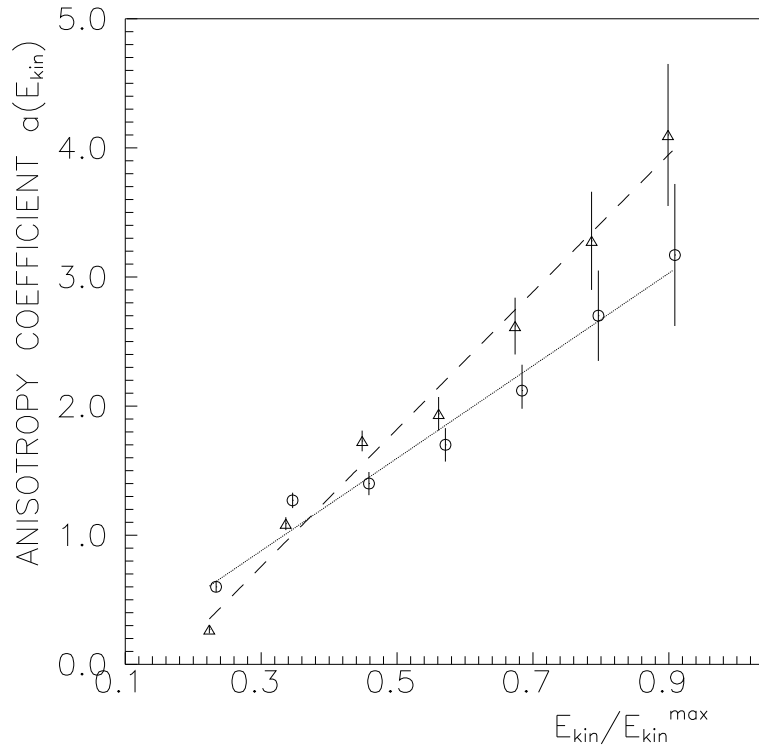

Figure 3: The dependence of the anisotropy coefficient a on the E_{kin}/E_{kin}^{max} (E_{kin} is the kinetic energy, E_{kin}^{max} – maximum available energy in the c.m.s. of π^- mesons): \circ – experiment, \triangle – CASIMIR. The lines are the result of a linear approximation of the experimental and generated data, respectively.

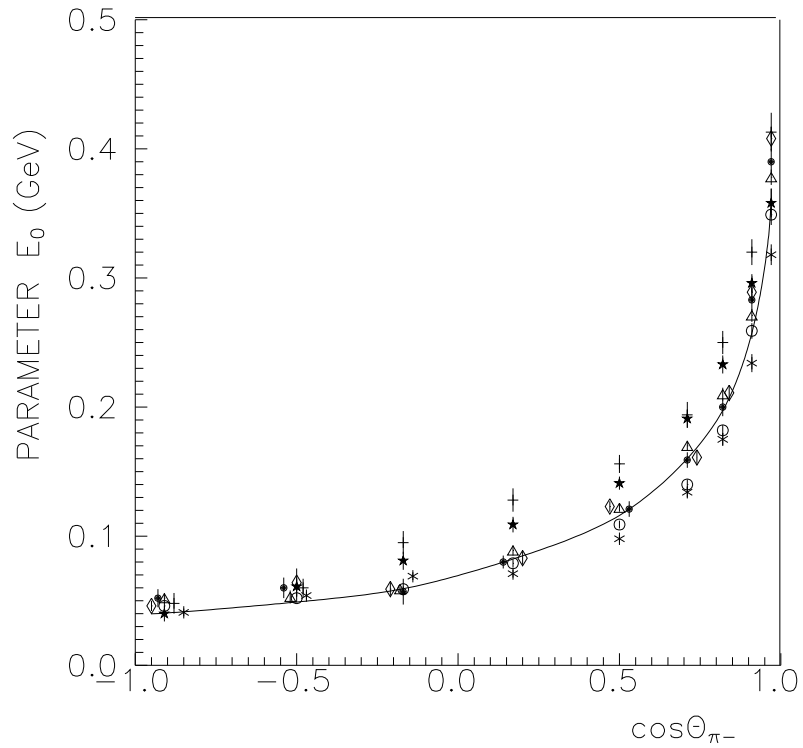

Figure 4: The angular dependence of the parameter E_o for Δ - He(Li, C), * - C-Ne, \bullet - Mg-Mg, \circ - C-Cu, \diamond - (C,O)Pb collisions (P=4.5 GeV/c/nucl) and \star - He-C, + - C-C collisions (P=4.2 GeV/c/nucl). The solid curve is the result of approximating the averaged values $E(\theta_{lab})$ by function $E_o = E_o^\perp / (1 - \beta \cos \theta_{lab})$

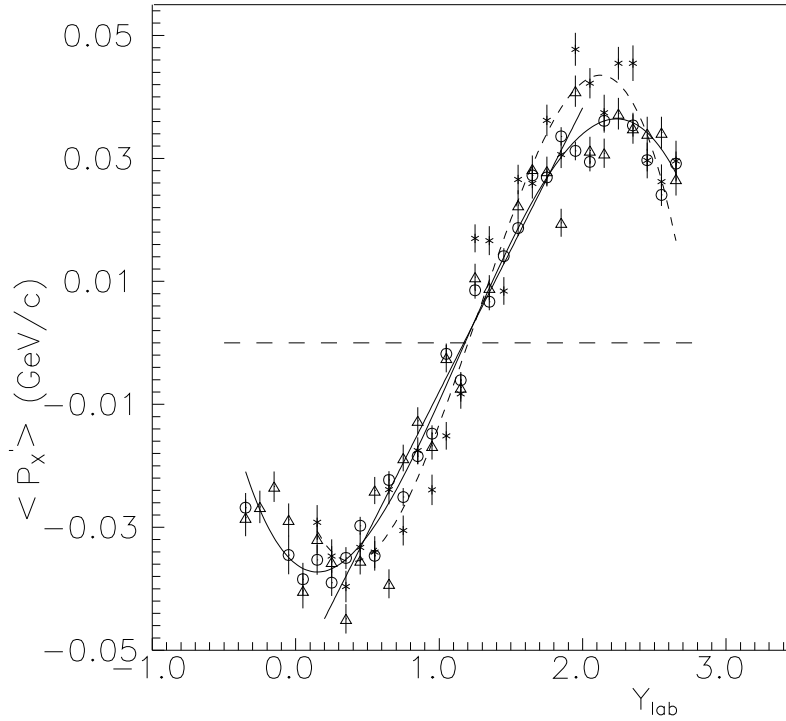

Figure 5: The dependence of $\langle P_x'(Y) \rangle$ on Y_{lab} for π^- mesons produced in the central Mg-Mg collisions: \circ – the experimental data and QGSM generated data for both \triangle – fixed $b= 1.34$ fm and $*$ – not fixed \tilde{b} impact parameters. The solid line is the result of the linear approximation of experimental data in the interval of $Y - 0.2 \div 2.0$. The curves for visual presentation of the QGSM events (solid - for fixed b , dashed -for \tilde{b}) – result of approximation by 4-th order polynomial.

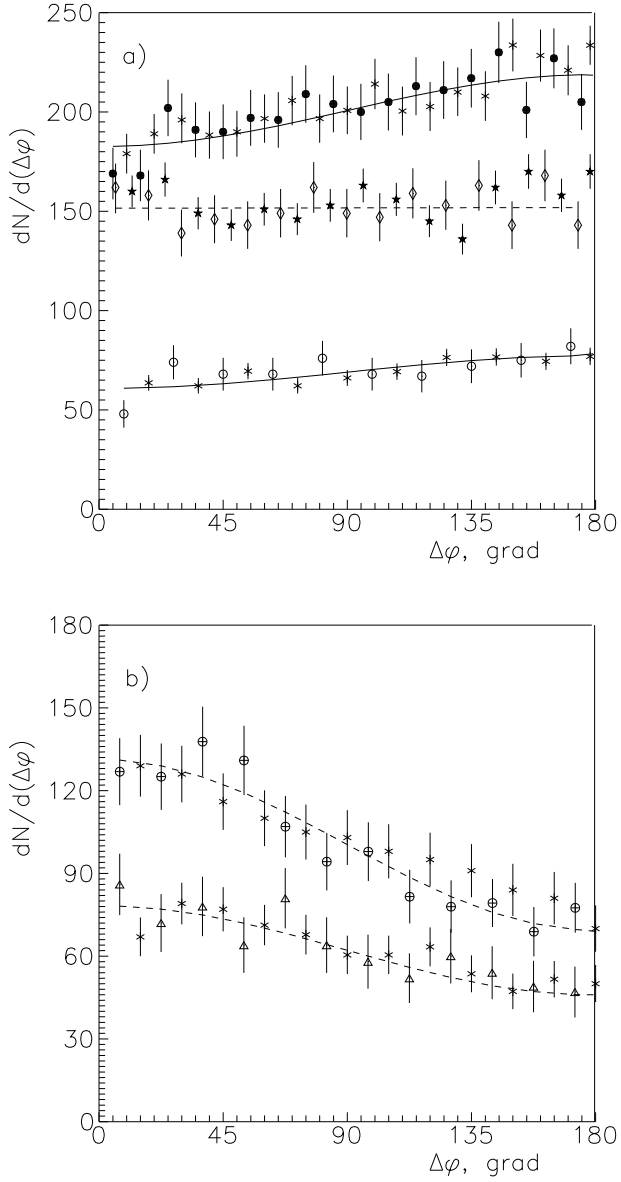

Figure 6: The correlation function $C(\Delta\varphi)$ as described in the text for π^- -mesons from: (a) \circ – C-Ne, \bullet – Mg-Mg ($n_- \geq 7$), \diamond – Mg-Mg ($n_- < 7$) and (b) \triangle – C-Cu, \oplus – O-Pb collisions. \times , \star – the QGSM generated data, respectively. The solid and dashed curves – results of the approximation of the data by function $C(\Delta\varphi)=1 + \xi\cos(\Delta\varphi)$.

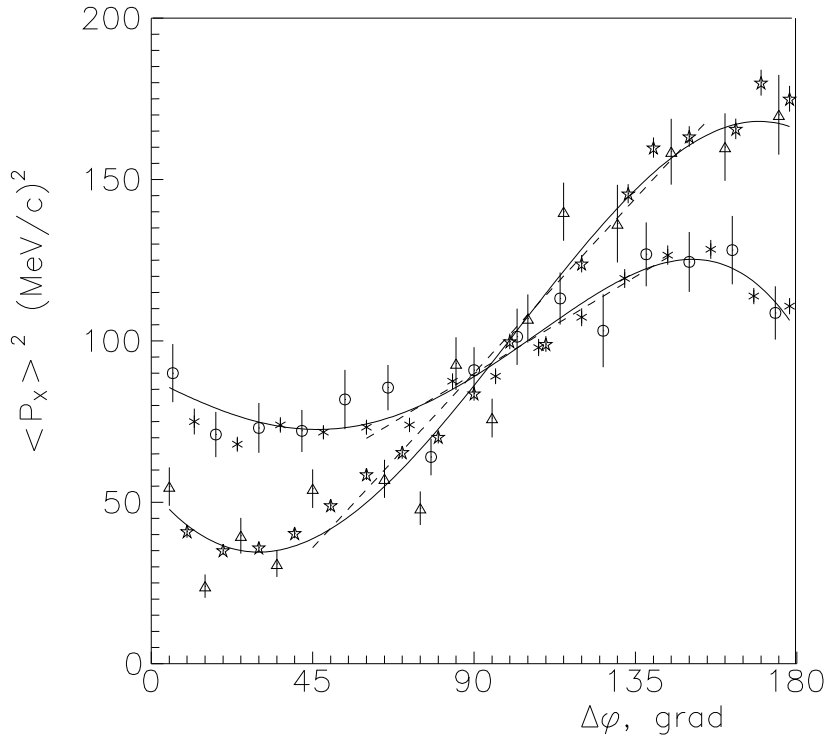

Figure 7: The dependence of $\langle P_x \rangle^2$ on the $\Delta\varphi$ for protons from: \circ – C-Ne and \triangle – C-Cu collisions and \times , \star – the QGSM data, respectively. The dashed lines are the result of the linear approximation of experimental data in the interval of $\Delta\varphi$ $60 \div 145$ and $45 \div 155$, respectively. The solid curves for visual presentation – result of approximation by 4-th order polynomial.