

Review of analytical treatments of barrier-type problems in plasma theory

F. Spineanu^{1,2}, M. Vlad^{1,2}, K. Itoh¹, S.-I. Itoh³

¹ National Institute for Fusion Science

322-6 Oroshi-cho, Toki-shi, Gifu-ken 509-5292, Japan

² Association EURATOM-MECT Romania

NILPRP, P.O.Box MG-36 Magurele, Bucharest, Romania

³ Research Institute for Applied Mechanics, Kyushu University,
Kasuga 816-8580, Japan

November 20, 2018

Abstract

We review the analytical methods of solving the stochastic equations for barrier-type dynamical behavior in plasma systems. The path-integral approach is examined as a particularly efficient method of determination of the statistical properties.

Contents

1	Introduction	2
2	The functional approach	3
2.1	Overview of the functional methods	3
2.2	The path integral with the MSR action	3
2.3	The Onsager-Machlup functional	7
2.4	Connection between the MSR formalism and Onsager-Machlup	9
3	The transition solutions (instantons)	11
3.1	Numerical trajectories	11
3.2	Elliptic functions instantons (from Onsager-Machlup action) .	12
3.3	Typical instanton solutions	15
3.4	Approximations of the instanton form	15

4	Fluctuations around the saddle point (instanton) solution	16
4.1	The expansion of the action functional around the extrema . . .	16
4.2	The harmonic region (diffusion around the equilibrium points)	20
4.2.1	Contribution from the trivial fixed point solutions . . .	20
4.2.2	Contribution from the trivial fixed point solution in the dual function approach	23
4.3	Assembling the instanton-anti-instanton solutions	27
4.3.1	The formulation based on Onsager-Machlup action . . .	27
4.3.2	The formulation using dual functions	33
4.4	The trajectory reflection and the integration along the contour in the complex time plane	
4.5	Summation of terms from multiple transitions	42
5	The probability	46
5.0.1	Transition and self-transition probabilities at the equilibrium points	46
5.0.2	Transitions between arbitrary points	47
6	Results	49

1 Introduction

A large number of physical systems, in particular in plasma physics, are described in terms of a variable evolving in a deterministic velocity field under the effect of a random perturbation. This is described by a stochastic differential equation of the form

$$\dot{x} = V(x) + \sqrt{2D}\xi(t) \tag{1}$$

where $V(x)$ is the velocity field and the perturbation is the white noise

$$\langle \xi(t) \xi(t') \rangle = \delta(t - t') \tag{2}$$

This general form has been invoked in several applications. More recently, in a series of works devoted to the explanation of the intermittent behavior of the statistical characteristics of the turbulence in magnetically confined plasma it has been developed a formalism based on barrier crossing. Previous works that have discussed subcritical excitation of plasma instabilities are Refs. [1], [2], [3], [4], [5], [6], [7], [8], [9].

We offer a comparative presentation of two functional integral approaches to the determination of the statistical properties of the system's variable $x(t)$ for the case where the space dependence of $V(x)$ is characterized by the presence of three equilibrium points, $V(x) = 0$. We will take

$$V(x) = ax - bx^3, \text{ with } a, b > 0 \tag{3}$$

2 The functional approach

2.1 Overview of the functional methods

In studying the stochastic processes the functional methods can be very useful and obtain systematic results otherwise less accessible to alternative methods. The method has been developed initially in quantum theory and it is now a basic instrument in condensed matter, field theory, statistical physics, etc. In general it is based on the formulation of the problem in terms of an action functional. There are two distinct advantages from this formulation: (1) the system's behavior appears to be determined by all classes of trajectories that extremize the action and their contributions are summed after appropriate weights are applied; (2) the method naturally includes the contributions from states close to the extrema, so that fluctuations can be accounted for.

There are technical limitations to the applicability of this method. In the statistical problems (including barrier-type problems) it is simpler to treat cases with white noise, while colored noise can be treated perturbatively. In the latter case, the procedure is however useful since the diagrammatic series can be formulated systematically.

The colored noise can be treated by extending the space of variables: the stochastic variable with finite correlation is generated by integration of a new, white noise variable.

The one dimensional version can be developed up to final explicit result. Since however the barrier type problem is frequently formulated in two-dimensions, one has to look for extrema of the action and enumerate all possible trajectories. It is however known that, in these cases, the behavior of the system is dominated by a particular path, “the optimum escape path”, and a reasonable approximation is to reduce the problem to a one-dimensional one along this system's trajectory.

2.2 The path integral with the MSR action

We will briefly mention the steps of constructiong the MSR action functional, in the Jensen path integral reformulation. We begin by choosing a particular realisation of the noise $\xi(t)$. All the functions and derivatives can be discretised on a lattice of points in the time interval $[-T, T]$ (actually one can take the limits to be $\pm\infty$). The solution of the equation (1) is a “configuration” of the field $x(t)$ which can be seen as a point in a space of functions. We extend the space of configurations $x(t)$ to this space of functions, including all possible forms of $x(t)$, not necessarily solutions. In this space the solution

itself will be individualised by a functional Dirac δ function.

$$\delta \left(\dot{x} - V(x) - \sqrt{2D}\xi(t) \right)$$

Any functional of the system's real configuration (*i.e.* solutions of the equations) can be formally expressed by taking as argument an arbitrary functional variable, multiplying by this δ functional and integrating over the space of all functions.

We will skip the discretization and the Fourier representation of the δ functions, followed by reverting to the continuous functions. The result is the following functional

$$Z_\xi = \int D[x(t)] D[k(t)] \exp \left[i \int_{-T}^T dt \left(-k\dot{x} + kV(x) + \sqrt{2D}k\xi \right) \right]$$

The label ξ means that the functional is still defined by a choice of a particular realization of the noise. The generating functional is obtained by averaging over ξ .

$$Z = \langle Z_\xi \rangle = \int D[x(t)] D[k(t)] \exp \left[i \int dt \left(-k\dot{x} + kV(x) + iDk^2 \right) \right] \quad (4)$$

We add a formal interaction with two currents

$$Z_J = \int D[x(t)] D[k(t)] \exp \left[i \int dt \left(-k\dot{x} + kV(x) + iDk^2 + J_1x + J_2k \right) \right] \quad (5)$$

in view of future use to the determination of correlations. This functional integral must be determined explicitly. The standard way to proceed to the calculation of Z_J is to find the saddle point in the function space and then expand the action around this point to include the fluctuating trajectories. This requires first to solve the Euler-Lagrange equations

$$\begin{cases} \dot{k} = -ak + 3bkx^2 - J_1 \\ \dot{x} = ax - bx^3 + 2iDk + J_2 \end{cases} \quad (6)$$

The simplest case should be examined first. We assume there is no deterministic velocity ($a = b = 0$) in order to see how the purely diffusive behavior is obtained in this framework

$$\begin{aligned} \dot{x} - 2iDk &= J_2 \\ \dot{k} &= -J_1 \end{aligned}$$

The equations can be trivially integrated [39], [40]

$$\begin{aligned} x^{(0)}(t) &= \int_{-T}^T dt \Delta_{11}(t, t') J_1(t') + \int_{-T}^T dt \Delta_{12}(t, t') J_2(t') \\ k^{(0)}(t) &= \int_{-T}^T dt \Delta_{21}(t, t') J_1(t') + \int_{-T}^T dt \Delta_{22}(t, t') J_2(t') \end{aligned}$$

where

$$\begin{aligned} \Delta_{11}(t, t') &= 2iD [t\Theta(t' - t) + t'\Theta(t - t')] \\ \Delta_{12}(t, t') &= \Theta(t - t') \\ \Delta_{21}(t, t') &= \Theta(t' - t) \\ \Delta_{22}(t, t') &= 0 \end{aligned}$$

with the symmetry

$$\Delta_{ij}(t, t') = \Delta_{ji}(t', t)$$

The lowest approximation to the functional integral Z_J is obtained from this saddle point solution, by calculating the action along this system's trajectory. We insert this solutions in the expression of the generating functional, for $V(x) \equiv 0$

$$\begin{aligned} Z_J^{(0)} &= \int D[x(t)] D[k(t)] \exp \left[i \int_{-T}^T dt \left(-k\dot{x} + iDk^2 + J_1x + J_2k \right) \right] \Big|_{x^{(0)}, k^{(0)}} \\ &= \exp \left[\frac{1}{2} i \int_{-T}^T dt \int_{-T}^T dt' J_i(t) \Delta_{ij}(t, t') J_j(t) \right] \end{aligned}$$

The dispersion of the stochastic variable $x(t)$ can be obtained by a double functional derivative followed by taking $J_i \equiv 0$. We obtain

$$\begin{aligned} \langle x(t) x(t') \rangle &= \frac{1}{Z_J^{(0)}} \frac{\delta^2}{\delta J_1(t) \delta J_1(t')} \exp \left[\frac{1}{2} i \int_{-T}^T dt \int_{-T}^T dt' J_i(t) \Delta_{ij}(t, t') J_j(t) \right] \Big|_{J_{1,2}=0} \\ &= D \min(t, t') \end{aligned}$$

which is the diffusion. The same mechanism will be used in the following, with the difference that the equations cannot be solved in explicit form due to the nonlinearity.

In general the nonlinearity can be treated by perturbation expansion, if the amplitude can be considered small. This is an analogous procedure as that used in the field theory and leads to a series of terms represented by Feynman diagrams. We can separate in the Lagrangian the part that can

be explicitly integrated and make a perturbative treatment for the non-quadratic term. This is possible when we assume a particular (polynomial) form of the deterministic velocity, $V(x)$. Obviously, this term is $k(t)x(t)^3$ in Eq.(5). The functional integral can be written, taking account of this separation

$$Z_J = \exp \left[i \int_0^T dt (-b) \frac{\delta}{i\delta J_2(t)} \frac{\delta}{i\delta J_1(t)} \frac{\delta}{i\delta J_1(t)} \frac{\delta}{i\delta J_1(t)} \right] Z_J^{(q)} \quad (7)$$

where the remaining part in the Lagrangian is *quadratic*

$$Z_J^{(q)} = \int D[x(t)] D[k(t)] \exp \left[i \int dt \left(-k\dot{x} + akx + iDk^2 + J_1x + J_2k \right) \right] \quad (8)$$

The Euler-Lagrange equations are

$$\begin{aligned} \dot{k} &= -ak - J_1 \\ \dot{x} &= ax + 2iDk + J_2 \end{aligned}$$

The solutions can be expressed as follows

$$\begin{aligned} x(t) &= x_0 \exp(at) + \int_0^T dt' \Delta_{1j}(t, t') J_j(t') \\ k(t) &= \int_0^T dt' \Delta_{2j}(t, t') J_j(t') \end{aligned} \quad (9)$$

with

$$\begin{aligned} \Delta_{11}(t, t') &= \frac{iD}{(-a)} \exp(at) \\ &\times \{ [\exp(-2at) - 1] \Theta(t' - t) + [\exp(-2at') - 1] \Theta(t - t') \} \\ &\times \exp(at') \\ \Delta_{21}(t, t') &= \exp(-at) \Theta(t' - t) \exp(at') \\ \Delta_{12}(t, t') &= \exp(at) \Theta(t - t') \exp(-at') \\ \Delta_{22}(t, t') &= 0 \end{aligned} \quad (10)$$

The form of the generating functional derived from the quadratic part is

$$Z_J^{(q)} = \exp \left\{ i \int_0^T dt x_0 \exp(at) J_1(t) + \frac{i}{2} \int_0^T dt \int_0^T dt' J_i(t) \Delta_{ij}(t, t') J_j(t') \right\} \quad (11)$$

The occurrence of the first term in the exponent is the price to pay for not making the expansion around x_0 . However, such an expansion would have produced two non-quadratic terms in the Lagrangian density: $(-3bx_0)\varepsilon^2k$ and $(-b)\varepsilon^3k$. This would render the perturbative expansion extremely complicated since we would have to introduce two vertices : one, of order four, is that shown in Eq.(7) and another, of order three, related to the first of the nonlinearities mentioned above.

Even in the present case, the calculation appears very tedious. We have to expand the vertex part of Z_J as an exponential, in series of powers of the vertex operator. In the same time we have to expand the exponential in Eq.(11) as a formal series. Then we have to apply term by term the first series on the second series. The individual terms can be represented by diagrams. In this particular case we have a finite contribution even at the zero-loop order (the ‘‘tree’’ graph). It is however much more difficult to extract the statistics since we will need at least the diagrams leaving two free ends with currents J_1 .

In the case we examine here, the perturbative treatment is not particularly useful since the form of the potential (from which the velocity field is obtained) supports topologically distinct classes of saddle point solutions and this cannot be represented by a series expansion.

2.3 The Onsager-Machlup functional

To make comparison with other approaches, we take $J_{1,2} = 0$ and integrate over the functional variable k .

$$\begin{aligned} Z &= \int D[x(t)] D[k(t)] \exp \left\{ \int_0^T dt \left[-Dk^2 + i(-k\dot{x} + kV) \right] \right\} \\ &= \int D[x(t)] D[k(t)] \exp \left\{ - \int_0^T dt \left[\sqrt{D}k + \frac{i\dot{x} - iV}{2\sqrt{D}} \right]^2 + \int_0^T dt \frac{(i\dot{x} - iV)^2}{4D} \right\} \\ Z &= N_1 \int D[x(t)] \exp \left\{ - \frac{1}{4D} \int_0^T dt (\dot{x} - V)^2 \right\} \end{aligned}$$

In other notations

$$Z = N_1 \int D[x(t)] \exp \left[- \frac{S}{D} \right]$$

where

$$S = \int_0^T dt \frac{1}{4} (\dot{x} - V)^2$$

This is Eq.(25) of the reference Lehmann, Riemann and Hänggi, PRE62(2000)6282. In this reference it is called the Onsager-Machlup action functional and the analysis is based on this formula.

However, we can go further and we will find inconsistencies. We now take account of the fact that the velocity is derived from a potential

$$\begin{aligned} V[x(t)] &= -\frac{dU[x(t)]}{dx} \\ &\equiv -U'[x(t)] \end{aligned}$$

$$\begin{aligned} S &= \int_0^T dt \frac{1}{4} \left(\dot{x}^2 + 2\dot{x}U' + U'^2 \right) \\ &= \int_0^T dt \left[\frac{1}{4} \left(\dot{x}^2 + U'^2 \right) + \frac{1}{2} \frac{dU}{dt} \right] \\ &= \frac{1}{2} [U(T) - U(0)] + \int_0^T dt \left[\frac{1}{4} \left(\dot{x}^2 + U'^2 \right) \right] \end{aligned}$$

This leads to the form of the generating functional

$$Z = \frac{\exp \left[-\frac{U(T)}{2D} \right]}{\exp \left[-\frac{U(0)}{2D} \right]} K(x, t; x_i, t_i)$$

with

$$\begin{aligned} K(x, t; x_i, t_i) &= \int D[x(t)] \exp \left(-\frac{S}{D} \right) \\ S &= \int_0^T dt \left[\frac{1}{4} \left(\dot{x}^2 + U'^2 \right) \right] \end{aligned} \quad (12)$$

These are almost identical to the formulas (2-5) of the reference [32] (except that $\varepsilon \rightarrow 2D$). Also, it is quite close of the Eqs.(7a-7c) of the ref.[31].

However there is an important difference.

There is a term missing in Eq.(12) which however is present in the two above references. The full form of the action S , instead of Eq.(12) is

$$\begin{aligned} S &= \int_0^T dt \left(\frac{1}{4} \dot{x}^2 + W \right) \\ W &= \frac{U'^2}{4} - \frac{D}{2} U'' \end{aligned}$$

This term comes from the *Jacobian* that is hidden in the functional δ integration.

2.4 Connection between the MSR formalism and Onsager-Machlup

In our approach the most natural way of proceeding with a stochastic differential equation is to use the MSR type reasoning in the Jensen reformulation. The equation is discretized in space and time and selected with δ functions in an ensemble of functions (actually in sets of arbitrary numbers at every point of discretization). The result is a functional integral. There is however a particular aspect that needs careful analysis, as mentioned in the previous Subsection. It is the problem of the Jacobian associated with the δ functions. This problem is discussed in Ref.[41].

The equation they analyse is presented in most general form as

$$\frac{\partial \phi_j(t)}{\partial t} = -(\Gamma_0)_{jk} \frac{\delta H}{\delta \phi_k(t)} + V_j[\phi(t)] + \theta_j$$

where the number of stochastic equations is N , H is functional of the fields, V_j is the streaming term which obeys a current-conserving type relation

$$\frac{\delta}{\delta \phi_j} V_j[\phi] \exp\{-H[\phi]\} = 0$$

The noise is θ_j .

The following generating functional can be written

$$Z_\theta = \int D[\phi_j(t)] \exp \int dt [l_j \phi_j(t)] \prod_{j,t} \delta \left(\frac{\partial \phi_j(t)}{\partial t} + K_j[\phi(t)] - \theta_j \right) J[\phi]$$

the functions $l_j(t)$ are currents,

$$K_j[\phi(t)] \equiv -(\Gamma_0)_{jk} \frac{\delta H}{\delta \phi_k(t)} + V_j[\phi(t)]$$

and $J[\phi]$ is the Jacobian associated to the Dirac δ functions in each point of discretization.

The Jacobian can be written

$$J = \det \left[\left(\delta_{jk} \frac{\partial}{\partial t} + \frac{\delta K_j[\phi]}{\delta \phi_k} \right) \delta(t-t') \right]$$

Up to a multiplicative constant

$$J = \exp \left(Tr \ln \left[\left(\frac{\partial}{\partial t} + \frac{\delta K}{\delta \phi} \right) \frac{\delta(t-t')}{\frac{\partial}{\partial t} \delta(t-t')} \right] \right)$$

or

$$J = \exp \left(\text{Tr} \ln \left[1 + \left(\frac{\partial}{\partial t} \right)^{-1} \frac{\delta K(t)}{\delta \phi(t)} \right] \right)$$

Since the operator $\left(\frac{\partial}{\partial t} \right)^{-1}$ is retarded, only the lowest order term survives after taking the trace

$$J = \exp \left[-\frac{1}{2} \int dt \frac{\delta K_j[\phi(t)]}{\delta \phi_j(t)} \right]$$

The factor 1/2 comes from value of the Θ function at zero.

In the treatment which preserves the dual function $\widehat{\phi}$ associated to ϕ in the functional, there is a part of the action

$$\widehat{\phi} K[\phi]$$

Then a $\widehat{\phi}$ and a ϕ of the same coupling term from $\widehat{\phi} K[\phi]$ close onto a loop. Since $G_{\widehat{\phi}\phi}$ is retarded, all these contributions vanish except the one with a single propagator line. This cancels exactly, in all orders, the part coming from the Jacobian.

Then it is used to ignore all such loops and together with the Jacobian.

We can now see that in our notation this is precisely the term needed in the expression of the action.

$$\begin{aligned} \phi(t) &\rightarrow x(t) \\ K_j[\phi(t)] &\rightarrow U'[x(t)] \\ \frac{\delta K_j[\phi(t)]}{\delta \phi_j(t)} &\rightarrow -U''[x(t)] \end{aligned}$$

and the action (12) is completed with the new term

$$\int_0^T dt \left(-\frac{D}{2} U'' \right)$$

Now the generating functional is

$$Z = \frac{\exp \left[-\frac{U(T)}{2D} \right]}{\exp \left[-\frac{U(0)}{2D} \right]} K(x, t; x_i, t_i)$$

with

$$K(x, t; x_i, t_i) = \int D[x(t)] \exp \left(-\frac{S}{D} \right)$$

and

$$S = \int_0^T dt \left(\frac{1}{4} \dot{x}^2 + W \right) \quad (13)$$

$$W = \frac{U^2}{4} - \frac{D}{2} U'' \quad (14)$$

Now the two expressions are identical with those in the references cited. This will be the starting point of our analysis.

In conclusion we have compared the two starting points in a functional approach: The one that uses *dual functions* $x(t)$ and $k(t)$, closer in spirit to MSR; And the approach based on Onsager-Machlup functional, traditionally employed for the determination of the probabilities [31], [32]. Either we keep $k(t)$ and ignore the Jacobian (the first approach) or integrate over $k(t)$ and include the Jacobian. The approaches are equivalent and, as we will show below, lead to the same results.

A final observation concerning the choice of one or another method: in the MSR method, the trajectories include the diffusion from the direct solution of the Euler-Lagrange equations. In the Onsager-Machlup method the paths extremizing the action are deterministic and the diffusion is introduced by integrating on a neighborhood in the space of function, around the deterministic motion.

3 The transition solutions (instantons)

3.1 Numerical trajectories

The equations for the saddle point trajectory are in complex so we extend also the variable in complex space

$$\begin{aligned} x &\rightarrow (x_R, x_I) \\ k &\rightarrow (k_R, k_I) \end{aligned}$$

The obtain a system of four nonlinear ordinary differential equations which can be integrated numerically.

A typical form of the solution $x(t)$ is similar to the *kink instanton* (*i.e.* the tanh function). The function $x(t)$ spends very much time in the region close to the equilibrium point; then it performs a fast transition to the neighbour equilibrium point, where it remains for the rest of the time interval.

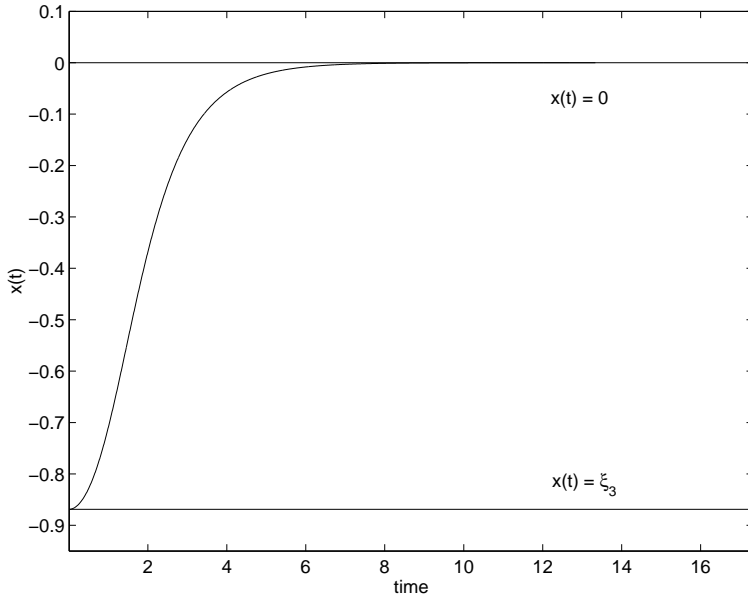

Figure 1: The kink-like instanton connecting a position close to the left (stable) equilibrium point to the middle $x = 0$ (unstable) equilibrium point in the effective potential $-W(x)$

3.2 Elliptic functions instantons (from Onsager-Machlup action)

The action functional Eqs.(13) and (14) leads to the following differential equation (which replaces Eqs.(6))

$$\frac{1}{2}\ddot{x} = \left(\frac{3b^2}{2}\right)x^5 + (-2ab)x^3 + \left(\frac{a^2}{2} - 3Db\right)x$$

Multiplying by \dot{x} and integrating we have

$$\dot{x} = \pm [b^2x^6 + (-2ab)x^4 + (a^2 - 6Db)x^2 + c_1]^{1/2} \quad (15)$$

We are interested in the functions $x(t)$ that has the following physical property: they stay for very long time stuck to the equilibrium points and perform a fast jump between them at a certain moment of time. Then we can take $c_1 = 0$. The solution can be obtained from the integration

$$\int_x^{x_q} \frac{d\xi}{\xi \sqrt{\xi^4 + (-2a/b)\xi^2 + a^2/b^2 - 6D/b}} = \pm bt + c_2$$

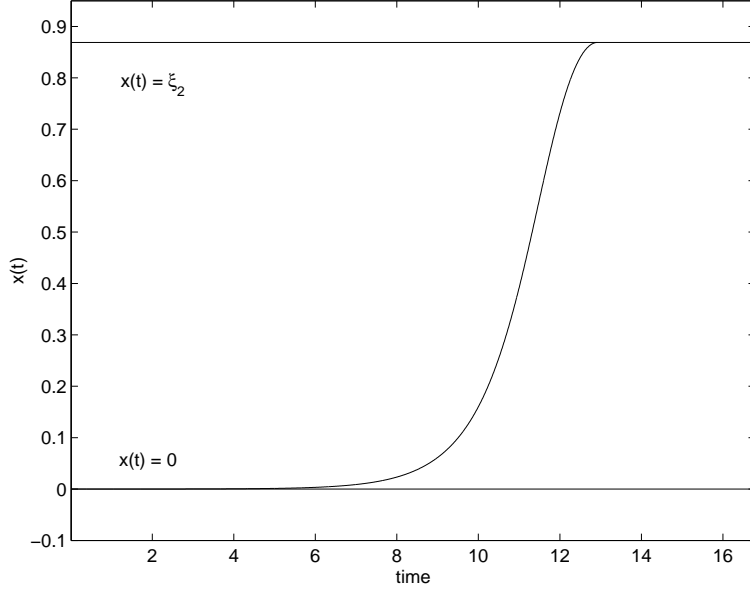

Figure 2: The kink-like instanton connecting the middle $x = 0$ (unstable) equilibrium point with a position close to the right (stable) equilibrium point to in the effective potential $-W(x)$

The upper limit x_q will be specified later. For the next calculation it will be taken as the smallest of the roots of the polynomial under the square root.

The details of the calculations in terms of elliptic functions can be found in *Byrd and Friedman* [42].

The roots of the fourth degree polynomial will be noted

$$\xi^4 + (-2a/b)\xi^2 + a^2/b^2 - 6D/b = (\xi_1 - \xi)(\xi_2 - \xi)(\xi_3 - \xi)(\xi_4 - \xi)$$

where

$$\begin{aligned} \xi_1 &= \sqrt{\alpha_1 + \alpha_2} & \xi_3 &= -\sqrt{\alpha_1 - \alpha_2} \\ \xi_2 &= \sqrt{\alpha_1 - \alpha_2} & \xi_4 &= -\sqrt{\alpha_1 + \alpha_2} \end{aligned}$$

such as to have $\xi_1 > \xi_2 > \xi_3 > \xi_4$; then we will use $x_q \equiv \xi_4$. The notations are

$$\alpha_1 \equiv a/b, \quad \alpha_2 \equiv \sqrt{6D/b}$$

The following substitutions are required

$$\begin{aligned} sn^2 u &= \frac{(\xi_1 - \xi_3)(\xi_4 - \xi)}{(\xi_1 - \xi_4)(\xi_3 - \xi)} \\ k^2 &= \frac{(\xi_2 - \xi_3)(\xi_1 - \xi_4)}{(\xi_1 - \xi_3)(\xi_2 - \xi_4)} \\ g &= \frac{2}{\sqrt{(\xi_1 - \xi_3)(\xi_2 - \xi_4)}} \end{aligned}$$

a new variable is introduced identifying the lower limit of the integral, $x \rightarrow u_1$

$$\begin{aligned} \alpha^2 &= \frac{\xi_1 - \xi_4}{\xi_1 - \xi_3} > 1 \\ \varphi &= am u_1 = \arcsin \sqrt{\frac{(\xi_1 - \xi_3)(\xi_4 - x)}{(\xi_1 - \xi_4)(\xi_3 - x)}} \\ sn u_1 &= \sin \varphi \end{aligned}$$

The integral can be written

$$\begin{aligned} &\int_x^{\xi_4} \frac{d\xi}{\xi \sqrt{(\xi_1 - \xi)(\xi_2 - \xi)(\xi_3 - \xi)(\xi_4 - \xi)}} \\ &= \frac{g}{\xi_4} \int_0^{u_1} \frac{1 - \alpha^2 sn^2(u)}{1 - \frac{\xi_3 \alpha^2}{\xi_4} sn^2(u)} du \end{aligned}$$

This integral can be expressed in terms of *elliptic* functions. We take $p \equiv \frac{\xi_3 \alpha^2}{\xi_4}$

$$\begin{aligned} &\int_0^{u_1} \frac{1 - \alpha^2 sn^2(u)}{1 - p sn^2(u)} du \\ &= \frac{1}{p^6} \left[\alpha^6 u + 3\alpha^4 (p^2 - \alpha^2) V_1 + 3\alpha^2 (p^2 - \alpha^2)^2 V_2 + (p^2 - \alpha^2)^3 V_3 \right] \end{aligned}$$

Here the notations are

$$\begin{aligned} V_1 &= \int \frac{du}{1 - p^2 sn^2(u)} = \Pi(\varphi, p^2, k) \\ V_2 &= \int \frac{du}{(1 - p^2 sn^2(u))^2} \\ &= \frac{1}{2(p^2 - 1)(k^2 - p^2)} \left[p^2 E(u) + (k^2 - p^2) u + \right. \\ &\quad \left. + (2p^2 k^2 + 2p^2 - p^4 - 3k^2) \Pi(\varphi, p^2, k) - \frac{p^4 sn(u) cn(u) dn(u)}{1 - p^2 sn^2(u)} \right] \end{aligned}$$

$$\begin{aligned}
V_3 = & \frac{1}{4(1-p^2)(k^2-p^2)} \left[k^2 V_0 + \right. \\
& + 2(p^2 k^2 + p^2 - 3k^2) V_1 + \\
& + 3(p^4 - 2p^2 k^2 - 2p^2 + 3k^2) V_2 + \\
& \left. - \frac{p^4 \operatorname{sn}(u) \operatorname{cn}(u) \operatorname{dn}(u)}{(1-p^2 \operatorname{sn}^2(u))^2} \right]
\end{aligned}$$

and

$$V_0 = \int du = u = F(\varphi, k) = \int \frac{d\varphi}{\sqrt{1 - k^2 \sin^2 \varphi}}$$

The symbol $\Pi(\varphi, p^2, k) \equiv \Pi(u, p^2)$ represents the Legendre's incomplete elliptic integral of the third kind and $\varphi = \operatorname{am}(u)$ is the amplitude of u . The symbols sn , cn , dn represent the Jacobi elliptic functions.

3.3 Typical instanton solutions

There are several well known examples of instantons. They appear in physical systems whose lowest energy state is degenerate and the minima of the action functional (or the energy, for stationary solutions) are separated by energy barriers. Instantons connect these minima by performing transitions which are only possible in imaginary time (the theory is expressed in Euclidean space, with uniform positive metric). It is only by including these instantons that the action functional is correctly calculated and real physical quantities can be determined.

From this calculation we can obtain the explicit trajectories that extremize the action functional and in the same time reproduce the jump of the system between the two distant equilibrium positions. These trajectories will be necessary in the calculation of the functional integral. However, since we have eliminated the external currents and integrated over the dual functional variable $k(t)$ we cannot derive the statistical properties of $x(t)$ from a generating functional.

3.4 Approximations of the instanton form

In the approach based on the Onsager-Machlup action the instanton is not used in its explicit form (elliptic functions) in the calculation of the action. The reason is that the result can be proved to depend essentially on local properties of the potential $V(x)$. This will be shown later.

In the approach with dual functions, one can reduce the instanton to its simplest form, an instantaneous transition between two states, a jump

appearing at an arbitrary moment of time. Using this form as a first approximation we will calculate the solutions of the Euler-Lagrange equations and then the action.

4 Fluctuations around the saddle point (instanton) solution

4.1 The expansion of the action functional around the extrema

Using the Onsager-Machlup action we have

$$P(x, t; x_i, t_i) = \exp \left[-\frac{U(x) - U(x_i)}{2D} \right] K(x, t; x_i, t_i)$$

The new function K has the expression

$$K(x, t; x_i, t_i) = \int_{x_i}^x D[x(\tau)] \exp \left(-\frac{1}{D} \int_{t_i}^t d\tau \left[\frac{\dot{x}^2}{4} + W(x) \right] \right) \quad (16)$$

The integrand at the exponent can be considered as the Lagrangean density for a particle of mass $1/2$ moving in a potential given by

$$\text{potential} = -W(x)$$

In a semiclassical treatment (similar to the quantum problem, where \hbar is the *small* diffusion coefficient D of the present problem), the most important contribution comes from the neighborhood of the classical trajectories, $x_c(\tau)$ that extremalizes the action S .

The “classical” equation of motion is

$$\begin{aligned} \frac{1}{2} \ddot{x}_c &= \left. \frac{dW(x)}{dx} \right|_{x=x_c} \\ x_c(t_i) &= x_i, \quad x_c(t) = x \end{aligned} \quad (17)$$

To take into account the trajectories in a functional neighborhood around $x_c(\tau)$ we expand the action to second order introducing the new variables

$$y(\tau) = x(\tau) - x_c(\tau)$$

This gives

$$K(x, t; x_i, t_i) = \exp \left[-\frac{1}{D} S_c(x, t; x_i, t_i) \right] \\ \times \int_{y(t_i)=0}^{y(t)=0} D[y(\tau)] \exp \left\{ -\frac{1}{D} \int_{t_i}^t d\tau \left[\frac{1}{4} \dot{y}^2 + \frac{1}{2} y^2 W''(x_c(\tau)) \right] \right\}$$

The deviation of the action from that obtained at the extremum $x_c(\tau)$, can be rewritten

$$\delta S = \frac{1}{2} \int_{t_i}^t d\tau y(\tau) \left[-\frac{1}{2} \frac{d^2}{d\tau^2} + W''(x_c(\tau)) \right] y(\tau)$$

The functional integration can be done since it is Gaussian and the result is

$$\sim \frac{1}{[\det(-\frac{1}{2} \frac{d^2}{d\tau^2} + W''(x_c(\tau)))]^{1/2}}$$

In order to calculate the determinant, one needs to solve the eigenvalue problem for this operator

$$\left[-\frac{1}{2} \frac{d^2}{d\tau^2} + W''(x_c(\tau)) \right] y_n(\tau) = \lambda_n y_n(\tau)$$

with the eigenfunctions verifying the conditions

$$y_n(t_i) = y_n(t) = 0 \\ \int_{t_i}^t d\tau y_n(\tau) y_m(\tau) = \delta_{nm}$$

The formal result for K is (also Van Vleck)

$$K(x, t; x_i, t_i) = N \frac{1}{(\prod_n \lambda_n)^{1/2}} \exp \left[-\frac{S_c}{D} \right]$$

where N is a constant that will be calculated by normalizing P . Another way to calculate N is to fit this result to the known *harmonic oscillator* problem.

It has been shown (Coleman) that the factor arising from the determinant can be written in the form

$$N \frac{1}{(\prod_n \lambda_n)^{1/2}} \simeq \frac{1}{[4\pi D \psi(t)]^{1/2}}$$

where the function ψ is the solution of

$$-\frac{1}{2} \frac{d^2\psi}{d\tau^2} + W''(x_c(\tau)) \psi = 0$$

with the boundary conditions

$$\begin{aligned} \psi(t_i) &= 0 \\ \left. \frac{d\psi}{d\tau} \right|_{t=t_i} &= 1 \end{aligned}$$

In the case where there are degenerate minima in $W(x)$ the particle can travel from one minimum to another. These solutions are called instantons. Consider for example the potential with two degenerate maxima of $-V(x)$ at $\pm a$ and with a minimum at $x = 0$. We want to calculate the probability $P(a, t/2; -a, -t/2)$.

The classical solution connecting the point $-a$ to the point a is a *kinklike* instanton. The energy of this solution is exponentially small

$$\begin{aligned} E &= \frac{1}{4} \dot{x}^2 - W \\ &\simeq 2W_a'' a^2 \exp \left[-t (2W_a'')^{1/2} \right] \end{aligned}$$

This solution spends quasi-infinite time in both harmonic regions around $\pm a$ where it has very small velocity; and travels very fast, in a short time Δt between these points (this is the time-width of the instanton).

The special effect of the translational symmetry in time is seen in the presence of the parameter representing the center of the instanton. It can be any moment of time between $-t/2$ and $t/2$. This case must be treated separately and we note that this corresponds to the lowest eigenvalue in the spectrum, since the range of variation of the coefficient in the expansion of any solution in terms of eigenfunction is the inverse of the eigenvalue

$$\delta c_n = \left(\frac{D}{\lambda_n} \right)^{1/2}$$

The widest interval, for the variation of the center of the instanton, must be associated with the smallest eigenvalue and this and its eigenfunction must be known explicitly. Instead of a precise knowledge of the lowest eigenvalue and its corresponding eigenfunction we will use an approximation, exploiting the fact the function $\dot{x}_c(t)$ is very close of what we need.

We start by noting that $\dot{x}_c(t)$ is a solution of the eigenvalue problem for the operator of second order functional expansion around the instanton. This eigenfunction corresponds to the eigenvalue 0

$$-\frac{1}{2} \frac{d^2}{d\tau^2} \dot{x}_c(t) + W''(x_c(\tau)) \dot{x}_c(t) = 0$$

and has boundary conditions

$$\dot{x}_c\left(\pm \frac{t}{2}\right) \sim \text{exponential small}$$

very close to 0, which is the exact boundary condition we require from the eigenfunctions of the operator. So the difference between $\dot{x}_c(t)$ and the true eigenfunction are very small. Since $\dot{x}_c(t)$ corresponds to eigenvalue 0 we conclude that, by continuity, the true eigenfunction will have an eigenvalue $\lambda_0(t)$ very small, exponentially small. Then the range of important values of the coefficient c_0 is very large and the Gaussian expansion is invalid since the departure of such a solution from the classical one (the instanton) cannot be considered small.

The degeneracy in the moment of time where the center of the instanton is placed (*i.e.* the moment of transition) can be solved treating this parameter as a collective coordinate. The result is

$$K(a, t/2; -a, -t/2) = \left[\frac{\lambda_0(t)}{4\pi D \psi(t/2)} \right]^{1/2} \int_{-t/2}^{t/2} d\theta \left\{ \frac{S[x_I(\tau - \theta)]}{4\pi D} \right\}^{1/2} \\ \times \exp \left\{ -\frac{1}{DS[x_I(\tau - \theta)]} \right\}$$

the parameter τ in the expression of the instanton solution shows is the current time variable along the solution that is used to calculate the action. The integration is performed on the intermediate transition moment θ . We also note that

$$S[x_I(\tau - \theta)] = \lim_{t \rightarrow \infty} S[x_I(\tau)] = S_0$$

since, except for the very small intervals (approx. the width of the instanton) at the beginning and the end of the interval $(-\frac{t}{2}, \frac{t}{2})$, the value of the action S is not sensitive to the position of the transition moment.

$$K(a, t/2; -a, -t/2) = \left[\frac{\lambda_0(t)}{4\pi D \psi(t/2)} \right]^{1/2} \left(\frac{S_0}{4\pi D} \right)^{1/2} t \exp \left(-\frac{S_0}{D} \right)$$

The instanton degeneracy introduces a *linear* time dependence of the probability.

In general, for a function $U(x)$ that has two minima separated by a barrier (a maximum) the potential $W(x)$ calculated from the action will have three minima and these are not degenerate. The inverse of this potential, $-W(x)$, which appears in the equation of motion, will have three maxima in general nondegenerate and the differences in the values of $-W(x)$ at these maxima is connected with the presence of the term containing D . Since we assume that D is small, the non-degeneracy is also small. The previous discussion in which the notion of instanton was introduced and K was calculated, take into consideration the degenerate maxima and the instanton transition at equal initial and final W .

Let us consider the general shape for $-W(x)$ with three maxima, at $x = b, 0$ and a . The heights of these maximas are

$$\begin{aligned} \frac{DU''_\alpha}{2}, \alpha &= b, 0, a \\ U''_b &> 0, U''_a > 0, U''_0 < 0 \end{aligned} \tag{18}$$

This is because the extrema of $-W(x)$

$$\frac{d[-W(x)]}{dx} = 0$$

coincides according to the equation of motion to the points where

$$\ddot{x} = 0, \text{ or } \dot{x}(t) = \text{const}$$

and the constant cannot be taken other value but zero

$$\dot{x}(t) = \text{const} = 0$$

Then, since we have approximately that $\dot{x} \approx V(x)$ (for small D) then we have that at these extrema of $-W(x)$ we have $V(x) = 0$ and only the second term in the expression of $W(x)$ remains. This justifies Eq.(18).

It will also be assumed that $U''_b > U''_a$.

4.2 The harmonic region (diffusion around the equilibrium points)

4.2.1 Contribution from the trivial fixed point solutions

We want to calculate, on a Kramers time scale, $\tau_K \sim \exp(\Delta U/D)$ the probability

$$P(b, t; b, 0) = P\left(b, \frac{t}{2}; b, -\frac{t}{2}\right) = K\left(b, \frac{t}{2}; b, -\frac{t}{2}\right)$$

We have to find the classical solution of the equation of motion connecting $(b, -\frac{t}{2})$ with $(b, \frac{t}{2})$. This is the trivial solution, particle sitting at b

$$x_c(t) = b$$

We have to calculate explicitly the form of the propagator in this case

$$K(x, t; x_i, t_i) = N \frac{1}{(\prod_n \lambda_n)^{1/2}} \exp \left[-\frac{S_c}{D} \right]$$

We use the formulas given before

$$N \frac{1}{(\prod_n \lambda_n)^{1/2}} \simeq \frac{1}{[4\pi D \psi(t)]^{1/2}} \quad (19)$$

where the function ψ is the solution of

$$-\frac{1}{2} \frac{d^2 \psi}{d\tau^2} + W''(x_c(\tau)) \psi = 0 \quad (20)$$

with the boundary conditions

$$\begin{aligned} \psi(t_i) &= 0 \\ \frac{d\psi}{d\tau} \Big|_{t=t_i} &= 1 \end{aligned} \quad (21)$$

We use simply U' and U'' for the respective functions calculated at the fixed point b .

We have

$$\begin{aligned} W'' &= \frac{d^2}{dx^2} \left[\frac{1}{4} (U')^2 - \frac{D}{2} U'' \right] \\ &\approx \frac{1}{2} (U'')^2 + \text{terms of order } D \end{aligned}$$

The equation for the eigenvalues becomes

$$\psi'' - (U'')^2 \psi = 0$$

$$\psi(t) = a_1 \exp(|U''|t) + a_2 \exp(-|U''|t)$$

and it results from the boundary conditions

$$\begin{aligned} a_1 &= \frac{1}{2|U''|} \exp[-|U''|t_i] \\ a_2 &= -\frac{1}{2|U''|} \exp[|U''|t_i] \end{aligned}$$

Then

$$\psi(t) = \frac{1}{2|U''|} \{ \exp[|U''|(t-t_i)] - \exp[-|U''|(t-t_i)] \}$$

NOTE. This is the sinh which is obtained in the calculation of the ground level splitting by quantum tunneling for a particle in two-well potential.

Now we can calculate

$$\frac{1}{[4\pi D\psi(t)]^{1/2}} = \frac{1}{(4\pi D)^{1/2}} [2|U''|]^{1/2} \frac{\exp[-\frac{1}{2}|U''|(t-t_i)]}{(1 - \exp[-2|U''|(t-t_i)])^{1/2}}$$

It remains to calculate the action for this trivial trajectory $x_c(t) = b$

$$\begin{aligned} S_c &= \int_{t_i}^t dt \left[\frac{1}{4} \dot{x}_c^2 + W(x_c) \right] \\ &= \int_{t_i}^t dt W(x_c) \\ &= \int_{t_i}^t dt \left[\frac{1}{4} U'^2(x_c) - \frac{D}{2} U''(x_c) \right] \end{aligned}$$

Since the position of the extremum of W is very close (to order D) of the position where $V(x)$ is zero, and since $V = -U'$, we can take with good approximation the first term in the integrand zero. Then

$$S_c = -\frac{D}{2} \int_{t_i}^t dt U''(x_c) = -\frac{D}{2} U''(t-t_i)$$

We have to put together the two factors of the propagator and take into account that at b we have $U'' > 0$

$$\begin{aligned} K(x, t; x_i, t_i) &= \frac{1}{[4\pi D\psi(t)]^{1/2}} \exp\left[-\frac{S_c}{D}\right] \\ &= \left(\frac{U''}{2\pi D}\right)^{1/2} \frac{\exp[-\frac{1}{2}U''(t-t_i)]}{(1 - \exp[-2U''(t-t_i)])^{1/2}} \exp\left(\frac{1}{2}U''(t-t_i)\right) \\ K(x, t; x_i, t_i) &= \left(\frac{U''}{2\pi D}\right)^{1/2} \frac{1}{(1 - \exp[-2U''(t-t_i)])^{1/2}} \end{aligned}$$

The contribution to the action is

$$\begin{aligned} K^0\left(b, \frac{t}{2}; b, -\frac{t}{2}\right) &= \left(\frac{U''_b}{2\pi D}\right)^{1/2} \frac{1}{[1 - \exp(-2U''_b t)]^{1/2}} \\ &\simeq \left(\frac{U''_b}{2\pi D}\right)^{1/2} \quad (\text{at large } t) \end{aligned}$$

It should be noticed that no other classical solution exists since there are no turning points permitting the solution to come back to b .

4.2.2 Contribution from the trivial fixed point solution in the dual function approach

We apply the procedure described for the purely diffusive case to the case $V(x) \neq 0$ and for this we need the solution of the Euler-Lagrange equations. An approximation is possible if the diffusion coefficient is small. In this case the diffusion will take place around the equilibrium positions $-\sqrt{a/b}$ and $+\sqrt{a/b}$. Taking the equilibrium $x(t) = x_0 = \pm\sqrt{a/b}$ in the equation for $k(t)$ we have

$$k(t) = \int_0^T dt' \Delta_{21}(t, t') J_1(t') \quad (22)$$

where

$$\Delta_{21}(t, t') = \exp [(-a + 3bx_0^2)t] \Theta(t' - t) \exp [-(-a + 3bx_0^2)t'] \quad (23)$$

The symbol Θ stands for the Heaviside function. In the equation for $x(t)$ we expand around the equilibrium position

$$x = x_0 + \varepsilon(t) \quad (24)$$

and solve the equation

$$\dot{\varepsilon} = (a - 3bx_0^2)\varepsilon + 2iDk + J_2 \quad (25)$$

taking account of Eq.(22)

$$x(t) = x_0 + \int_0^T dt' \Delta_{11}(t, t') J_1(t') + \int_0^T dt' \Delta_{12}(t, t') J_2(t') \quad (26)$$

where

$$\begin{aligned} \Delta_{11}(t, t') &= (2iD) \exp [(a - 3bx_0^2)t] \\ &\times \left\{ \frac{1}{2(-a + 3bx_0^2)} (\exp [2(-a + 3bx_0^2)t] - 1) \Theta(t' - t) \right. \\ &\left. + \frac{1}{2(-a + 3bx_0^2)} (\exp [2(-a + 3bx_0^2)t'] - 1) \Theta(t - t') \right\} \\ &\times \exp [(a - 3bx_0^2)t'] \end{aligned} \quad (27)$$

and

$$\Delta_{12}(t, t') = \exp [(a - 3bx_0^2)t] \Theta(t - t') \exp [(-a + 3bx_0^2)t'] \quad (28)$$

We note that at the limit where no potential would be present, $(-a + 3bx_0^2) \rightarrow 0$, the propagators Δ become

$$\begin{aligned}\Delta_{11}(t, t') &\rightarrow 2iD [t\Theta(t' - t) + t'\Theta(t - t')] \\ \Delta_{12}(t, t') &\rightarrow \Theta(t - t')\end{aligned}$$

i.e. the propagators of a purely diffusive process (see [39]).

Using the solutions Eqs.(22) and (26) we can calculate the action along this path.

$$S_J = \int_0^T dt \left[-k\dot{x} + kV(x) + iDk^2 + J_1x + J_2k \right]$$

We will insert the expansion Eq.(24), perform an integration by parts over the first term and take into account the equations, *i.e.* the first line of Eq.(6) and Eq.(25)

$$\begin{aligned}S_J &= \int_0^T dt \left\{ -\frac{1}{2}k\dot{\varepsilon} + kV'(x_0)\varepsilon + iDk^2 + J_1x_0 + J_1\varepsilon \right. \\ &\quad \left. + \frac{1}{2}k[-V'(x_0) - J_1]\varepsilon + J_2k \right\} \\ S_J &= x_0 \int_0^T dt J_1 + \frac{1}{2} \int_0^T dt (\varepsilon J_1 + kJ_2)\end{aligned}$$

Now we express the two solutions, for $k(t)$ and $\varepsilon(t)$ in terms of the propagators Δ

$$S_J = x_0 \int_0^T dt J_1(t) + \frac{1}{2} \int_0^T dt \int_0^T dt' J_i(t) \Delta_{ij}(t, t') J_j(t') \quad (29)$$

where summation over $i, j = 1, 2$ is assumed, and $\Delta_{22}(t, t') \equiv 0$.

We now dispose of the generating functional of the system *when this is in a region around* $x_0 = \pm\sqrt{a/b}$, the fixed equilibrium points. To see what is the effect of the diffusion in this case we calculate for the variable $x(t)$ the average and the dispersion.

$$\langle x(t) \rangle = \frac{\delta}{i\delta J_1(t)} Z_J \Big|_{J_{1,2}=0} = x_0$$

which was to be expected. And

$$\langle x(t) x(t') \rangle = \frac{\delta}{i\delta J_1(t)} \frac{\delta}{i\delta J_1(t')} Z_J \Big|_{J_{1,2}=0}$$

$$\begin{aligned}
& \frac{\delta}{i\delta J_1(t)} \frac{\delta}{i\delta J_1(t')} Z_J \\
&= \frac{1}{2} \frac{1}{i} \Delta_{11}(t, t') \exp(iS_J) \\
&+ \left[x_0 + \frac{1}{2} \int_0^T dt' \Delta_{11}(t, t') J_1(t') + \frac{1}{2} \int_0^T dt' \Delta_{12}(t, t') J_2(t') + \frac{1}{2} \int_0^T dt'' J_2(t'') \Delta_{21}(t'', t) \right] \\
&\times \left[x_0 + \frac{1}{2} \int_0^T dt'' \Delta_{11}(t', t'') J_1(t'') + \frac{1}{2} \int_0^T dt'' \Delta_{12}(t', t'') J_2(t'') + \frac{1}{2} \int_0^T dt J_2(t) \Delta_{21}(t, t') \right] \\
&\times \exp(iS_J)
\end{aligned}$$

This gives the result

$$\begin{aligned}
\langle x(t) x(t') \rangle &= x_0^2 + \exp[(a - 3bx_0^2)t] D \tag{30} \\
&\times \left\{ \frac{1}{2(-a + 3bx_0^2)} (\exp[2(-a + 3bx_0^2)t] - 1) \Theta(t' - t) \right. \\
&+ \frac{1}{2(-a + 3bx_0^2)} (\exp[2(-a + 3bx_0^2)t'] - 1) \Theta(t - t') \left. \right\} \\
&\times \exp[(a - 3bx_0^2)t']
\end{aligned}$$

In the absence of the potential $a \rightarrow 0$ and $b \rightarrow 0$, this is simply

$$\langle x(t) x(t') \rangle = x_0^2 + D \min(t, t')$$

i.e. the diffusion around the position x_0 . In the present case, we note that $a - 3bx_0^2 \equiv V'(x_0) = -U''(x_0)$ with $U_0'' \equiv U''(x_0) > 0$. Fixing the parameters, we take $t > t'$ and obtain

$$\langle x(t) x(t') \rangle = x_0^2 + D \exp(-U_0''t) \frac{1}{2U_0''} [\exp(2U_0''t') - 1] \exp(-U_0''t')$$

For $t = t'$ (the dispersion) we obtain (with $\Theta \rightarrow 1/2$)

$$\langle x(t)^2 \rangle = x_0^2 + \left(\frac{D}{2U_0''} \right) [1 - \exp(-2U_0''t)] \tag{31}$$

It is straightforward to calculate the higher order statistics for this process, since the functional derivatives can easily be done. We have to remember that this derivation was based on the approximation consisting in taking the equilibrium position in the Euler-Lagrange equation for $k(t)$.

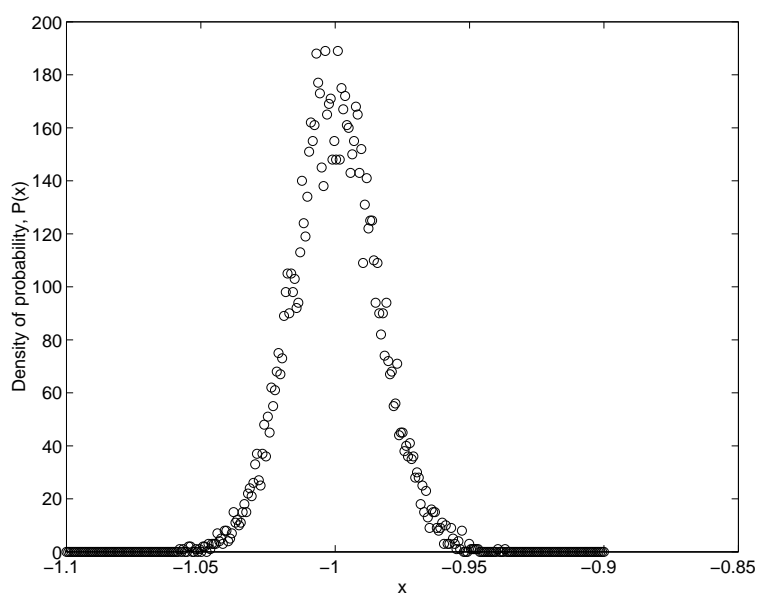

Figure 3: The probability distribution in the harmonic region around the left equilibrium stable point.

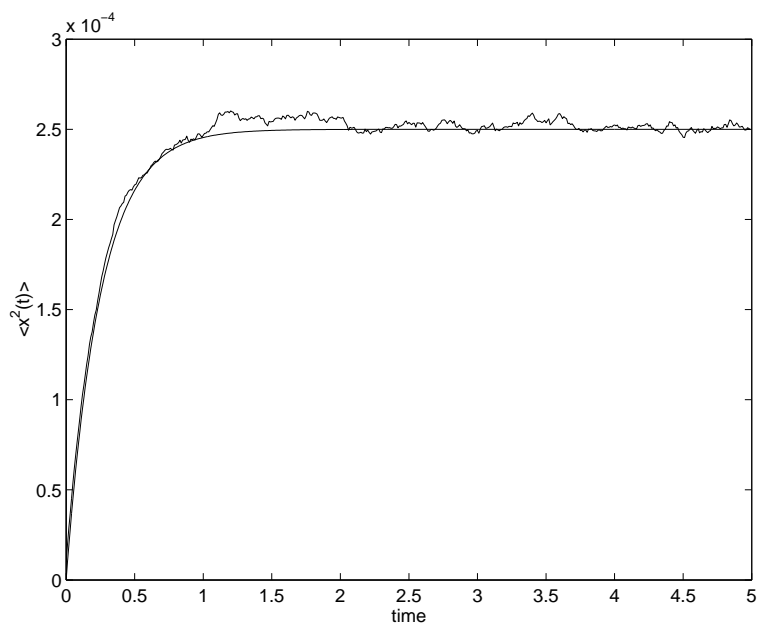

Figure 4: Comparison between the analytical formula Eq.(31) (continuous line) and numerical integration of the stochastic equation.

4.3 Assembling the instanton-anti-instanton solutions

4.3.1 The formulation based on Onsager-Machlup action

However, since $W(0) - W(b)$ and $W(a) - W(b)$ are small quantities and we can suppose that the instantons, even if they are not exact solutions of the equations of motion, can give a contribution to the action. The instantons connects the points of maximum not of $-W(x)$ (because they are not equal) but of a different potential, a *corrected* $-W(x)$ to order one in D that has degenerate maxima. This potential will be called $W^{(0)}(x)$ and it will be considered in the calculation of the contribution of the instantons and antiinstantons.

$$\begin{aligned} W^{(0)}(x) &= W(x) - \delta W(x) \\ \delta W(x) &= 0, \quad x < x_m \\ &= W_0 - W_b, \quad x > x_m \end{aligned}$$

where x_m is the point corresponding to the minimum situated between the two maximas.

It is introduced the family of trajectories $x_I(\tau - t_0)$ which leaves $x = b$ at time $-\infty$ and reach $x = 0$ at time ∞ . They have all the same energy

$$E = -W_b$$

and the classical action S_{b0} .

We now consider the travel from $x = b$ to $x = 0$ made by an instanton $x_I(\tau - t_0)$ with the center located at time t_0 ; next the return made by an antiinstanton which is actually an instanton $x_I(t_1 - \tau)$ starting from $x = 0$ and going to $x = b$ with the center located at time t_0 . With these two instantons we create a single classical solution

$$x_{IA}(\tau; t_0, t_1) = \begin{cases} x_I(\tau - t_0) & \tau < \frac{1}{2}(t_0 + t_1) \\ x_I(t_1 - \tau) & \tau > \frac{1}{2}(t_0 + t_1) \end{cases}$$

The contribution to the action of this *assambled* solution is

$$\begin{aligned} S_{IA}(t; t_0, t_1) &\simeq (W_0 - W_b)(t_1 - t_0) + W_b t + 2S_{b0} \\ &\quad - 2 \int_{(t_1+t_0)/2}^{\infty} d\tau \frac{[\dot{x}_I(\tau - t_0)]^2}{2} \end{aligned}$$

The contributions in this formula comes from the potential energy and the kinetic energy along the trajectory. We should remember that the action is

the integral on time of the density of Lagrangian, where there is the kinetic energy term and minus the potential energy.

$$S = \int dt \left\{ \frac{1}{2} \dot{x}^2 - [-W(x)] \right\}$$

If the particle would have remained in $x = b$ immobile for all time $(-t/2, t/2)$ then the contribution from the potential would have been

$$W(b) t$$

The instanton spends $(t_1 - t_0)$ time in the point 0 before returning to b . Then it accumulates the action equal with the difference in potential between b and 0 multiplied with this time interval.

$$[(-W_b) - (-W_0)](t_1 - t_0) = (W_0 - W_b)(t_1 - t_0)$$

(since $(-W_b) > (-W_0)$).

Define the kinetic energy and the energy

$$\begin{aligned} K &= \int_{t_0}^t \frac{1}{2} \dot{x}^2(t) dt \\ E &= \frac{1}{2} \dot{x}^2(t) + [-W(x)] \\ \dot{x}(t) &= \sqrt{2(E + W(x))} \end{aligned}$$

then

$$\begin{aligned} K &= \int_{t_0}^t (E + W(x)) dt = \int_{t_0}^t \frac{E + W(x)}{\dot{x}(t)} dx \\ &= \frac{1}{2} \int_{x_0}^x \sqrt{2(E + W(x))} dx \end{aligned}$$

In this formula we have to replace the expression of the trajectory $x_{IA}(t)$ and integrate.

In our case the energy has the value of the initial position. Here the velocity is zero and the potential is $-W(b)$

$$E|_{x=b} = -W(b)$$

and the potential is actually the current value of the zeroth -order potential

$$\begin{aligned} E + W(x) &= [-W(b)] - [-W^{(0)}(x)] \\ &= W^{(0)}(x) - W(b) \end{aligned}$$

If we want to calculate the integral of the *kinetic energy* along the trajectory, we have to consider separately the intervals where the kinetic energy is strongly determined by the velocity, *i.e.* the region where the instanton transition occurs, from the rest of the trajectory where, the velocity being practically zero, the potential is a better description and can be easily approximated. The approximation will rely on the fact that the particle is practically immobile in b or in 0 , after the transition has been made. So we will use both expressions for the kinetic energy

$$K|_{\substack{x=0 \\ x=b}} = \int_0^{\frac{t_1+t_0}{2}} dt \frac{1}{2} \dot{x}^2(t) + \int_b^0 dx [W^{(0)}(x) - W_b]^{1/2}$$

The terms must be considered twice and the interval of integration can be extended for the region of transition, since in any case it is very small

$$2 \int_b^0 dx [W^{(0)}(x) - W_b]^{1/2} - 2 \int_{\frac{t_1+t_0}{2}}^{\infty} d\tau \frac{1}{2} \dot{x}^2(\tau - t_0)$$

The term S_{b0} is

$$S_{b0} = \int_b^0 dx [W^{(0)}(x) - W_b]^{1/2}$$

Using an approximation for the form of the instanton, it results

$$\begin{aligned} S_{IA}(t; t_0, t_1) &= (W_0 - W_b)(t_1 - t_0) + W_b t + 2S_{b0} \\ &\quad - \frac{x_m^2 (W_0'')^{1/2}}{\sqrt{2}} \exp \left[(2W_0'')^{1/2} (2\Delta_{m0} - t_1 + t_0) \right] \end{aligned}$$

where

$$W_0'' = \left. \frac{d^2 W_0}{dx^2} \right|_{x=0}$$

and

$$\Delta_{m0} = \frac{1}{2} \int_{x_m}^0 dx \left\{ \frac{1}{[W^{(0)}(x) - W_b]^{1/2}} - \frac{1}{[W_h^{(0)}(x) - W_b]^{1/2}} \right\}$$

The local harmonic approximation to $W^{(0)}$ is $W_h^{(0)}$

$$W_h^{(0)} = \begin{cases} W_b + \frac{W_0''}{2} x^2 & x > x_m \\ W_b + \frac{W_b''}{2} (x - b)^2 & x < x_m \end{cases}$$

NOTE Since the trajectory $x_{IA}(\tau; t_0, t_1)$ is not an *exact* solution of the equation of motion in the potential W , the expansion of the action S will not be limited to the zeroth and the second order terms. It will also contain a first order term, $(\delta S/\delta x)|_{x=x_c(\tau)}$. It can be shown that this contribution is negligible in the order $O(D)$.

The calculation of the contribution to the functional integral from the second order expansion around x_{IA} is done as usual by finding the eigenvalues of the determinant of the corresponding operator. As before, the product of the eigenvalues should not include the first eigenvalue since this is connected with the translational symmetry of the instanton solution. This time there will be two eigenvalues, one for t_0 (the transition performed by the $b \rightarrow 0$ instanton) and the second for t_1 (the transition performed by the antiinstanton, or the transition $0 \rightarrow b$). Another way of expressing this invariance to the two time translations is to say that the pair of instantons has not a determined central moment and, in addition, there is an *internal* degree of freedom of the *breathing* solution, which actually is this pair instanton-antiinstanton.

To take into account these modes, whose eigenvalues are zero, we need to integrate in the functional integral, over the two times, t_0 and t_1 .

The measure of integration for the two translational symmetries t_0 and t_1 is

$$\frac{S_{b0}}{2\pi D}$$

This quantity is the Jacobian of the change of variables in the functional integration over the fluctuations around the instanton solution. The fluctuation that corresponds to the lowest (almost zero) eigenvalue is replaced in the measure of integration with the differential of the time variable representing the moment of transition. Then it results this Jacobian.

It can be shown that in the approximation given by exponentially small terms, the contribution to the path integral of the small fluctuations around the classical instanton-antiinstanton x_{IA} solution is the *product* of the fluctuation terms around the instanton and antiinstanton separately.

$$\begin{aligned} K^{(1)}\left(b, \frac{t}{2}; b, -\frac{t}{2}\right) &= \int_{-t/2}^{t/2} dt_0 \int_{t_0}^{t/2} dt_1 \left(\frac{S_{b0}}{2\pi D}\right) \\ &\times \left(\frac{\lambda_0}{4\pi D\psi}\right)_I^{1/2} \left(\frac{\lambda_0}{4\pi D\psi}\right)_A^{1/2} \\ &\times \left[\frac{2\pi D}{(2W_0'')^{1/2}}\right]^{1/2} \exp\left[-\frac{S_{IA}(t; t_0, t_1)}{D}\right] \end{aligned}$$

where $(\lambda_0)_{I,A}$ represent the lowest eigenvalue of the operator arising from the second order expansion of the action, defined on the time intervals

$$\begin{aligned} x_c(\tau) &\equiv x_I(\tau - t_0) , \quad -\frac{t}{2} < \tau < \frac{t_0 + t_1}{2} \\ x_c(\tau) &\equiv x_I(t_1 - \tau) , \quad \frac{t_0 + t_1}{2} < \tau < \frac{t}{2} \end{aligned}$$

The notation ψ_I and respectively ψ_A represents

$$\psi_I \text{ value at } \frac{t_0 + t_1}{2} \text{ of the eigenfunction } \psi \text{ that starts at } t_i = -\frac{t}{2}$$

$$\psi_A \text{ value at } \frac{t}{2} \text{ of the eigenfunction } \psi \text{ that starts at } t_i = \frac{t_0 + t_1}{2}$$

This corresponds to the formula of Coleman which replaces the infinite product of eigenvalues with $\left(\frac{\lambda_0}{4\pi D\psi}\right)^{1/2}$ where ψ is calculated at the end of the interval of time, where ψ verifies the boundary conditions (21).

The result is

$$\begin{aligned} &K^{(1)}\left(b, \frac{t}{2}; b, -\frac{t}{2}\right) \tag{32} \\ &= \left[\frac{2\pi D}{(2W_0'')^{1/2}}\right]^{1/2} \frac{(x_m - b) |x_m| W_0'' W_b''}{2\pi^2 D^2} \exp\left[-\frac{\varepsilon_0^{(b)} t}{D}\right] \\ &\quad \times \exp\left[-\frac{2S_{b0}}{D} + \Delta_{bm} (2W_b'')^{1/2} + \Delta_{bm} (2W_0'')^{1/2}\right] \\ &\quad \times \int_{-t/2}^{t/2} dt_0 \int_{t_0}^{t/2} dt_1 \exp\left\{-\frac{\varepsilon_0^{(0)} - \varepsilon_0^{(b)}}{D} (t_1 - t_0) + \frac{C}{D} \exp\left[-(2W_0'')^{1/2} (t_1 - t_0)\right]\right\} \end{aligned}$$

where

$$\varepsilon_0^{(b)} = W_i + D \left(\frac{W_i''}{2}\right)^{1/2}$$

is the lowest eigenvalue of the Schrodinger equation associated with the Fokker-Planck diffusion equation in the local harmonic approximation of the potential W in the well i .

$$C = x_m^2 \left(\frac{W_0''}{2}\right)^{1/2} \exp\left[2(2W_0'')^{1/2} \Delta_{m0}\right] \tag{33}$$

and

$$\Delta_{ij} = \frac{1}{2} \int_{x_i}^{x_j} dx \left\{ \frac{1}{[W^{(0)}(x) - W_b]^{1/2}} - \frac{1}{[W_h^{(0)}(x) - W_b]^{1/2}} \right\}$$

There is a very important problem with this formula: the coefficient C is positive and the contribution of this part in the t_1 integration comes from time intervals

$$t_1 - t_0 \ll \frac{1}{(2W_0'')^{1/2}} \sim \Delta t$$

Since this is a very small time interval, it results that the contributions are due to states where the instanton and the antiinstanton are very close one of the other, which is unphysical. It will be necessary to calculate in a particular way this part, introducing a contour in the complex $t_1 - t_0$ plane, with an excursion on the imaginary axis.

The calculation of the propagator $K^{(1)}\left(b, \frac{t}{2}; b, -\frac{t}{2}\right)$. Here (1) means that only one pair of instanton and anti-instanton is considered.

We particularize the formula above using the expression for $W(x)$ given in terms of $U(x)$. Now we have

$$\begin{aligned} W_b &= -\frac{DU_b''}{2} \\ W_0 &= -\frac{DU_0''}{2} \\ W_b &= -\frac{U_b''^2}{2} \\ W_0 &= -\frac{U_0''^2}{2} \end{aligned}$$

The expression of S_{b0} is

$$S_{b0} = \frac{U_0 - U_b}{2} + \frac{D}{2} \ln \left| \frac{U_b''(x_m - b)}{U_0''x_m} \right| + \frac{D}{2} (U_b''\Delta_{bm} + U_0''\Delta_{m0})$$

$$\begin{aligned} K^{(1)}\left(b, \frac{t}{2}; b, -\frac{t}{2}\right) &= \frac{U_b''|U_0''|x_m^2}{2} \left(\frac{|U_0''|}{2\pi D}\right)^{3/2} I(t) \\ &\quad \times \exp\left(-\frac{U_0 - U_b}{D} + 2\Delta_{m0}|U_0''|\right) \end{aligned}$$

where

$$I(t) = \int_{-t/2}^{t/2} dt_0 \int_C dz \exp\left[-|U_0''|z + \frac{C}{D} \exp(-|U_0''|z)\right]$$

4.3.2 The formulation using dual functions

We will use the functional approach in the setting that has been developed by us to the calculation of the probability of transition from one minimum to the same minimum with an intermediate stay at the unstable maximum point (symmetric potential).

The initial equation is

$$\dot{x}(t) = V(x) + \xi(t)$$

The action functional with external current added is

$$S = i \int_{-T}^T dt L$$

$$L = -k(t) \dot{x}(t) + k(t) V(x) + i D k^2(t) + J_1(t) x(t)$$

The equations of motion are

$$\begin{aligned} \dot{x} - V(x) - 2i D k &= 0 \\ \dot{k} - k \left(\frac{dV}{dx} \right) &= -J_1 \end{aligned}$$

We have to solve these equations, and replace the solutions $x(t)$ and $k(t)$ in the action functional. Then the functional derivatives to the external current $J_1(t)$ will give us the correlations for the stochastic variable $x(t)$. We can also calculate the probability that the particle, starting from one point at a certain time will be found at another point at other time. This will be done below.

The first step is to obtain an analytical solution to the Euler-Lagrange equation. The method to solve these equation is essentially a successive approximation, as we have done above, for the diffusive motion around a stable position in the potential (harmonic region). We know that the classical trajectory must be of the type of a transition between the initial point, taken here as the left minimum of the potential and the final point, the unstable maximum of the potential. From there, the particle will return to the left minimum by an inverse transition. We have to calculate simultaneously $x(t)$ and $k(t)$, but we have sufficient information to find an approximation for $x(t)$, by neglecting the effect of diffusion (the last term in the differential equation for $x(t)$).

$$\dot{x} = ax - bx^3$$

This gives

$$x(\tau) = \pm \sqrt{\frac{a}{b} \frac{1}{\{1 + \exp[-2a(\tau - t_0)]\}}^{1/2}}$$

This solution is a transition between either of the minima $\pm\sqrt{a/b}$ and 0. It shows the same characteristics as found numerically or by integrating the elliptic form of the equation, in the case of Onasger-Machlup action. The particle spends long time in the initial and final points and makes a fast transition between them at an arbitrary time t_0 . The width of transition is small compared to the rest of quasi-immobile stays in the two points, especially if a is large. Then we will make an approximation, taking the solution as

$$x_{\eta}^{(1)}(\tau) = -\sqrt{\frac{a}{b}}\Theta(t_0 - \tau) + 0 \times \Theta(\tau - t_0)$$

where $-\sqrt{a/b}$ and 0 are the initial and final positions, the indice η means that this is the classical solution (extremum of the action) and (1) means the first part of the full trajectory, which will also include the inverse transition, from 0 to $-\sqrt{a/b}$. The following structure of the total trajectory is examined: The total time interval is between $-T$ and T (later the parameter T will be identified with $-t/2$ for comparison with the results from the literature). The current time variable is τ and in the present notations, t is any moment of time in the interval $(-T, T)$. At time t_0 the particle makes a jump to the position $x = 0$ and remains there until $\tau = t_1$. At t_1 it performs a jump to the position $-\sqrt{a/b}$, where it remains for the rest of time, until T .

With this approximative solution of the Euler-Lagrange equations (since we have neglected the term with D in the equation of $x(\tau)$) we return to the equation for $k(\tau)$. We first calculate

$$\left. \frac{dV}{dx} \right|_{x_{\eta}^{(1)}(\tau)} = (-2a)\Theta(t_0 - \tau) + a\Theta(\tau - t_0)$$

We need the integration of this quantity in the inverse direction starting from the end of the motion toward the initial time

$$\int_T^t d\tau \left(\frac{dV}{dx} \right)_{x_{\eta}^{(1)}(\tau)} = [-a(T - t)]\Theta(t - t_0) + [-aT + 3at_0 - 2at]\Theta(t_0 - t)$$

We now introduce the second part of the motion: at time $\tau = t_1$ the particle makes the inverse transition

$$x_{\eta}^{(2)}(\tau) = 0 \times \Theta(t_1 - \tau) + \left(-\sqrt{\frac{a}{b}} \right) \Theta(\tau - t_1)$$

with the similar quantities.

After explaining the steps of the calculation, we change to work with the full process, assembling the two transitions and the static parts into a single trajectory

$$\begin{aligned} x_\eta(\tau) &= x_\eta^{(1)}(\tau) + x_\eta^{(2)}(\tau) \\ &= \left(-\sqrt{\frac{a}{b}}\right) \Theta(t_0 - \tau) + \left(-\sqrt{\frac{a}{b}}\right) \Theta(\tau - t_1) \end{aligned}$$

$$\left. \frac{dV}{dx} \right|_{x_\eta(\tau)} = (-2a) \Theta(t_0 - \tau) + a \Theta(t_1 - \tau) \Theta(\tau - t_0) + (-2a) \Theta(\tau - t_1)$$

and

$$\int_T^t d\tau \left(\frac{dV}{dx} \right)_{x_\eta^{(1)}(\tau)} = W(t)$$

We have introduced the notation

$$\begin{aligned} W(t) &\equiv (2a)(T - t) \Theta(t - t_1) \\ &\quad + (2aT - 3at_1 + at) \Theta(t - t_0) \Theta(t_1 - t) \\ &\quad + (2aT - 3at_1 + 3at_0 - 2at) \Theta(t_0 - t) \end{aligned} \tag{34}$$

Then the solution of the equation for the dual variable is

$$k_\eta(\tau) = \exp[-W(\tau)] \left\{ k_T + \int_T^\tau dt' [-J_1(t')] \exp[W(t')] \right\}$$

According to the procedure explained before we will need to express the solutions as bilinear combinations of currents, so we identify

$$\Delta_{21}(t, t') = \Theta(t' - t) \exp[-W(t)] \exp[W(t')] \tag{35}$$

and the solution can be rewritten

$$k_\eta(\tau) = k_T \exp[-W(\tau)] + \int_{-T}^T dt' \Delta_{21}(t, t') J_1(t') \tag{36}$$

Using these first approximations for the extremizing path $(x_\eta(\tau), k_\eta(\tau))$ we return to the Euler Lagrange equations and expand the variable x as

$$x(\tau) = x_\eta(\tau) + \delta x(\tau) \tag{37}$$

whose equation is

$$\dot{\delta x}(\tau) = 2iDk_\eta(\tau) + \left(\frac{dV}{dx} \right)_{x_\eta(\tau)} \delta x(\tau)$$

and the solution

$$\delta x(t) = \exp \left[\int_0^t d\tau \left(\frac{dV}{dx} \right)_{x_\eta(\tau)} \right] \left\{ B_0 + \int_0^t dt' 2iDk_\eta(t') \exp \left[- \int_0^{t'} dt'' \left(\frac{dV}{dx} \right)_{x_\eta(t'')} \right] \right\}$$

Here B_0 is a constant to be determined by the condition that δx vanishes at the final point. We note that here all integrations are performed forward in time. We also notice that this expression will contain the current J_1 and we will introduce the propagator Δ_{11} . Performing the detailed calculations we obtain

$$\begin{aligned} \delta x(t) &= B_0 \exp [W(t)] + \exp [W(t)] \int_{-T}^T dt' (2iDk_T) \Theta(t-t') \exp [-W(t')] \\ &\quad + \int_{-T}^T dt' \Delta_{11}(t, t') J_1(t') \end{aligned} \quad (\mathfrak{B}\mathfrak{B})$$

The first two terms depend on constants of integrations and the propagator is

$$\Delta_{11}(t, t') = \exp [W(t)] \int_{-T}^T dt'' 2iD\Theta(t-t'') \Delta_{21}(t'', t') \exp [-W(t'')] \quad (39)$$

Using the solutions (37) and (36) we can calculate the action along this trajectory.

$$\begin{aligned} S &= i \int_{-T}^T dt \left(-k\dot{x} + kV + iDk^2 + J_1x \right) \\ &= i \int_{-T}^T dt \left[\frac{1}{2} \left(-k\dot{x} + kV + 2iDk^2 \right) + \frac{1}{2} \left(-k\dot{x} + kV \right) + J_1x \right] \\ &= i \int_{-T}^T dt \left(\frac{1}{2}x\dot{k} + \frac{1}{2}kV + J_1x \right) \\ &= i \int_{-T}^T dt \left[\frac{1}{2}x \left(-J_1 + k \frac{dV}{dx} \right) + \frac{1}{2}kV + J_1x \right] \\ &= i \int_{-T}^T dt \left\{ \frac{1}{2}J_1x + \frac{1}{2}k \left[V - \left(\frac{dV}{dx} \right) x \right] \right\} \end{aligned}$$

[It becomes obvious that when the potential is linear (which means that the Lagrangean is quadratic the two functional variables $x(t)$ and $k(t)$) the potential does not contribute to the action along the extremal path].

Using the solutions we have

$$S = i \int_{-T}^T dt \frac{1}{2} J_1(t) [x_\eta(t) + \delta x(t)] \\ + i \int_{-T}^T dt \frac{1}{2} \left[V(x_\eta) - \left(\frac{dV}{dx} \right)_{x_\eta} x_\eta \right] i \int_{-T}^T dt' \Delta_{21}(t, t') J_1(t')$$

It will become clear later that the parts containing constants are not significant for the final answer, the probability. We will focus on the terms containing explicitly the current J_1 since the statistical properties are determined by functional derivatives to this parameter. The action is

$$S = i \int_{-T}^T dt \left\{ \frac{1}{2} J_1(t) x_\eta(t) \right. \\ \left. + \frac{1}{2} J_1(t) \int_{-T}^T dt' \Delta_{11}(t, t') J_1(t') \right. \\ \left. + \frac{1}{2} \left[V(x_\eta(t)) - \left(\frac{dV}{dx} \right)_{x_\eta(t)} x_\eta(t) \right] \int_{-T}^T dt' \Delta_{21}(t, t') J_1(t') \right\}$$

The generating functional of the correlations (at any order) is

$$Z[J_1] = \exp \{ S[J_1] \} \quad (40)$$

and we can calculate any quantity by simply performing functional derivatives and finally taking $J_1 = 0$.

Instead of that and in order to validate our procedure, we will calculate the probability for the process: a particle in the initial position $x = -\sqrt{a/b}$ at time $-T$ can be found at the final position $x = x_c$ at the time $t = t_c$. (Later we will particularize to $x_c = -\sqrt{a/b}$ and $t_c = T$). The calculation of this probability P can be done in the functional approach in the following way.

We have defined the statistical ensemble of possible particle trajectories starting at $x = -\sqrt{a/b}$ at $t = -T$ and reaching an arbitrary point x at time t . In the Martin-Siggia-Rose-Jensen approach it is derived the generating functional as a functional integration over this statistical ensemble of a weight measure expressed as the exponential of the classical action. Now we restrict the statistical ensemble by imposing that the particle is found at time $t = t_c$ in the point $x = x_c$. By integration this will give us precisely the probability required.

The condition can be introduced in the functional integration by a Dirac δ function which modifies the functional measure

$$D[x(\tau)] \rightarrow D[x(\tau)] \delta[x(t_c) - x_c]$$

and we use the Fourier transform of the δ function

$$\begin{aligned} P\left(x_c, t_c; -\sqrt{\frac{a}{b}}, -T\right) &= \int D[x(\tau)] \delta[x(t_c) - x_c] \exp(S) \\ &= \frac{1}{2\pi} \int d\lambda \exp(-i\lambda x_c) \int D[x(\tau)] \exp[S + i\lambda x(t_c)] \end{aligned}$$

It is convenient to write

$$\begin{aligned} S + i\lambda x(t_c) &= i \int_{-T}^T d\tau L[x(t), k(t)] + i \int_{-T}^T d\tau \lambda x(\tau) \delta(\tau - t_c) \\ &= i \int_{-T}^T d\tau [L + \lambda x(\tau) \delta(\tau - t_c)] \end{aligned}$$

We can see that the new term plays the same rôle as the external current $J_1(\tau)$ and this suggests to return to the Eq.(40) and to perform the modification

$$J_1(\tau) \rightarrow J_1'(\tau) = J_1(\tau) + \lambda \delta(\tau - t_c)$$

obtaining

$$P\left(x_c, t_c; -\sqrt{\frac{a}{b}}, -T\right) = \frac{1}{2\pi} \int d\lambda \exp(-i\lambda x_c) Z^{(\lambda)}[J_1] \Big|_{J_1=0}$$

Using the previous results we have

$$\begin{aligned} Z^{(\lambda)}[J_1] \Big|_{J_1=0} &= \exp \left\{ i \frac{1}{2} \lambda x_\eta(t_c) \right. \\ &\quad + i \frac{1}{2} \lambda^2 \Delta_{11}(t_c, t_c) \\ &\quad \left. + i \frac{1}{2} \left[V - \left(\frac{dV}{dx} \right) x \right]_{t=t_c} \lambda \Delta_{21}(t_c, t_c) \right\} \Big|_{J_1=0} \end{aligned} \quad (41)$$

This expression will have to be calculated at $t_c = T$ and $x_c = -\sqrt{a/b}$.

$$\begin{aligned} V\left(-\sqrt{\frac{a}{b}}\right) &= 0 \\ \frac{dV}{dx} \Big|_{x=-\sqrt{\frac{a}{b}}} &= 0 \end{aligned}$$

so the last term is zero.

$$Z^{(\lambda)}[J_1] \Big|_{J_1=0} = \exp \left[-i \frac{1}{2} \lambda \sqrt{\frac{a}{b}} + i \frac{1}{2} \lambda^2 \Delta_{11}(T, T) \right] \Big|_{J_1=0} \quad (42)$$

We need the propagator Δ_{21} in the expression for Δ_{11} ,

$$\begin{aligned}\Delta_{21}(t', T) &= \Theta(T - t') \exp[-W(t')] \exp[W(T)] \\ W(T) &= 0\end{aligned}$$

Then the intration giving the propagator Δ_{11} is

$$\begin{aligned}& \int_{-T}^T dt' 2iD \Theta(T - t') \Theta(T - t') \exp[-W(t')] \exp[-W(t')] \\ &= 2iD \int_{-T}^T dt' \exp[-2W(t')] \\ &= 2iD \left\{ \exp[-4aT + 6at_1 - 6at_0] \int_{-T}^{t_0} dt \exp(4at) \right. \\ & \quad + \exp[-4aT + 6at_1] \int_{t_0}^{t_1} dt \exp(-2at) + \\ & \quad \left. + \exp[-4aT] \int_{t_1}^T dt \exp(4at) \right\}\end{aligned}$$

We introduce the notation

$$\begin{aligned}Y(t_0, t_1) &\equiv 1 + \\ & \quad + 3 \exp[-4a(T - t_1)] \{ \exp[2a(t_1 - t_0)] - 1 \} \\ & \quad - \exp[-8aT] \exp[6a(t_1 - t_0)]\end{aligned}$$

and we obtain the expression

$$\Delta_{11}(T, T) = \frac{iD}{2a} Y(t_0, t_1)$$

Returning to (42)

$$Z^{(\lambda)}[J_1 = 0] = \exp \left[-i \frac{\lambda}{2} \sqrt{\frac{a}{b}} - \frac{\lambda^2 D}{4a} Y \right]$$

and the probability is

$$\begin{aligned}P(t_0, t_1) &= \frac{1}{2\pi} \int_{-\infty}^{\infty} d\lambda \exp \left[i\lambda \sqrt{\frac{a}{b}} \right] Z^{(\lambda)}[J_1 = 0] \\ &= \frac{1}{2\pi} \int_{-\infty}^{\infty} d\lambda \exp \left[\frac{1}{2} i\lambda \sqrt{\frac{a}{b}} - \frac{\lambda^2 D}{4a} Y(t_0, t_1) \right]\end{aligned}$$

We have made manifest the dependence of the probability on the arbitrary times of jump t_0, t_1 . Integrating on λ

$$P(t_0, t_1) = \sqrt{\frac{a}{\pi DY}} \exp\left(-\frac{a^2}{4bDY}\right)$$

This expression contains an arbitrary parameter, which is the duration of stay in the intermediate position, *i.e.* at the unstable extremum of the potential, $x = 0$. Integrating over this duration, $t_0 - t_1$, adimensionalized with the unit $1/a$, for all possible values between 0 and all the time interval, $2T$, will give the probability. In doing this time integration we will make a simplification to consider that T is a large quantity, such that the exponential terms in Y will vanish. Then Y reduces to 1 and the integration is trivial

$$\begin{aligned} P &= \int_0^{2T} d[a(t_1 - t_0)] P(t_0, t_1) \\ &= 2Ta \sqrt{\frac{a}{\pi D}} \exp\left(-\frac{a^2}{4bD}\right) \end{aligned}$$

This is our answer. To compare with the result of Caroli et al., we first adopt their notation $T \equiv t/2$ and we write the potential as

$$V(x) = -U'(x)$$

with

$$U(x) = -\frac{1}{2}ax^2 + \frac{1}{4}bx^4$$

We note that

$$U(x=0) - U\left(-\sqrt{\frac{a}{b}}\right) = 0 + \frac{a^2}{4b}$$

which allows to write

$$P = t \frac{a^{3/2}}{\sqrt{\pi D}} \exp\left[-\frac{U(0) - U\left(-\sqrt{\frac{a}{b}}\right)}{D}\right]$$

which corresponds to the result of Caroli et al. for a single instanton-anti-instanton pair, where

$$a^{3/2} \sim |U_0''|^{1/2} U''_{-\sqrt{a/b}}$$

The only problem is the need to consider the reverse of sign due to the virtual reflection at the position $x = 0$. In the treatment of Caroli, it is included by an integration in complex time plane, after the second jump, t_1 .

4.4 The trajectory reflection and the integration along the contour in the complex time plane

The problem arises at the examination of the Eq.(32) where it is noticed that the constant C multiplying the exponential term *in the exponential* in the integrations over t_0 and t_1 is positive (see Eq.(33)). Then the dependence of the integrand on $t_1 - t_0$ makes that the most important contribution to the integration over the variable t_1 to come from

$$t_1 - t_0 \ll \frac{1}{(2W_0'')^{1/2}} = \omega_0^{-1} \sim \Delta t$$

Here the integrand is of the order

$$\sim \exp\left(\frac{C}{D}\right)$$

This would imply, in physical terms, that the most important configurations contributing to the path integral would be pairs of instanton anti-instanton very closely separated, *i.e.* transitions with very short time of stay in the point 0. This is not correct since we expect that in large time regime the trajectories assembled from instantons and anti-instantons with arbitrary large separations (duration of residence in 0 before returning to b) should contribute to K .

This problem can be solved by extending the integration over the variable representing the time separation between the transitions

$$z = t_1 - t_0$$

in complex.

NOTE. The quantity

$$(2W_0'')^{1/2} = \omega_0$$

is the frequency of the harmonic oscillations in the parabolic approximation of the potential.

The contour C is defined as

$$\begin{aligned} \text{Im } z &= \frac{\pi}{|U_0''|} \\ 0 &\leq \text{Re } z \leq \frac{t}{2} - t_0 \end{aligned}$$

The form of the trajectory x_{IA} connecting the point b to itself, b , assembled from one instanton x_I and one anti-instanton x_A can now be described as follows.

The trajectory starts in the point b and follows the usual form of the instanton solution, which means that for times

$$-\frac{t}{2} < \tau \lesssim t_0$$

it practically coincides with the fixed position b . At t_0 it makes the transition to the point 0, the duration of the transition (width of the instanton) being Δt . Then it remains almost fixed at the point 0. The problem is that there is *no* turning point at $x = 0$ since there the potential $-W(x)$ is smaller than at $x = b$. Then we do not have the classical instanton which takes an infinite time to reach exactly $x = 0$, etc. Also there is no exact instanton solution which starts from $x = 0$ to go back to $x = b$. In the assembled solution $x_I + x_A$, there is a discontinuity at $x = 0$ in the derivative, the velocity simply is forced (assumed) to change from almost zero positive (directed toward $x = 0$) to almost zero negative (directed toward $x = b$). What we do is to introduce a turning point, which limits effectively the transition solution, but for this we have to go to complex time, to compensate for the negative value of the potential. Making time imaginary changes the sign of the velocity squared (kinetic energy) and correspondingly can be seen as a change of sign of the potential which now becomes positive and presents a wall from where the solution can reflect. This is actually a local Euclideanization of the theory, around the point $x = 0$.

At time $(t_0 + t_1)/2$ the trajectory starts moving along the imaginary z axis. It reaches an imaginary turning point at $\frac{i\pi}{|U_0''|}$ and returns to the point $\text{Re } z = x_{IA} \left(\frac{t_0+t_1}{2}\right)$, $\text{Im } z = 0$.

This trajectory can be considered the limiting form of the trajectory of a fictitious particle that traverses a part of potential (forbidden classically) when this part goes to zero.

Then the expression is

$$K^{(1)} \left(b, \frac{t}{2}; b, -\frac{t}{2} \right) = -t \left(\frac{|U_0''|}{2\pi D} \right)^{1/2} \frac{(U_b'' |U_0''|)^{1/2}}{2\pi} \exp \left(-\frac{U_0 - U_b}{D} \right)$$

where the minus sign is due to the reflection at the turning point.

4.5 Summation of terms from multiple transitions

Calculation of the transitions implying the points b and a

This is the term

$$K_{ba}^{(2)} \left(b, -\frac{t}{2}; a, \frac{t}{2} \right)$$

and corresponds to the transitions

$$b \rightarrow 0 \rightarrow a \rightarrow 0 \rightarrow b$$

Again we have to introduce a new potential replacing W . The real potential $W(x)$ as it results from the Langevin equation, depends on D which is supposed to be small. Then the “expansion” in this small parameter D has as zeroth order the new potential $W^{(0)}(x)$ that will be used in the computations below. This is

$$W^{(0)} = W - \delta W$$

$$\delta W(x) = \begin{cases} 0 & x < x_m \\ W_0 - W_b & x_m < x < x_p \\ W_a - W_b & x > x_p \end{cases}$$

where the new point x_p is in the region of the right-hand minimum of $-W(x)$. This point will correspond to the center of the instanton connecting 0 to a .

We introduce the new family of instanton solution

$$\tilde{x}_I(\tau - t_1)$$

in the potential $-W^{(0)}$ that leave $x = 0$ at $-\infty$ and reach $x = a$ at time ∞ .

With this instanton and the previously defined ones, we assemble a function that provides approximately the transitions connecting b to b via a . This, obviously, is not a classical solution of the equation of motion, although it is very close to a solution.

$$x_{IIAA}(\tau; t_0, t_1, t_2, t_3) = \begin{cases} x_I(\tau - t_0) & \tau < \frac{1}{2}(t_0 + t_1) \\ \tilde{x}_I(\tau - t_1) & \frac{1}{2}(t_0 + t_1) < \tau < \frac{1}{2}(t_1 + t_2) \\ \tilde{x}_I(t_2 - \tau) & \frac{1}{2}(t_1 + t_2) < \tau < \frac{1}{2}(t_2 + t_3) \\ x_I(t_3 - \tau) & \tau > \frac{t_2 + t_3}{2} \end{cases}$$

These trajectories are rather artificial, being assembled from pieces of true solutions. They have singularities: in the middle, at $(t_1 + t_2)/2$ the function is continuous but the derivative is discontinuous; in the points where one instanton arrives and another must continue (*i.e.* $(t_0 + t_1)/2$ and $(t_2 + t_3)/2$, both the function and the derivatives are discontinuous.

This is corrected by extending the trajectories in the complex time plane. One defines the variables

$$\begin{aligned} z_1 &= t_1 - t_0 \\ z_2 &= t_2 - t_1 \\ z_3 &= t_3 - t_2 \end{aligned}$$

and the three integration contours

$$\begin{aligned} C_1 \quad \text{Im } z_1 &= \frac{\pi}{|U_0''|} & 0 \leq \text{Re } z_1 \leq \frac{t}{2} - t_0 \\ C_2 \quad \text{Im } z_2 &= \frac{\pi}{U_a''} & 0 \leq \text{Re } z_2 \leq \text{Re} \left(\frac{t}{2} - t_1 \right) \\ C_3 \quad \text{Im } z_3 &= \frac{\pi}{|U_0''|} & 0 \leq \text{Re } z_3 \leq \frac{t}{2} - t_2 \end{aligned}$$

Together these contours must assure the continuity of the function x_{IA} in the region 0, from which the condition arises

$$x_I \left[\text{Re} \left(\frac{t_1 - t_0}{2} \right) \right] = -\tilde{x}_I \left[\text{Re} \left(\frac{t_0 - t_1}{2} \right) \right]$$

which gives for large separations $t_1 - t_0$

$$x_p \exp(|U_0''| \Delta_{0p}) = |x_m| \exp(|U_0''| \Delta_{m0})$$

The expression of K at this moment is

$$\begin{aligned} K_{ba}^{(2)} \left(b, \frac{t}{2}; b, -\frac{t}{2} \right) &= \left(\frac{2\pi D}{U_a''} \right)^{1/2} \frac{U_b'' U_a'' U_0''^2}{4} x_m^2 x_p^2 \left(\frac{|U_0''|}{2\pi D} \right)^3 \\ &\times \exp \left[-\frac{2U_0 - U_a - U_b}{D} + 2|U_0''| (\Delta_{m0} + \Delta_{0p}) \right] \\ &\times \int_{-t/2}^{t/2} dt_0 \int_{C_1} dz_1 \int_{C_2} dz_2 \int_{C_3} dz_3 \exp [F(z_1) + G(z_2) + F(z_3)] \end{aligned}$$

where

$$F(z) = \frac{C_0}{D} \exp(-|U_0''| z) - |U_0''| \text{Re } z \quad (43)$$

$$G(z) = \frac{C_a}{D} \exp(-U_a'' z) \quad (44)$$

and

$$C_0 = \frac{x_m^2 |U_0''|}{2} \exp(2|U_0''| \Delta_{m0}) \quad (45)$$

$$C_a = \frac{(a - x_p)^2 U_a''}{2} \exp(2U_a'' \Delta_{pa}) \quad (46)$$

It is necessary to carry out the complex time integrals.

The z_3 integral. Here we have

$$\int_{C_3} dz_3 \exp \left\{ \frac{C_0}{D} \exp(-|U_0''|z) - |U_0''| \operatorname{Re} z \right\}$$

along the real axis of z , we can substitute

$$u = \exp(-|U_0''|z)$$

and obtain

$$\int_{\operatorname{Re} C_3} \frac{-1}{|U_0''|} du \exp\left(-\frac{C_0}{D}u\right) = -\frac{D}{|U_0''|C_0} \int dw \exp(-w)$$

This simply results in the constant

$$\frac{D}{C_0|U_0''|} \tag{47}$$

The z_2 integral; The z_2 integral involves only the exponential of $G(z_2)$ and the latter function does not contain a term proportional with $\operatorname{Re} z_2$ (compare with (43)), but only the exponential term. The function $G(z_2)$ is very close to 1 as soon as

$$\operatorname{Re} z_2 \gg t_S^{(a)} \simeq \frac{1}{U_a''} \ln\left(\frac{C_a}{D}\right)$$

where $t_S^{(a)}$ is the Suzuki time for the region a

$$t_S^{(a)} \ll t \sim \tau_K$$

Then, with very good approximation

$$\int_{C_2} dz_2 \exp[G(z_2)] = \int_0^{\frac{t}{2}-t_1} dz_2 \exp[G(z_2)] \simeq \frac{t}{2}$$

The z_1 integral. This is similar to the integral over z_3 and will imply again $\frac{D}{C_0|U_0''|}$ as in (47).

Finally we note that only the constant C_0 relative to the intermediate point 0 appears, and the one for the farthest point of the trajectory, a , is absent.

There will be then a time integration over the moment of the first transition, t_0 , of an integrand that contains the time t arising from the integration on the contour C_2 , in the complex plane of the variable $z_2 = t_2 - t_1$. This

variable represents the duration between the last transition to a and the first transition from a , *i.e.* is the duration of stay in a . This time integration will produce a term with t^2 .

Replacing in the expressions resulting from the integrations on z_1 and z_3 the constant C_0 from (45) the factors x_m and x_p disappear.

The result is

$$K_{ba}^{(2)} \left(b, \frac{t}{2}; b, -\frac{t}{2} \right) = \frac{t^2}{2!} \left(\frac{|U_b''|}{2\pi D} \right)^{1/2} \frac{(|U_0''| U_a'')^{1/2}}{2\pi} \frac{(|U_0''| U_b'')^{1/2}}{2\pi} \\ \times \exp \left(-\frac{2U_0 - U_a - U_b}{D} \right)$$

5 The probability

The objective is to calculate $P \left(b, \frac{t}{2}; b, -\frac{t}{2} \right)$ on the basis of the above results. We have to sum over any number of independent pseudomolecules of the four species

$$\begin{aligned} (b0b) &\longleftrightarrow -\alpha_b \\ (b0a) &\longleftrightarrow \alpha_b \\ (a0b) &\longleftrightarrow \alpha_a \\ (b0b) &\longleftrightarrow -\alpha_a \end{aligned}$$

where the factor which is associated to each pseudomolecule is

$$\alpha_i = \frac{(|U_0''| U_i'')^{1/2}}{2\pi} \exp \left(-\frac{U_0 - U_i}{D} \right), \quad i = a, b$$

A particular path containing n $(b0b)$ and m $(a0a)$ has the form

$$(-1)^{n+m} \frac{t^{n+m+2p}}{(n+m+2p)!} \alpha_b^{n+p} \alpha_a^{p+m} \left(\frac{|U_b''|}{2\pi D} \right)^{1/2}$$

It was taken into account that a path $(b \rightarrow b)$ contains the same number p of $(b0a)$ and of $(a0b)$.

5.0.1 Transition and self-transition probabilities at the equilibrium points

The results from the previous calculations are listed below.

The probability that a particle initially at $(b, -\frac{t}{2})$ will be found at $(b, \frac{t}{2})$

$$P \left(b, \frac{t}{2}; b, -\frac{t}{2} \right) = \left(\frac{|U_b''|}{2\pi D} \right)^{1/2} \frac{1}{\alpha_a + \alpha_b} \{ \alpha_a + \alpha_b \exp [-t(\alpha_a + \alpha_b)] \}$$

The probability that a particle initially at $(b, -\frac{t}{2})$ will be found at $(a, \frac{t}{2})$

$$P\left(a, \frac{t}{2}; b, -\frac{t}{2}\right) = \left(\frac{U_a''}{2\pi D}\right)^{1/2} \frac{\alpha_b}{\alpha_a + \alpha_b} \{1 - \exp[-t(\alpha_a + \alpha_b)]\}$$

The probability that a particle initially at $(a, -\frac{t}{2})$ will be found at $(b, \frac{t}{2})$

$$P\left(b, \frac{t}{2}; a, -\frac{t}{2}\right) = \left(\frac{U_b''}{2\pi D}\right)^{1/2} \frac{\alpha_a}{\alpha_a + \alpha_b} \{1 - \exp[-t(\alpha_a + \alpha_b)]\}$$

The probability that a particle initially at $(a, -\frac{t}{2})$ will be found at $(a, \frac{t}{2})$

$$P\left(a, \frac{t}{2}; a, -\frac{t}{2}\right) = \left(\frac{|U_a''|}{2\pi D}\right)^{1/2} \frac{1}{\alpha_a + \alpha_b} \{\alpha_b + \alpha_a \exp[-t(\alpha_a + \alpha_b)]\}$$

5.0.2 Transitions between arbitrary points

The long time limit of the probability density

$$P\left(x, \frac{t}{2}; x_0, -\frac{t}{2}\right)$$

The formula has been derived for the case where the two positions x and x_0 belong to the harmonic regions (a) and (b). This is because asymptotically these regions will be populated.

Consider the case where

$$\begin{aligned} x_0 &\in (b) \\ x &\in (a) \end{aligned}$$

The first trajectory contributing to the path integral is the direct connection between b and a . The contribution to K is

$$K^{direct}\left(x, \frac{t}{2}; x_0, -\frac{t}{2}\right) \sim \exp\left(-\frac{S_{b0} + S_{0a}}{D}\right)$$

Since the points of start and/or arrival x_0, x are different of b, a , there is finite (*i.e.* non exponentially small) slope of the solution, and there is no degeneracy with respect to the translation of the center of the instantons. then there will be not a proportionality with time in the one-instanton term.

The terms connecting x_0 with x with only one intermediate step in either b or a have comparable contributions to the action.

Now the term with two intermediate steps

$$x_0 \rightarrow b \rightarrow a \rightarrow x$$

In the very long time regime, $K^{(1)}$ can be factorized

$$\begin{aligned} K^{(1)}\left(x, \frac{t}{2}; x_0, -\frac{t}{2}\right) &= K_{harm}\left(x, \frac{t}{2}; a, t'\right) \\ &\times \left(\frac{2\pi D}{U''_a}\right)^{1/2} K^{(1)}(a, t'; b, t'') \left(\frac{2\pi D}{U''_b}\right)^{1/2} \\ &\times K_{harm}\left(b, t''; x_0, -\frac{t}{2}\right) \end{aligned}$$

This equation is independent of t' and t'' as long as

$$t_K \gg \frac{t}{2} - t' \text{ and } t'' - \left(-\frac{t}{2}\right) \gg t_S$$

Then

$$K_{harm}\left(x, \frac{t}{2}; a, t'\right) \simeq \left(\frac{U''_a}{2\pi D}\right)^{1/2} \exp\left[-\frac{U(x) - U_a}{2D}\right]$$

There is also the approximate equality

$$K^{(1)}(a, t'; b, t'') \approx K^{(1)}\left(a, \frac{t}{2}; b, -\frac{t}{2}\right)$$

It results that all the contributions are included if in the expression of $K^{(1)}\left(x, \frac{t}{2}; x_0, -\frac{t}{2}\right)$ we replace the middle factor, which has become $K^{(1)}\left(a, \frac{t}{2}; b, -\frac{t}{2}\right)$ by the full $K\left(a, \frac{t}{2}; b, -\frac{t}{2}\right)$. It is obtained

$$\begin{aligned} P\left(x, \frac{t}{2}; x_0, -\frac{t}{2}\right) &= \exp\left[-\frac{U(x) - U_a}{2D}\right] P\left(a, \frac{t}{2}; b, -\frac{t}{2}\right) \\ &= \exp\left[-\frac{U(x) - U_a}{2D}\right] \left(\frac{U''_a}{2\pi D}\right)^{1/2} \frac{\alpha_b}{\alpha_a + \alpha_b} \{1 - \exp[-t(\alpha_a + \alpha_b)]\} \end{aligned}$$

The case where both x and x_0 belong to the harmonic region (b)

The same calculation shows that

$$P\left(x, \frac{t}{2}; x_0, -\frac{t}{2}\right) = \exp\left[-\frac{U(x) - U_b}{2D}\right] \left(\frac{U''_b}{2\pi D}\right)^{1/2} \frac{1}{\alpha_a + \alpha_b} \{\alpha_a + \alpha_b \exp[-t(\alpha_a + \alpha_b)]\}$$

6 Results

In the following we reproduce the graphs of the time-dependent probability distribution of a system governed by the basic Langevin equation. Various initialisations are considered, showing rapid redistribution of the density of presence of the system. The speed of redistribution is, naturally, connected to the asymmetry of the potential. Each figure consists of a set of graphs:

- the potential functions $V(x)$, $U(x)$ and $W(x)$
- four probabilities of passage from and between the two equilibrium points a and b ;
- the average value of the position of the system, as function of time, for the two most characteristic initializations

The two parameters a and D take different values, for illustration. (We apologize for the quality of the figures. Better but larger PS version can be downloaded from <http://florin.spineanu.free.fr/sciarchive/topicalreview.ps>)

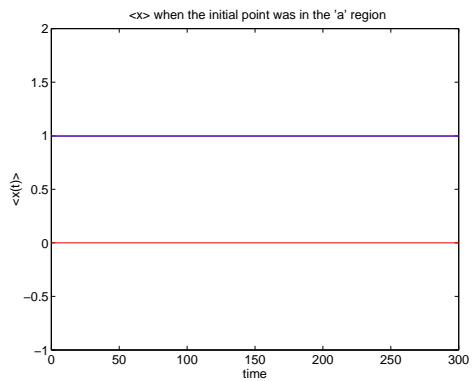
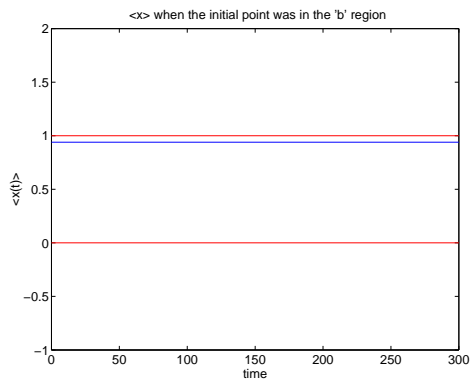
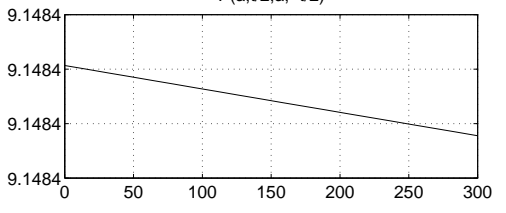
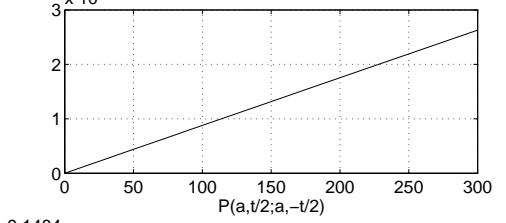
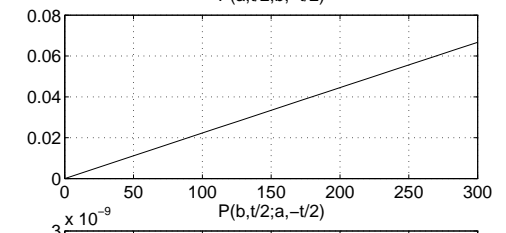
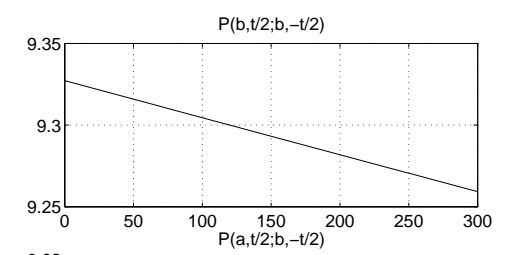
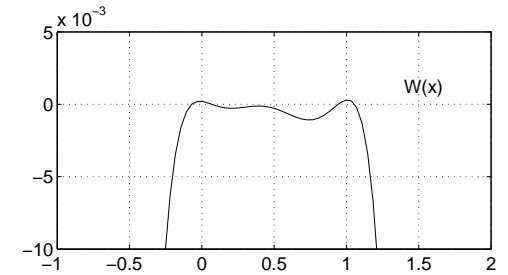
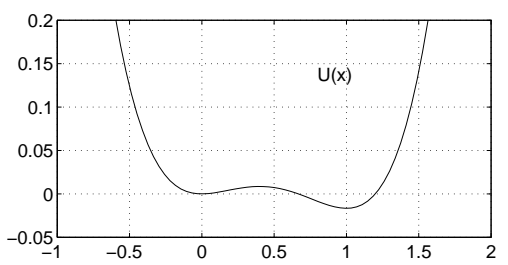
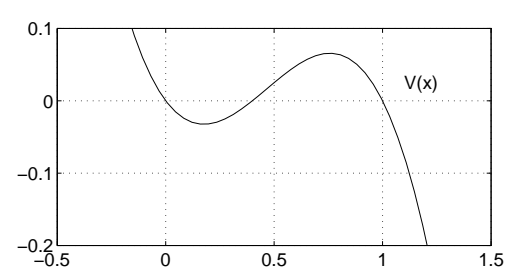

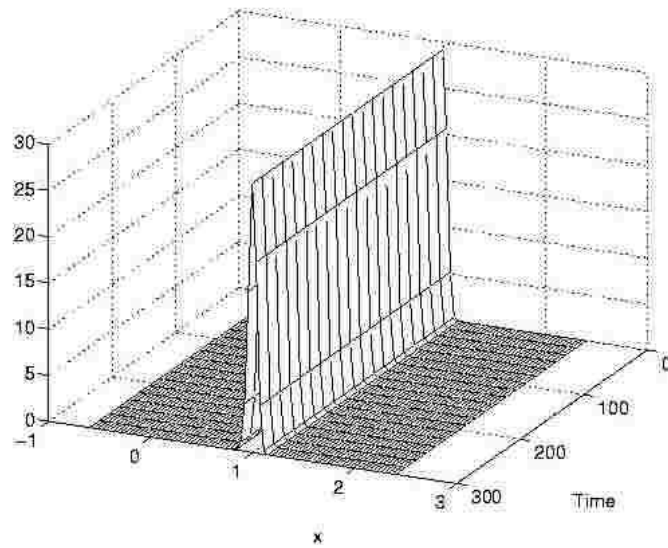
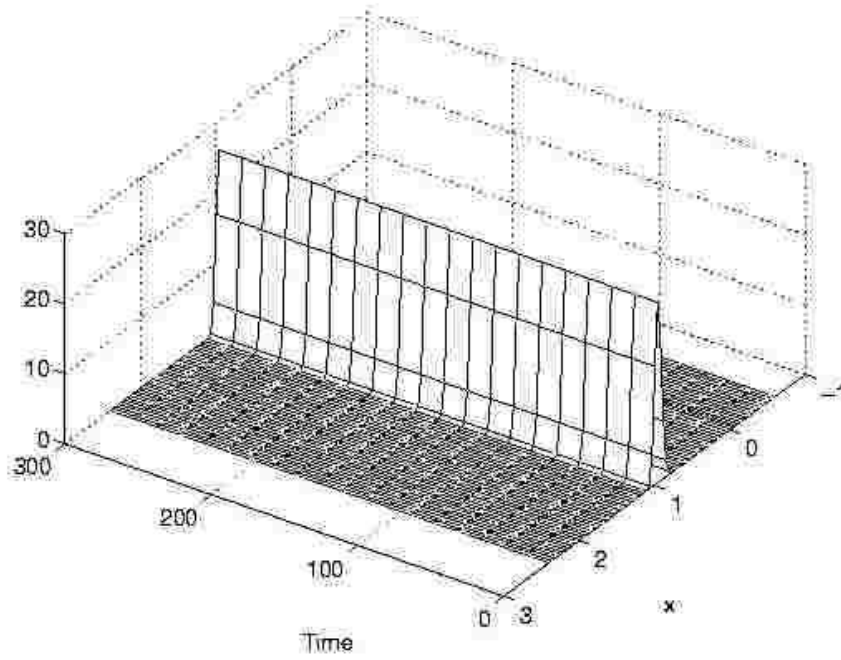
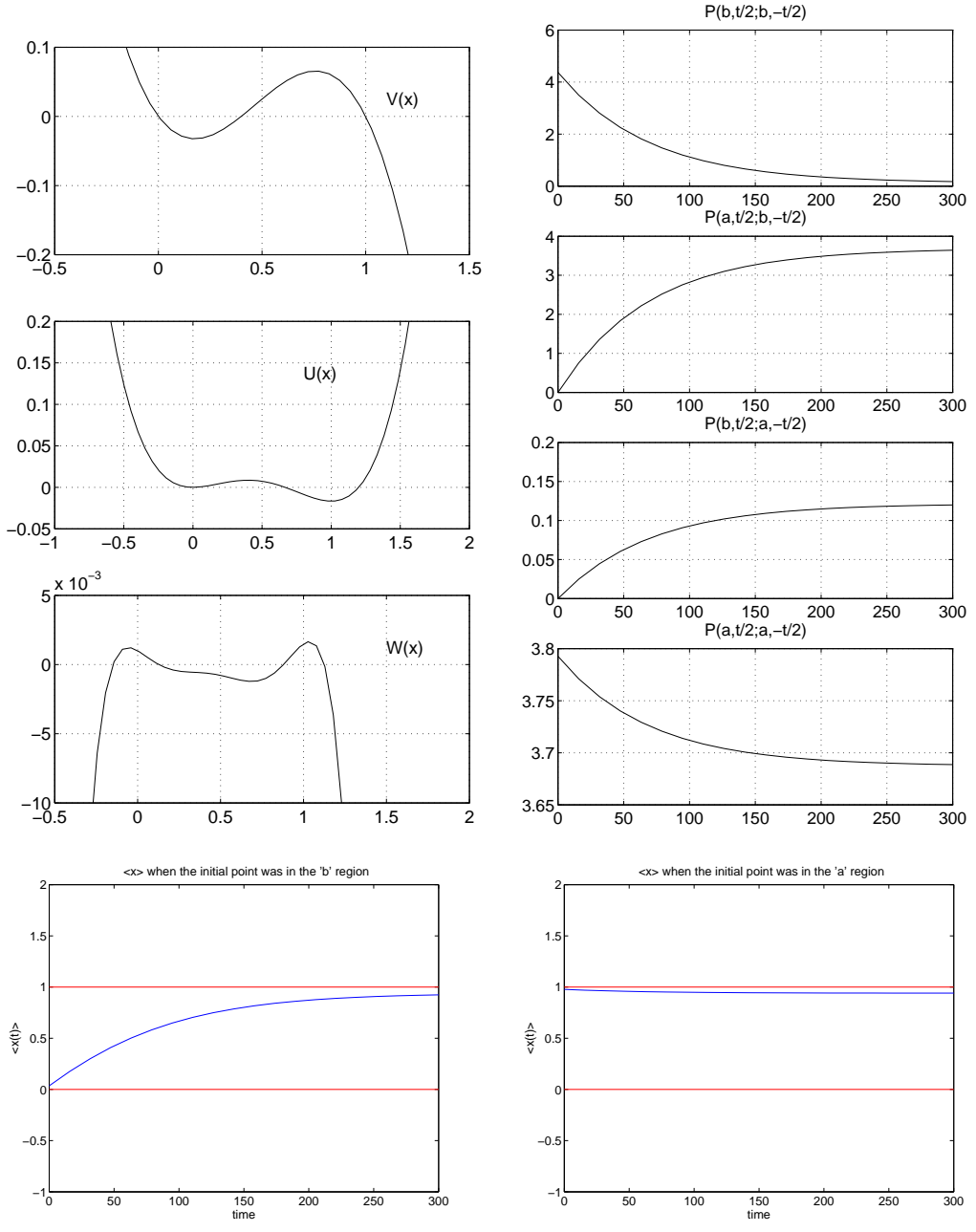

Figure 5: Parameters: $a = 0.4$ and $D = 0.001$



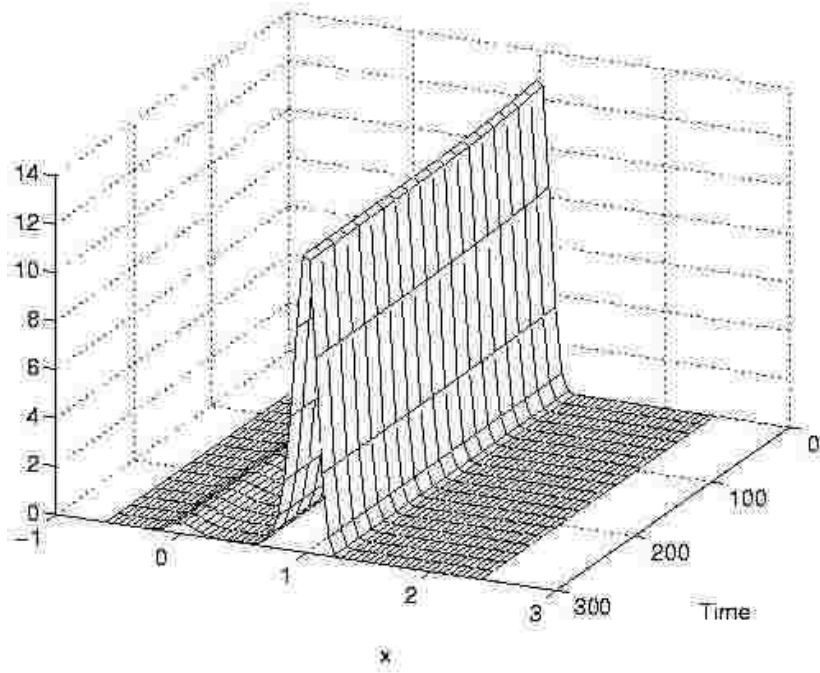
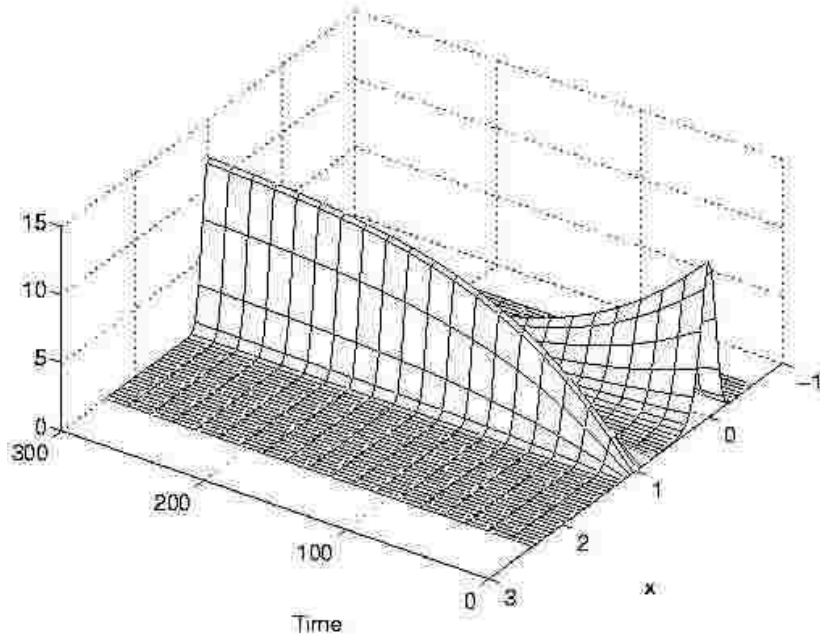
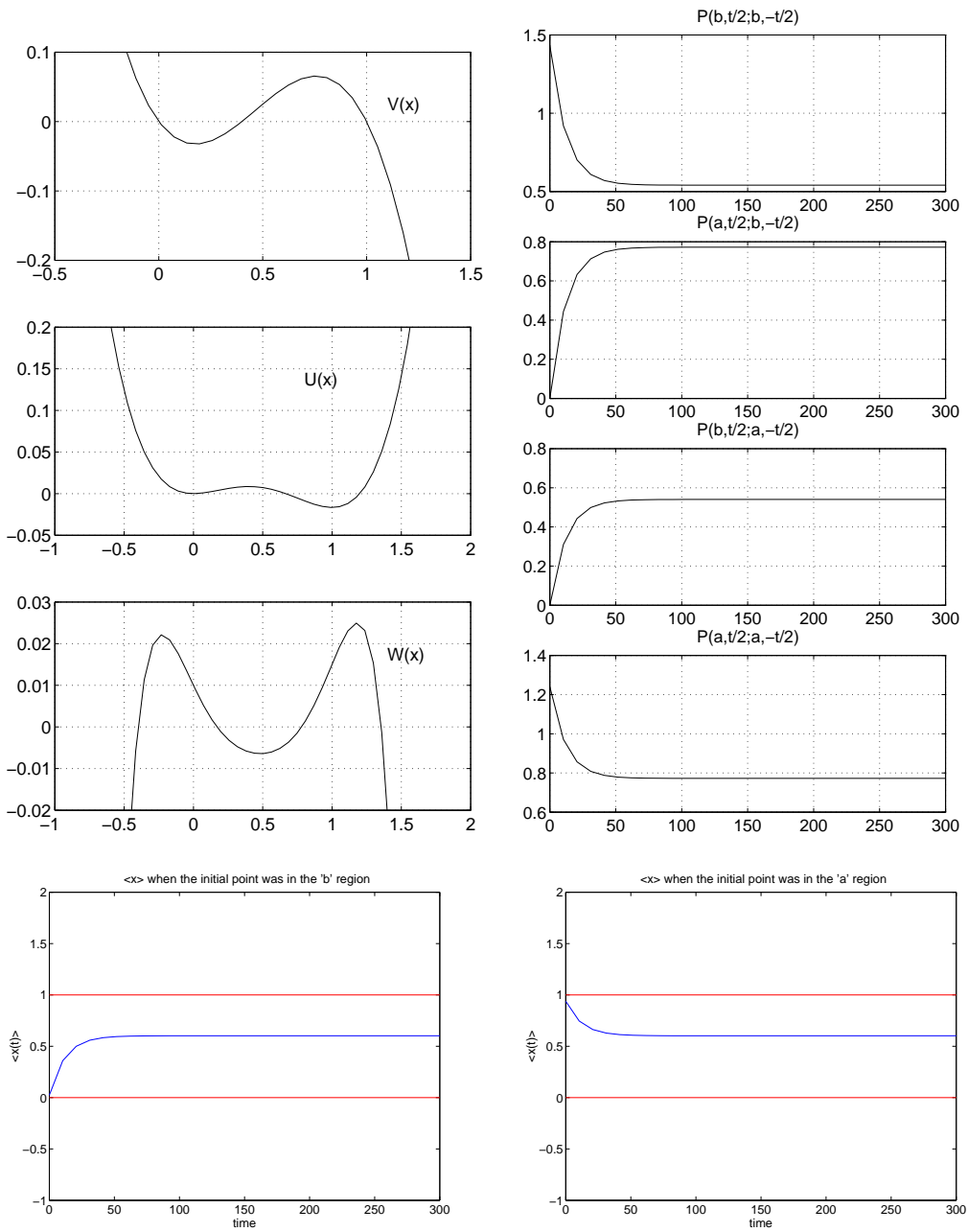

Figure 6: Parameters: $a = 0.4$ and $D = 0.005$



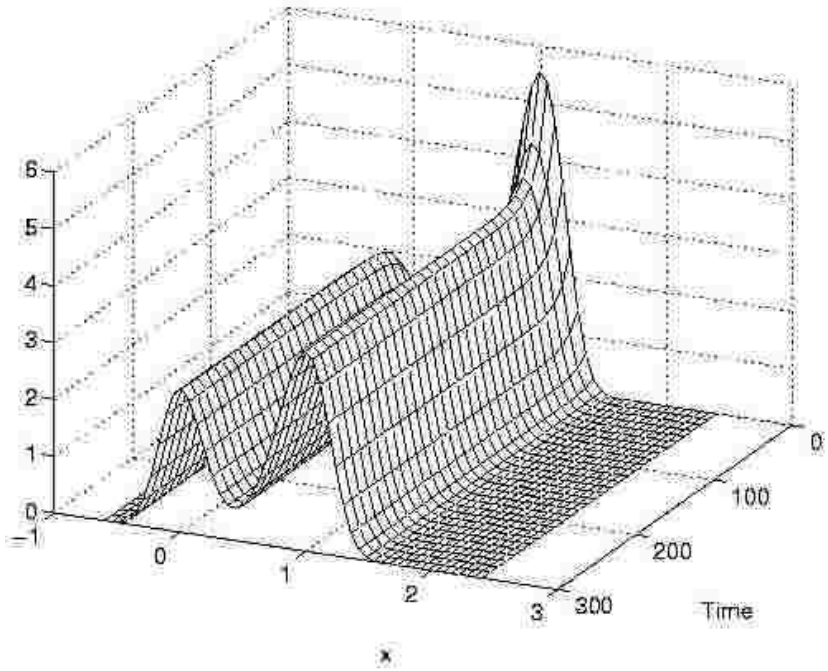
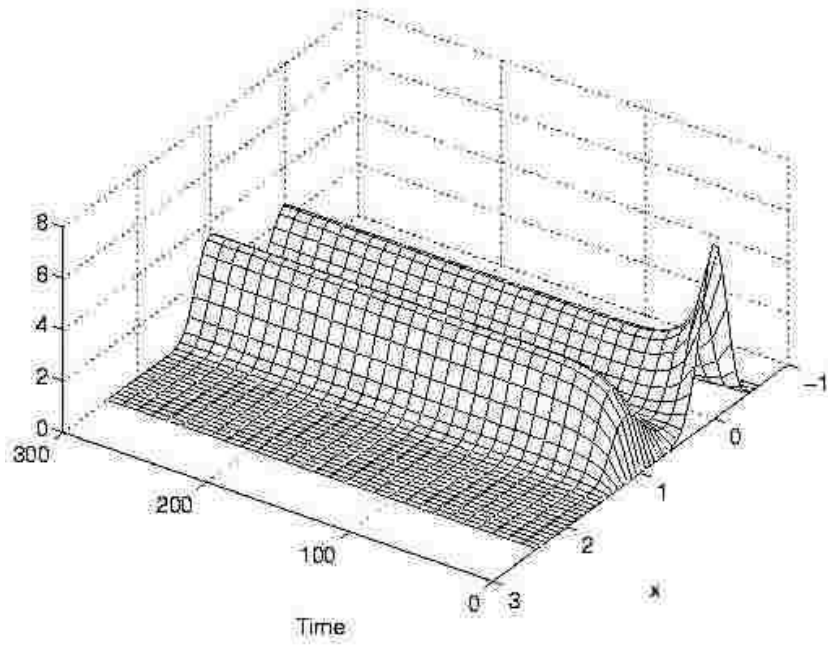
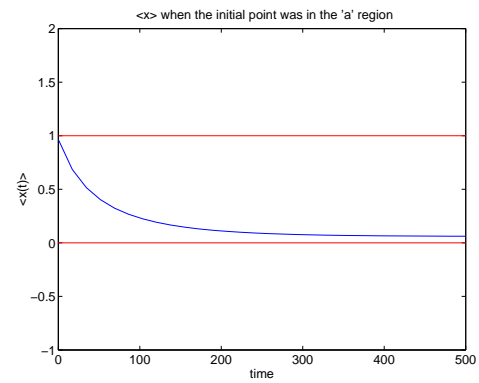
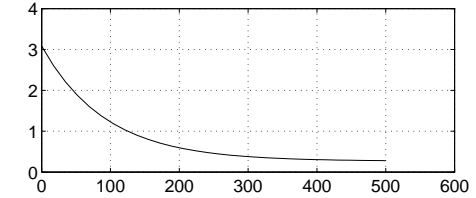
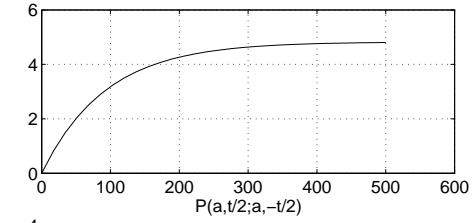
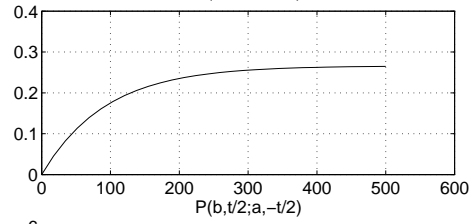
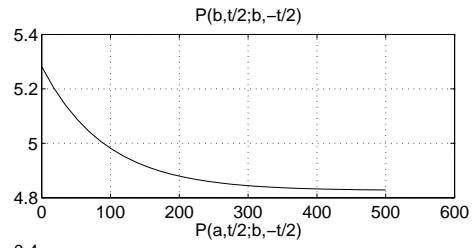
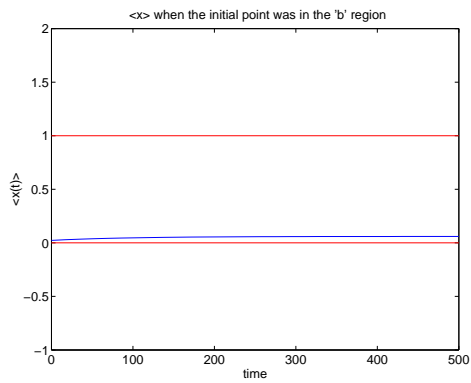
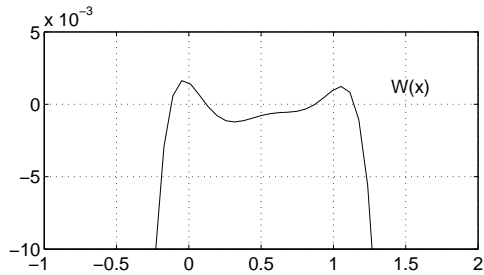
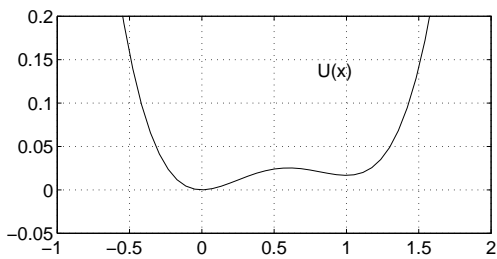
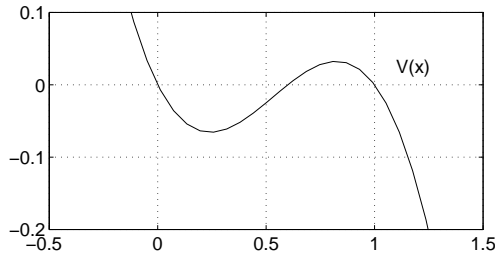

Figure 7: Parameters: $a = 0.4$ and $D = 0.05$



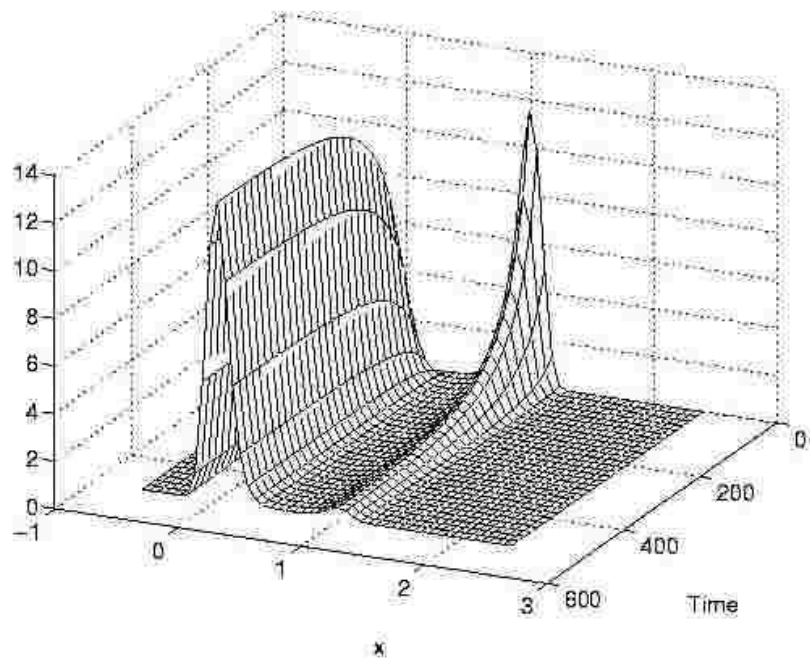
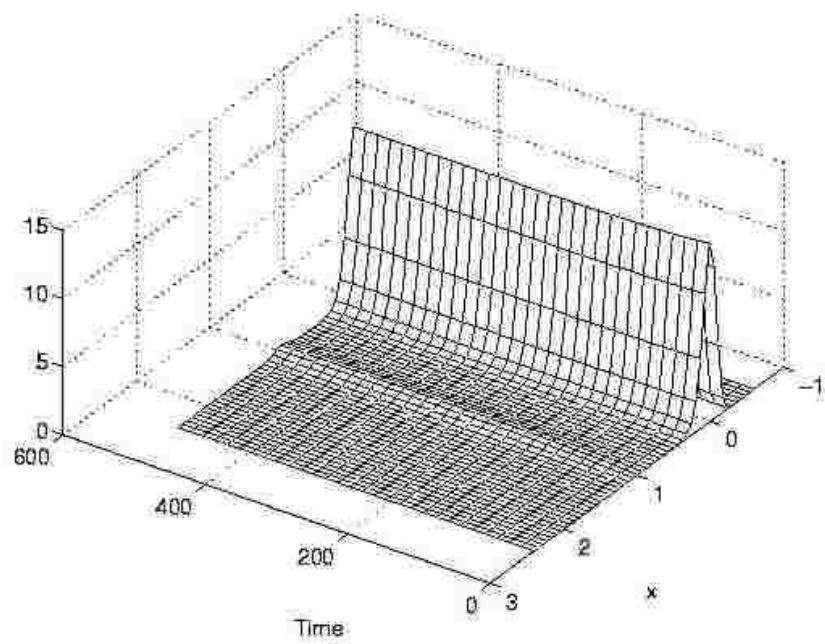
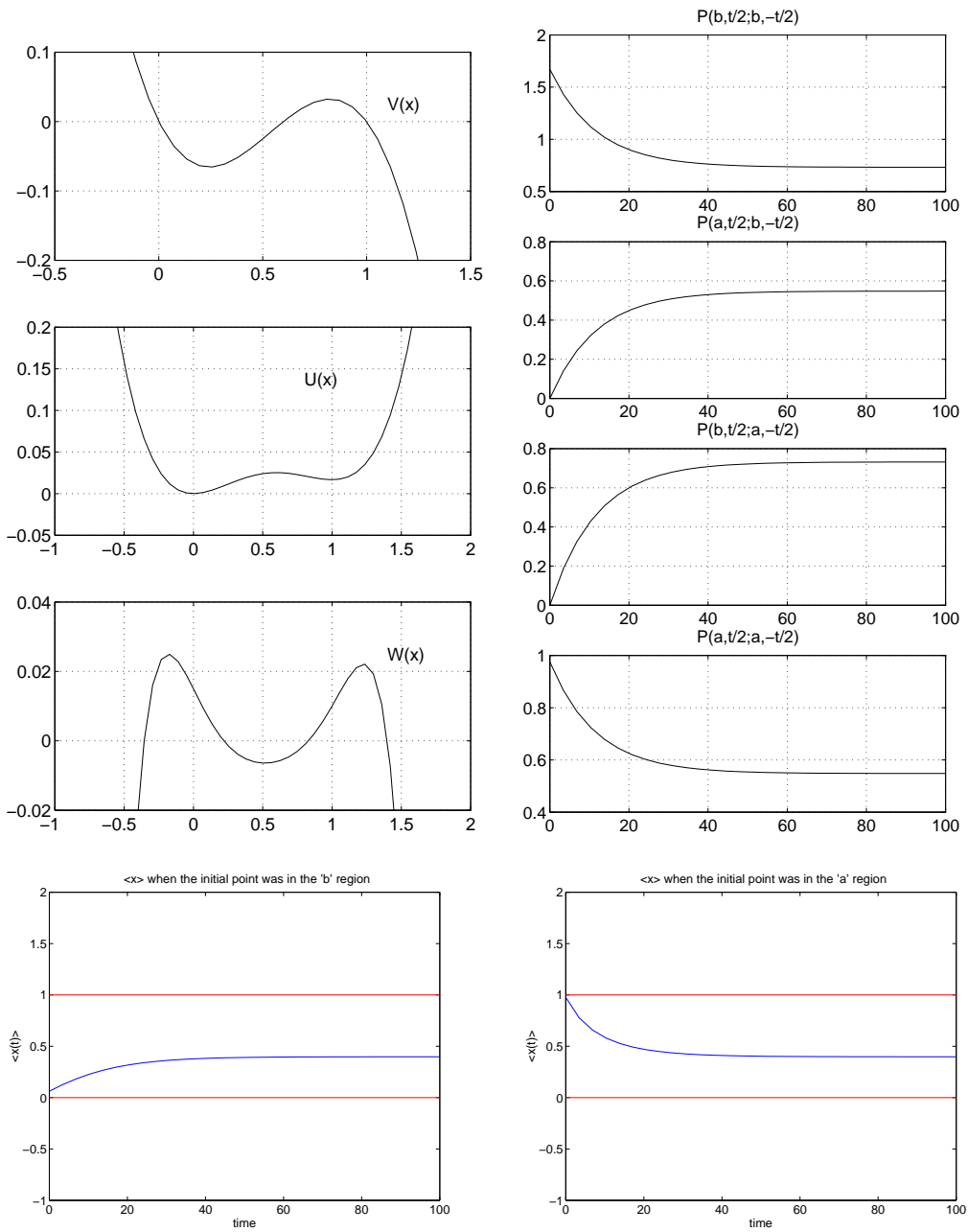

Figure 8: Parameters: $a = 0.6$ and $D = 0.005$



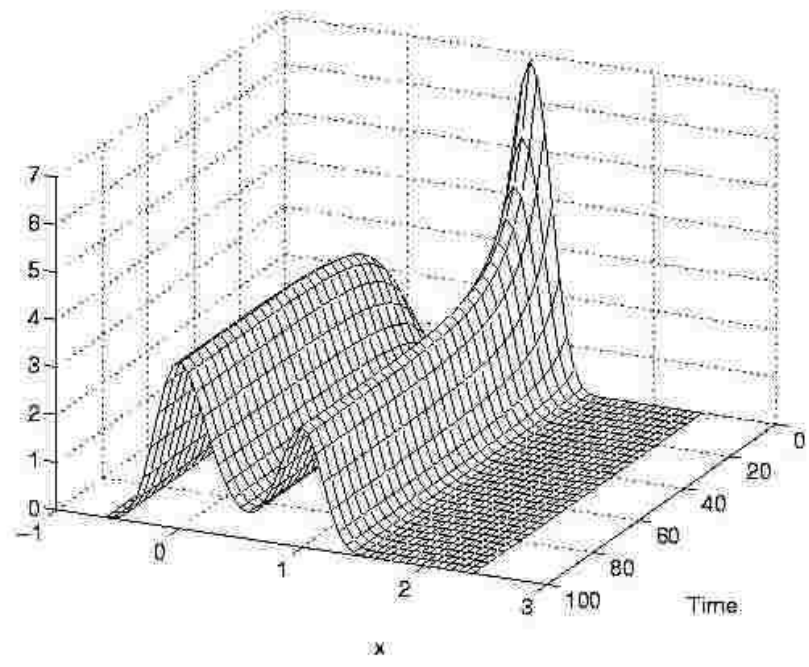
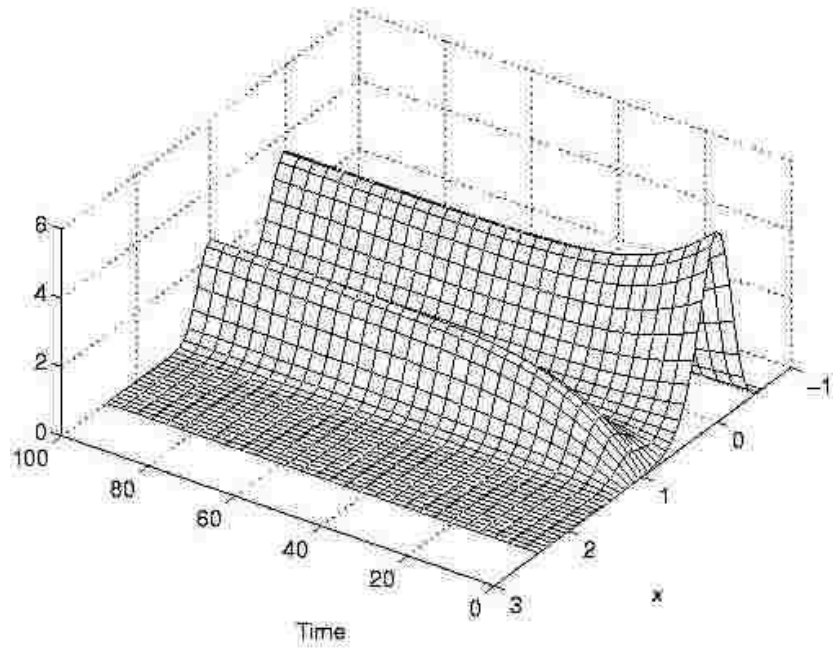
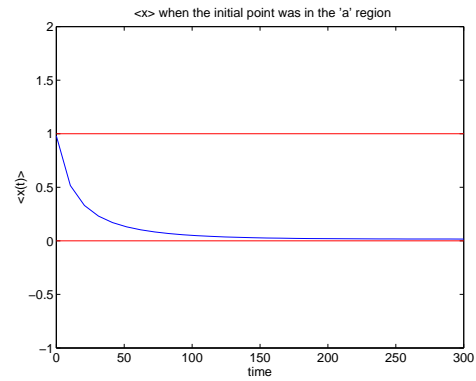
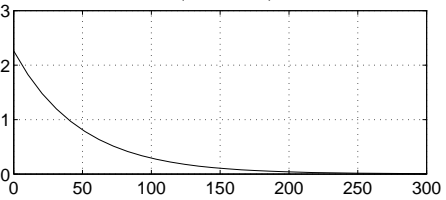
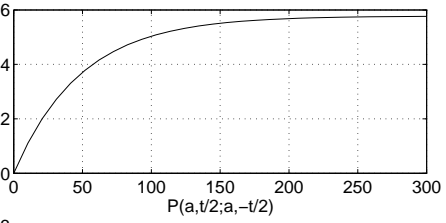
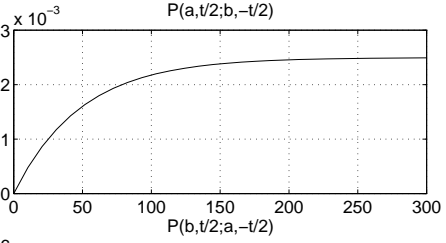
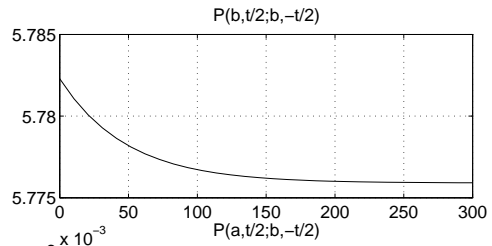
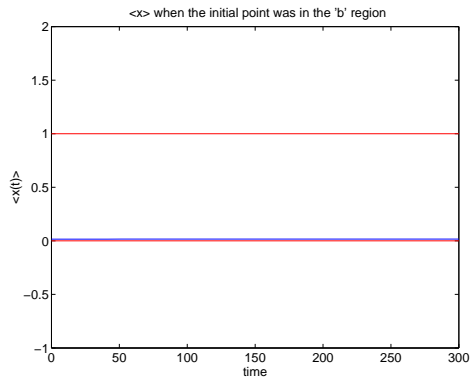
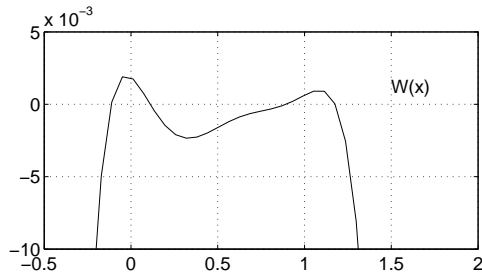
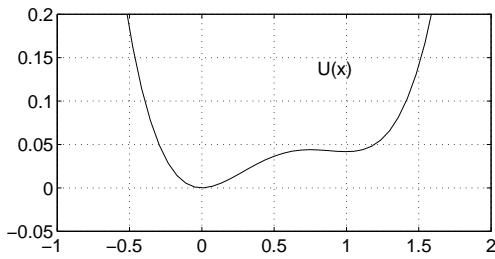
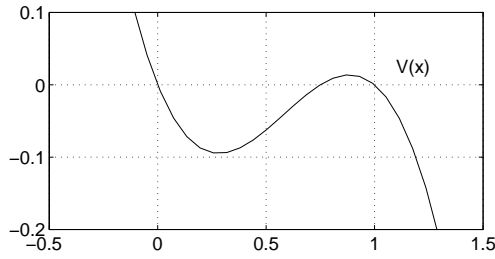

Figure 9: Parameters: $a = 0.6$ and $D = 0.05$



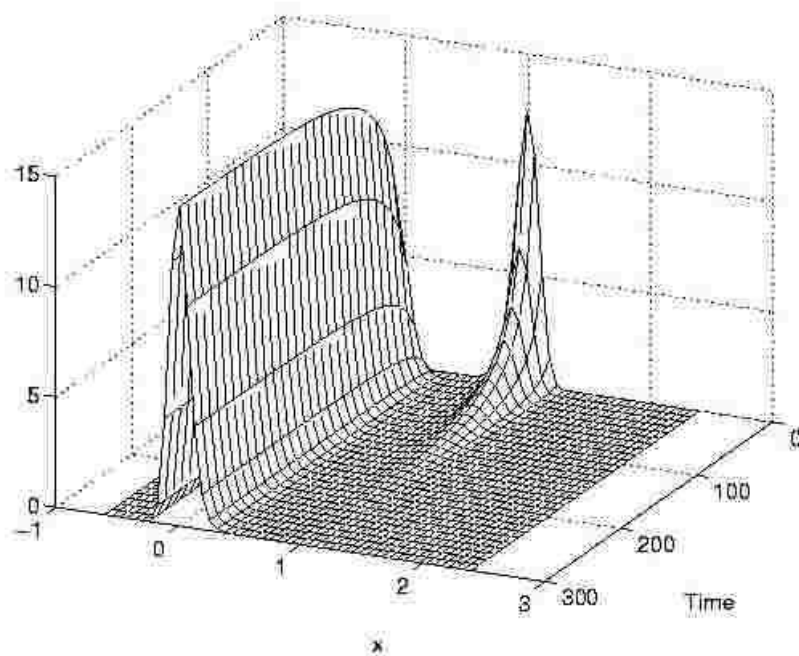
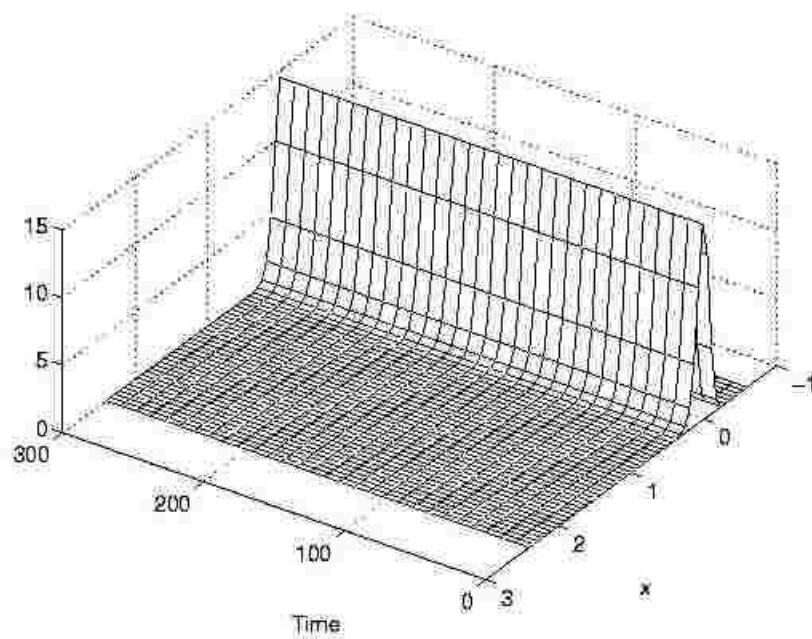
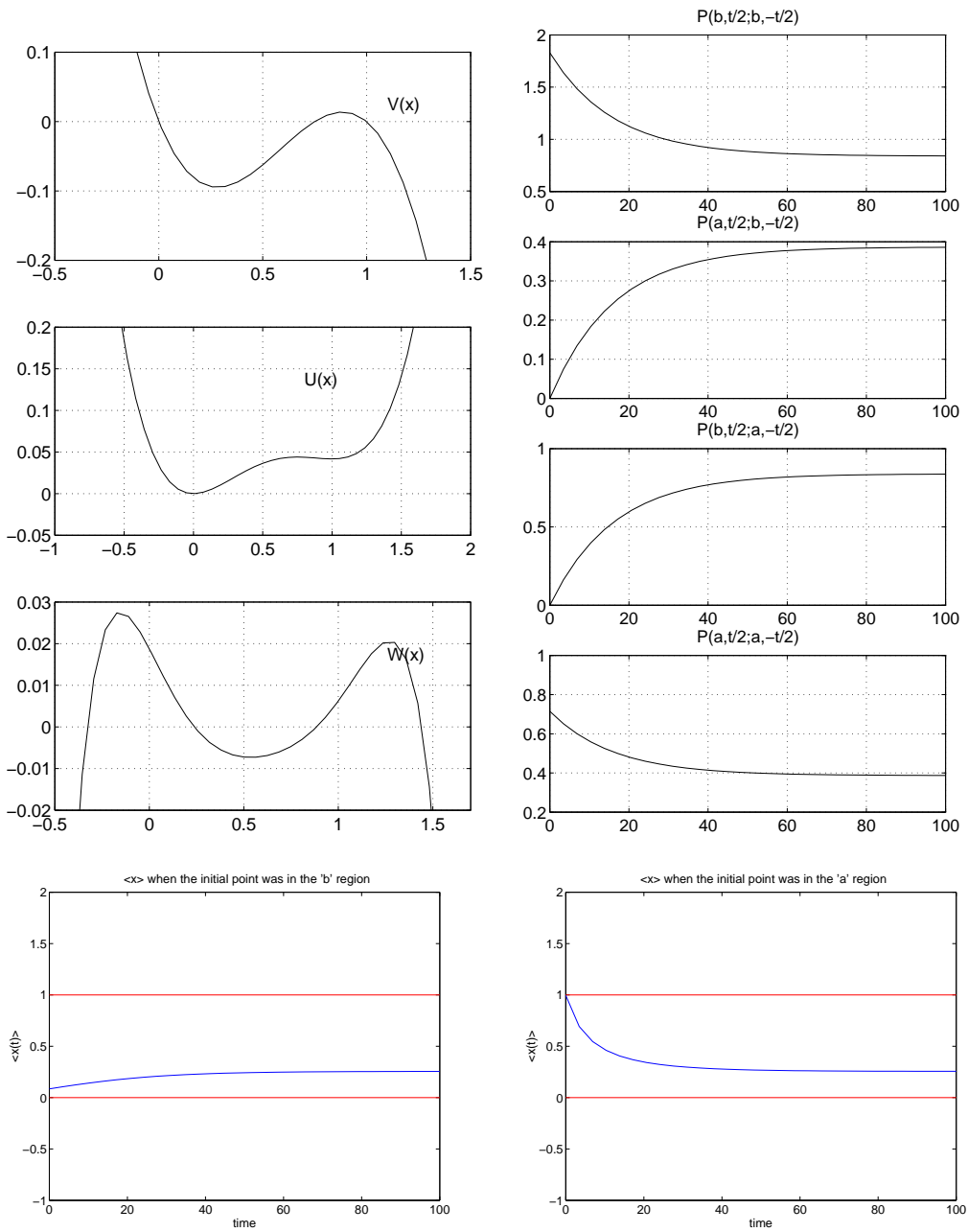

Figure 10: Parameters: $a = 0.75$ and $D = 0.005$



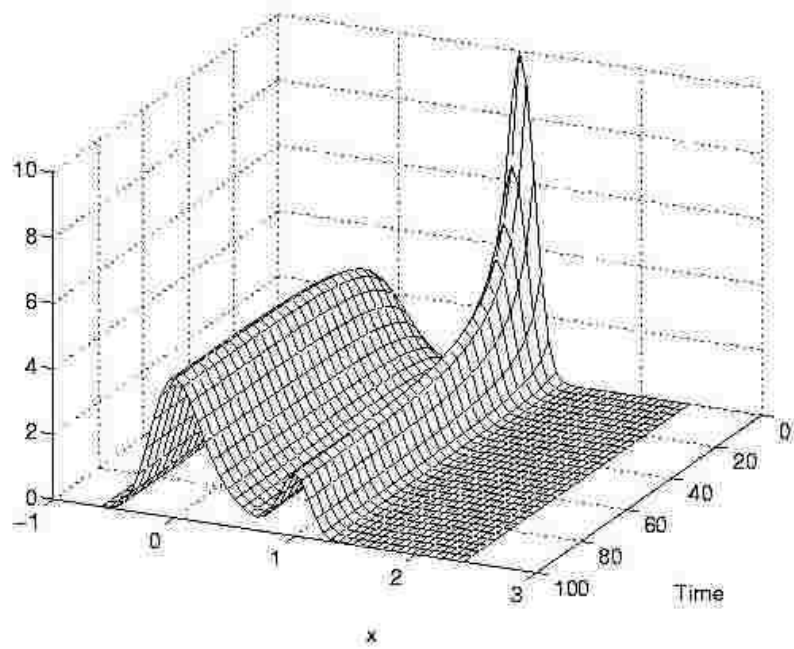
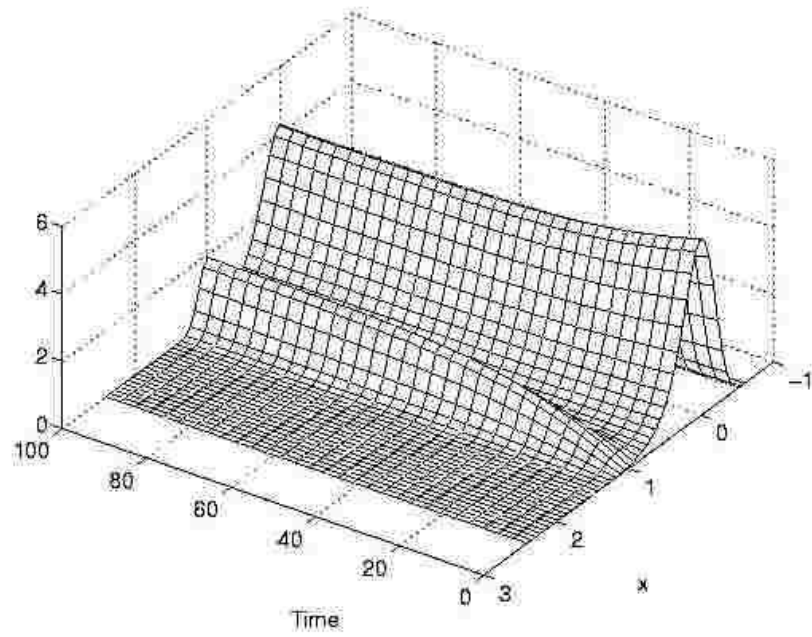
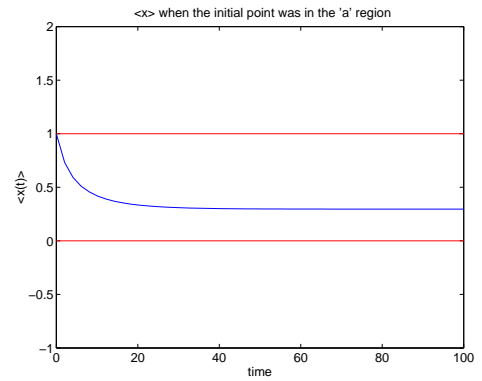
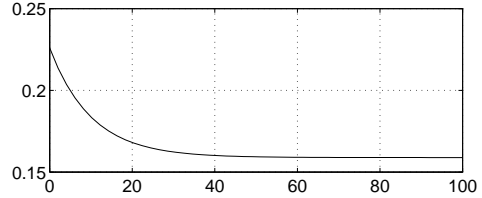
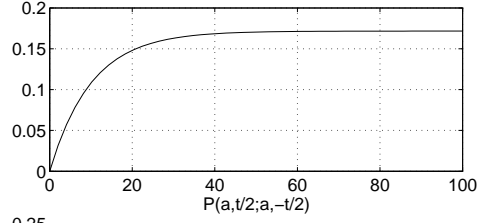
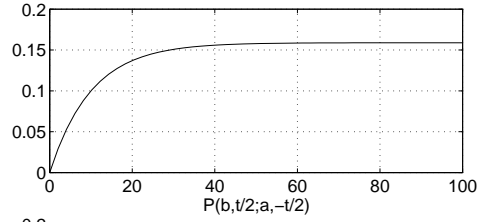
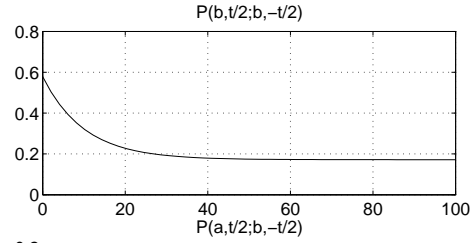
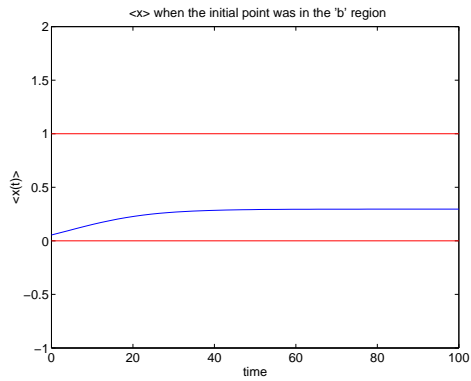
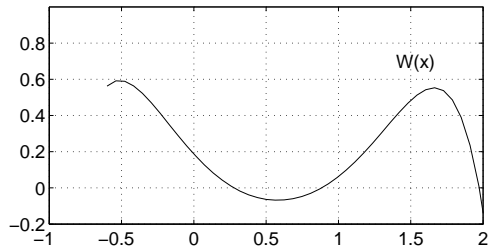
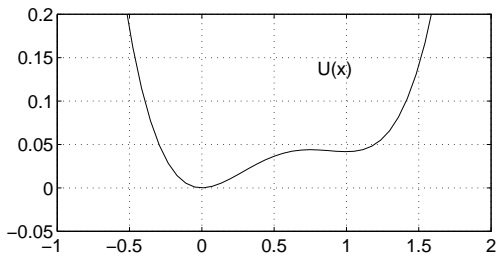
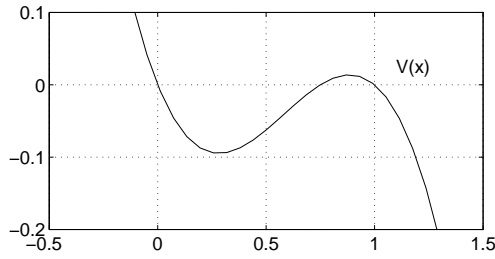

Figure 11: Parameters: $a = 0.75$ and $D = 0.05$



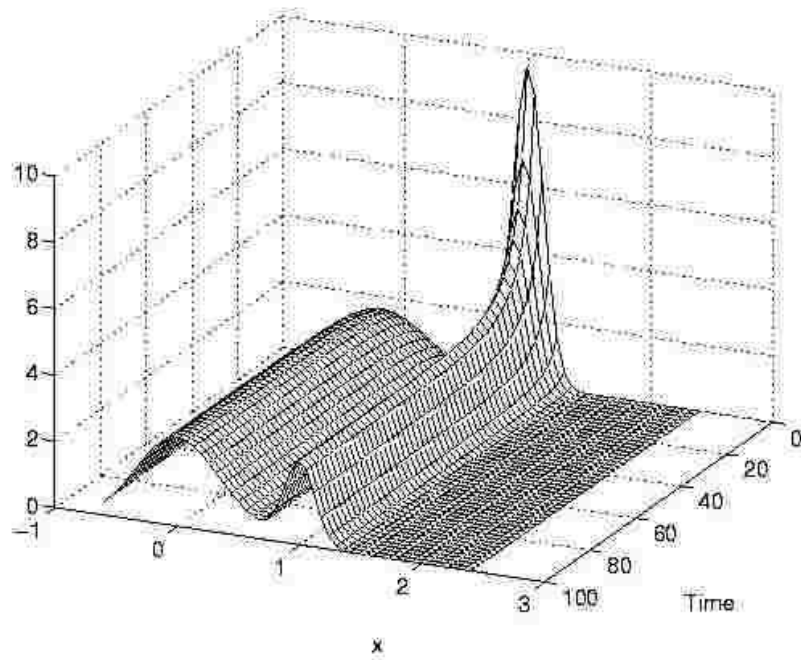
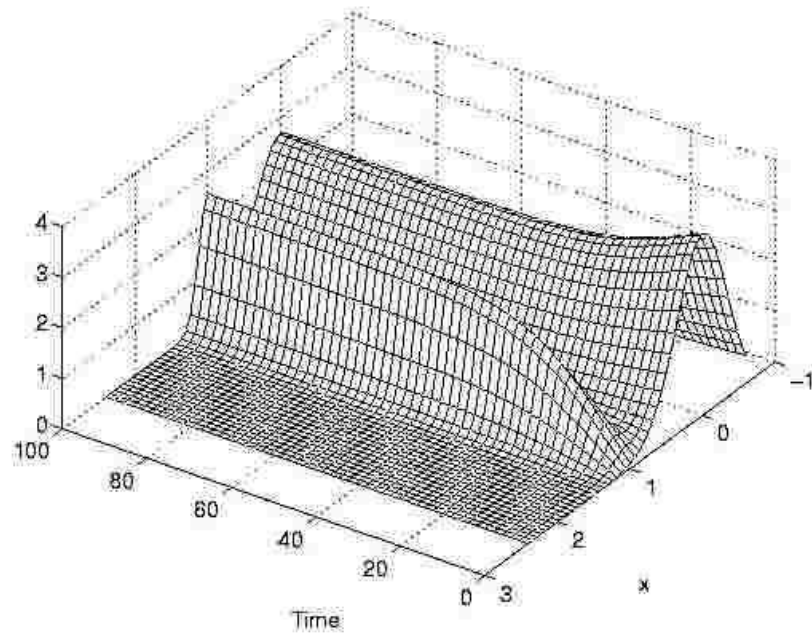
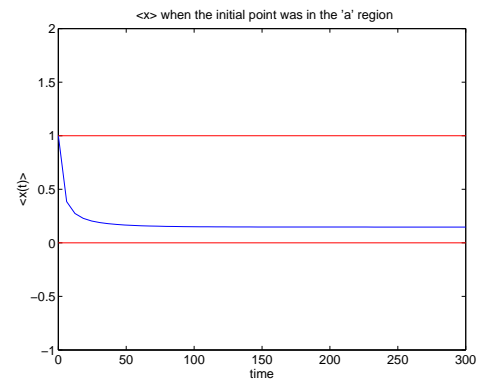
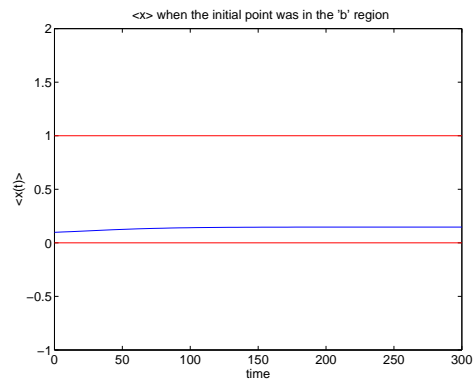
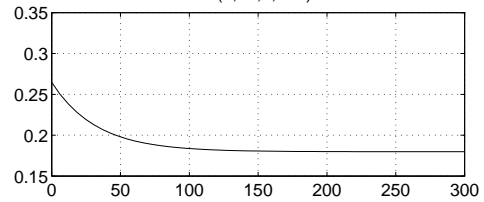
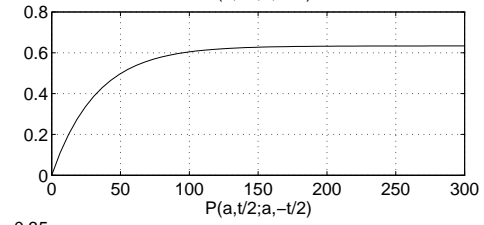
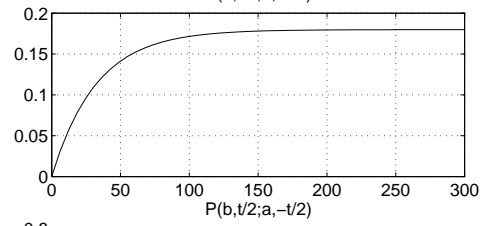
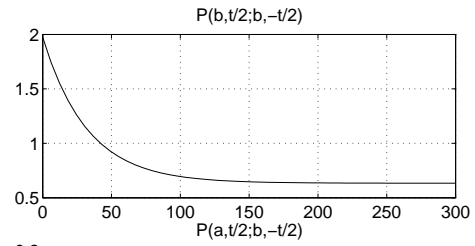
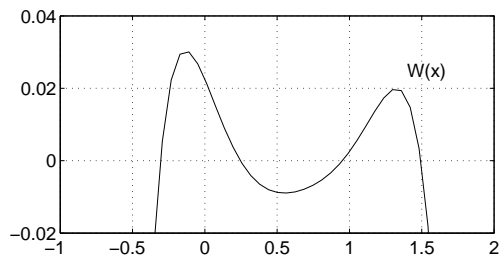
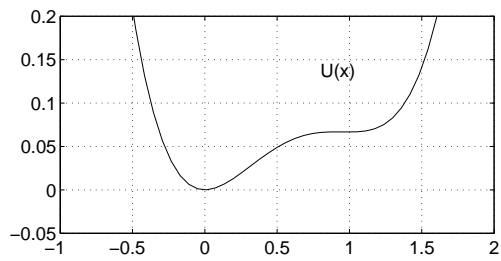
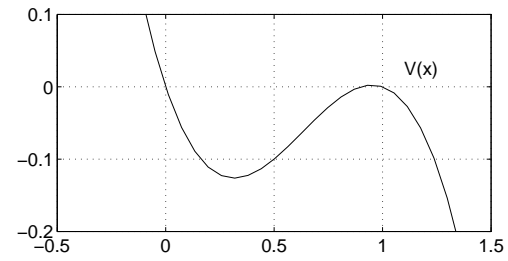

Figure 12: Parameters: $a = 0.75$ and $D = 0.5$



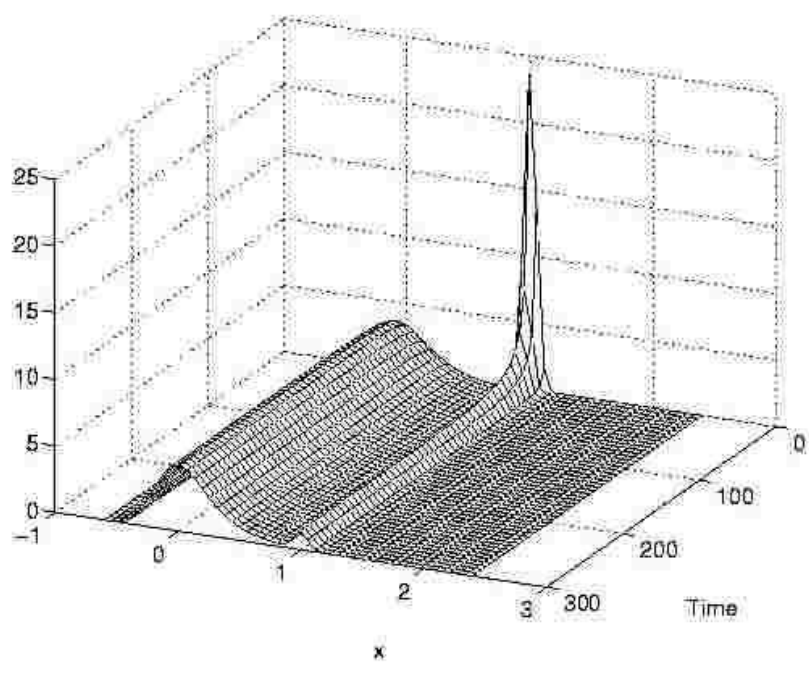
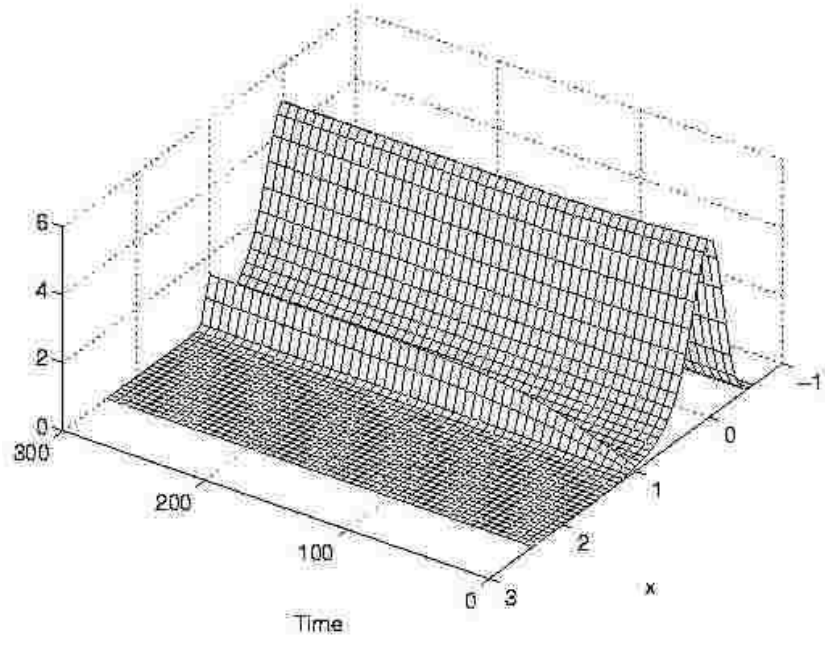

Figure 13: Parameters: $a = 0.9$ and $D = 0.05$

Appendix A : Time variation for general form of the potential

The stochastic motion is described in terms of the *conditional probability* $P(x, t; x_i, 0)$ that the particle initially ($t = 0$) at x_i to be at the point x at time t . We will use the notation that suppress the 0 as the initial time, $P(x, t; x_i)$. The conditional probability obeys the following Fokker-Planck equation

$$\frac{\partial P}{\partial t} = -\frac{\partial}{\partial x} [U'(x) P] + D \frac{\partial^2 P}{\partial x^2}$$

where the velocity function is here derived from the potential U

$$F[x(t), t] \equiv -U'(x)$$

since there is no drive. The initial condition for the probability function is

$$P(x, 0; x_i) = \delta(x - x_i)$$

The simple form of the potential $U(x)$ allows the introduction of two constants

$$\begin{aligned} \omega_0 &\equiv |U''(x=0)| \\ \omega_1 &\equiv U''(x=1) \end{aligned}$$

The following orderings are assumed

$$\begin{aligned} D &\ll \omega_0 \\ D &\ll \omega_1 \end{aligned}$$

The solution of the Fokker-Planck equation is given in terms of the following *path-integral*

$$P(x, t; x_i) = \frac{\exp[-U(x)/2D]}{\exp[-U(x_i)/2D]} K(x, t; x_i)$$

where

$$K(x, t; x_i) = \int D[x(\tau)] \exp\left[-\frac{S}{D}\right] \quad (\text{A.1})$$

where the functional integration is done over all trajectories that start at $(x_i, 0)$ and end at (x, t) . The *action functional* is given by

$$S(x, t; x_i) = \int_0^t d\tau \left[\frac{1}{4} \dot{x}^2 + W(x) \right]$$

with the notation

$$W(x) \equiv \frac{1}{4}U'^2(x) - \frac{D}{2}U''(x)$$

In order to calculate explicitly the functional integral we look first for the paths $x(t)$ that extremize the action. They are provided by the Euler-Lagrange equations, which reads

$$\frac{\delta S}{\delta x_c} = -\frac{1}{2}\ddot{x}_c + W'(x_c) = 0$$

with the boundary condition

$$\begin{aligned} x_c(0) &= x_i \\ x_c(t) &= x \end{aligned}$$

The first thing to do after finding the extremizing paths is to calculate the *action* functional along them, S_c . After obtaining these extremum paths we have to consider the contribution to the functional integral of the paths situated in the neighborhood and this is done by expanding the action to second order. The argument of the expansion is the difference between a path from this neighborhood and the extremum path. The functional integration over these differences can be done since it is Gaussian and the result is expressed in terms of the *determinant* of the operator resulting from the second order expansion of S . Then the expression (A.1) becomes

$$K = N \frac{1}{|\det \widehat{L}(x_c)|^{1/2}} \exp\left(-\frac{S_c}{D}\right) \quad (\text{A.2})$$

where

$$\widehat{L}(x_c) \equiv \frac{\delta^2 S}{\delta x(\tau)^2} \Big|_{x(\tau)=x_c(\tau)} = -\frac{1}{2} \frac{d^2}{d\tau^2} + W''(x_c) \quad (\text{A.3})$$

The constant N is for normalization.

In order to find the determinant, one has to solve the eigenvalue problem

$$\left[\widehat{L}(x_c) - \lambda_n\right] \phi_n(\tau) = 0 \quad (\text{A.4})$$

with boundary conditions for the *differences* between the trajectories in the neighborhood and the extremum trajectory

$$\phi_n(0) = \phi_n(t) = 0$$

It can be shown that

$$\frac{N^2}{\left| \det \widehat{L}(x_c) \right|} = \frac{1}{2\pi D \dot{x}_c(0)} \frac{\partial E}{\partial x}$$

where E is the energy of the path $x_c(\tau)$. (see **Dashen and Patrascioiu**).

There is a fundamental problem concerning the use of the equation (A.2). It depends on the possibility that all the eigenvalues from the Eq.(A.4) are determined. However, a path connecting a point in the neighborhood of the maximum of $U(x)$,

$$x_i \sim 0 + O\left(\sqrt{D}\right)$$

with a point in the neighborhood of one of the minima

$$x \sim \pm 1 + O\left(\sqrt{D}\right)$$

is a kinklike solution. This solution (which will be replaced in the expression of the operator in Eq.(A.4) contains a parameter, the “center” of the kink, t_0 . This is an arbitrary parameter since the moment of traversation is arbitrary. The equation for the eigenvalues has therefore a symmetry at time translations of t_0 and has as a consequence the appearance of a *zero* eigenvalue. Then the expression of the determinant would be infinite and the rate of transfer would vanish. Actually, the time translation invariance is treated by considering the arbitrary moment t_0 as a new variable and performing a change of variable, from the set of functions ϕ_n to the set $(t_0, \phi_{n, n \neq 0})$. The trajectory that extremizes the action is a kinklike solution $\bar{x}(\tau, t_0)$ (is not exactly a kink since the shape of the potential is not that which produces the tanh solution) connecting the points :

$$\begin{aligned} \bar{x}(0, t_0) &= x_i \\ \bar{x}(t, t_0) &= x \end{aligned}$$

This treatment then consists of considering t_0 as a collective coordinate (see **Rajaraman and Coleman and Gervais & Sakita**). The new form of Eq.(A.2) is

$$K = N \int_0^t dt_0 J \frac{\exp(-\bar{S}/D)}{\left| \det' \widehat{L}(\bar{x}) \right|^{1/2}} \quad (\text{A.5})$$

where \bar{S} is the action of the path $\bar{x}(\tau, t_0)$. The fact that the zero eigenvalue has been eliminated is indicated by the '.

The factor in the integral is approximately

$$J^2 = \frac{1}{2\pi D} [U(x_i) - U(x)]$$

Two limits of time are important. The first is

$$t_s = \frac{1}{2\omega_0} \ln\left(\frac{\omega_0}{D}\right)$$

For the times

$$0 \leq t \lesssim t_s$$

for a particle initially in the region of the *unstable* state, $x_i \sim O(\sqrt{D})$, the region around the *stable* state, ± 1 , or: $x \sim \pm 1 + O(\sqrt{D})$ is insignificant for the calculation of the probability $P(x, t; x_i)$. Then the expression (A.2) can be used.

Much more important is the subsequent time regime

$$t > t_s$$

where the particles leave the *unstable* point and the equilibrium state with density around the *stable* positions ± 1 is approached. Then the general formula (A.5) should be used.

The expression of the potential in general does not allow an explicit determination of the extremizing trajectories. Approximations are necessary.

The energy E of the path $x_c(\tau)$ connecting the points $(x_i = 0, 0)$ and (x, t) can be approximated from the expression (see **Caroli**)

$$t = \int_0^x dx' \frac{1}{[2(W_0(x') + E)]^{1/2}} - \Theta_0(x, 0)$$

where

$$\Theta_0(z, y) = \int_y^z dx' \left(\frac{1}{|U'_0(x')|} - \frac{1}{|U'(x')|} \right)$$

The notations are

$$W_0 = \frac{1}{4}U_0'^2 - \frac{D}{2}U_0''$$

$$U'_0(x) = -\omega_0 x$$

The last expressions are the harmonic approximation of V_0 and the potential around the *unstable* point $x = 0$.

The additional term $\Theta(x, 0)$ is the amount of time accounting for the deviation of V from the parabolic profile, the anharmonic deviation $V - V_0$. The result for this simpler case is

$$P(x, t; 0, 0) = \frac{\omega_0}{\sqrt{\pi}} \frac{1}{|U'(x)|} \sqrt{G} \exp(-G)$$

where

$$G = \frac{\omega_0}{D} \frac{x^2}{\exp[2\omega_0 T_0(x)] - 1}$$

$$T_0(x) \equiv t + \Theta_0(x, 0)$$

Two time regimes are interesting. First, the very short time, less than the period of the particle in the potential,

$$0 \leq t \lesssim \frac{1}{2\omega_0}$$

the result reduces to the harmonic problem around $x = 0$.

For longer times,

$$\frac{1}{2\omega_0} \ll t \lesssim t_s$$

the result is

$$P(x, t; 0, 0) = \frac{1}{\sqrt{\pi}} F' \exp(-F^2)$$

where

$$F = \left(\frac{\omega_0}{D}\right)^{1/2} x \exp[-\omega_0 T_0(x)]$$

This is the scaling solution of Suzuki.

The general expression of the function K in the case where we include the time regimes beyond the limits given above. It has the form of a convolution

$$K = \int_0^t dt_0 \bar{x}_0(t_0) K(x, t_1; x_m) K(x_m, t_0; x_i)$$

Here the approximations for the ratio $N / [\det \widehat{L}(x_c)]^{1/2}$ are obtained by the same method as before. The relation between the energy and the time is used for the two main regions: around the *stable* and the *unstable* (initial) positions

$$t_0 = \int_{x_i}^{x_m} dx' \frac{1}{[2(W_0 + E_0)]^{1/2}} - \Theta_0(x_m, x_i)$$

$$t_1 = \int_{x_m}^x dx' \frac{1}{[2(W_1 + E_1)]^{1/2}} - \Theta_1(x, x_m)$$

References

- [1] S.-I. Itoh, K. Itoh, M. Yagi, M. Kawasaki and A. Kitazawa: *Physics of Plasmas* **9** (2002) 1947.
- [2] S.-I. Itoh, A. Kitazawa, M. Yagi and K. Itoh: *Plasma Phys. Control. Fusion* **44** (2002) 1311.
- [3] S.-I. Itoh and K. Itoh: *Plasma Phys. Control. Fusion* **43** (2001) 1055.
- [4] S.-I. Itoh and K. Itoh: *J. Phys. Soc. Japan* **68** (1999) 1891.
- [5] S.-I. Itoh and K. Itoh: *J. Phys. Soc. Japan* **68** (1999) 2611.
- [6] S.-I. Itoh and K. Itoh: *J. Phys. Soc. Japan* **69** (2000) 408.
- [7] S.-I. Itoh and K. Itoh: *J. Phys. Soc. Japan* **69** (2000) 427.
- [8] S.-I. Itoh and K. Itoh: *J. Phys. Soc. Japan* **69** (2000) 3253.
- [9] K. Itoh, S.-I. Itoh, F. Spineanu, M.O. Vlad and M. Kawasaki: *Plasma Phys. Control. Fusion* **45** (2003) 1.
- [10] P. H. Rebut and M. Hugon: in *Plasma Physics and Controlled Nuclear Fusion Research* 1984 (IAEA, 1985, Vienna) Vol.2, 197.
- [11] B. D. Scott: *Phys. Fluids* **B4** (1992) 2468.
- [12] J. F. Drake, A. Zeiler and D. Biskamp: *Phys. Rev. Lett.* **75** (1995) 4222.
- [13] D. Biskamp and A. Zeiler: *Phys. Rev. Lett.* **74** (1995) 706.
- [14] D. Biskamp and M. Walter: *Phys. Lett.* **109A** (1985) 34.
- [15] R. E. Waltz: *Phys. Rev. Lett.* **55** (1982) 1098.
- [16] B. A. Carreras *et al.*: *Phys. Fluids* **B4** (1992) 3115.
- [17] H. Nordman, V. P. Pavlenko and J. Weiland: *Phys. Plasmas* **B5** (1993) 402.
- [18] K. Itoh, S.-I. Itoh, A. Fukuyama, M. Yagi and M. Azumi: *Plasma Phys. Contr. Fusion* **36** (1994) 279.
- [19] K. Itoh *et al.* *J. Phys. Soc. Jpn.* **65** (1996) 2749.

- [20] M. Yagi, S. -I. Itoh, K. Itoh, A. Fukuyama and M. Azumi: *Phys. Plasmas* **2** (1995) 4140.
- [21] J. D. Callen *et al.* : in *Plasma Physics and Controlled Nuclear Fusion Research* (IAEA, Vienna, 1986) Vol.2, 157.
- [22] A. I. Smolyakov: *Plasma Phys. Contr. Fusion* **35** (1993) 657.
- [23] Z. Chang *et al.*: *Phys. Rev. Lett.* **74** (1995) 4663.
- [24] S. -I. Itoh and K. Itoh: *Phys. Rev. Lett.* **60** (1988) 2276.
- [25] K. C. Shaing *et al.*: in *Plasma Physics and Controlled Nuclear Fusion Research* 1988 (IAEA, 1989, Vienna) Vol. 2, 13.
- [26] A. Yoshizawa, S. -I. Itoh and K. Itoh: *Plasma and Fluid Turbulence* (IOP, England, 2002).
- [27] P. Hänggi, P. Talkner and M. Borcovec: *Rev. Mod. Phys.* **62** (1990) 251.
- [28] H. Risken: *The Fokker-Planck equation*, 2nd. ed. (Springer, Berlin, 1989).
- [29] J. S. Langer: *Ann. Phys. (N.Y.)* **41** (1967) 108.
- [30] R. P. Feynman and A. R. Hibbs: *Quantum Mechanics and Path Integrals* (McGraw-Hill, New York, 1965).
- [31] B. Caroli, C. Caroli and B. Roulet: *J. Statistical Mech.* **26** (1981) 83.
- [32] U. Weiss and W. Haeffner: *Phys. Rev.* **D27** (1983) 2916.
- [33] U. Weiss, H. Grabert, P. Hänggi and P. Riseborough: *Phys. Rev* **B35** (1987) 9535.
- [34] U. Weiss: *Phys. Rev.* **A25** (1982) 2444.
- [35] W. T. Coffey, D. S. F. Crothers and Yu. P. Kalmykov: *Phys. Rev.* **E55** (1997) 4812.
- [36] P. C. Martin, E. D. Siggia and H. A. Rose: *Phys. Rev.***A8** (1973) 423.
- [37] R. J. Jensen: *J. Statistical Mech.* **25** (1981) 183.
- [38] G. B. Crew and T. Chang: *Phys. Fluids* **31** (1988) 3425.

- [39] F. Spineanu, M. Vlad and J. H. Misguich: *J. Plasma Physics* **51** (1994) 113.
- [40] F. Spineanu and M. Vlad: *J. Plasma Physics* **54** (1995) 333.
- [41] C. De Dominicis and L. Peliti: *Phys. Rev.* **B18** (1978) 353.
- [42] P. F. Byrd and M. D. Friedman: *Handbook of elliptic integrals for engineers and scientists*, 2nd ed. (Springer, New York, 1971)
- [43] D. Waxman and A. J. Leggett, *Phys. Rev.* **B32** (1985) 4450.
- [44] D. W. McLaughlin: *J. Math. Phys.* **13** (1972) 1099.