

Induced Absorption Resonance on the Open $F_g = 1 \rightarrow F_e = 2$ Transition of the D_1 Line of the ^{87}Rb Atom

A.S.Zibrov^{a,b} and A.B.Matsko^c

^a Lebedev Physical Institute, Russian Academy of Sciences, Leninsky pr. 53, Moscow, 117924, Russia,

^b Department of Physics, Harvard University, Cambridge, Massachusetts, 02138, USA,

e-mail: azibrov@cfa.harvard.edu

^c Jet Propulsion Laboratory, California Institute of Technology, 4800 Oak Grove Drive, Pasadena, California, 91109-8099, USA

Submitted 1 August 2005

Induced absorption resonance on the open $F_g = 1 \rightarrow F_e = 2$ transition of the D_1 line of the ^{87}Rb atom has been observed. The effect of atomic motion on the formation of the resonance has been revealed. The numerical calculations are in good agreement with experiment.

PACS: 42.50.Gy, 42.65.k

Narrow atomic resonances are always important in spectroscopy, particularly in metrology. A new type of resonances was recently discovered in a degenerate two-level system and was called induced absorption resonance [1]. Rautian [2] pointed out that spontaneous coherence transfer plays an important and universal role in the formation of spectra. If transitions with approximately equal frequencies $\nu_{m_1-n_1}$ and ν_{m-n} , where m_i and n_i are the upper and lower levels, respectively, are coupled through spontaneous relaxation, it transfers coherence between the states $|m_i\rangle$ and $|n_i\rangle$. Rautian considers that the importance of this process is comparable with the importance of the spontaneous and stimulated emission processes introduced by Einstein. In the spectroscopy of a coherently prepared medium, coherence spontaneous transfer is clearly manifested when induced absorption resonance is observed. Its name appeared by analogy with induced transparency resonance. In the case of induced absorption resonance, absorption increases due to constructive interference between the quantum states of the system. Coherence is transferred between Zeeman sublevels due to a spontaneous process [3, 4]. As was recently predicted in [5], spontaneous coherence transfer could be efficiently used in the γ radiation range to control Mossbauer spectra. Analysis of spontaneous coherence transfer seems to be important, because this effect is the same in microwave and optical ranges, as well as in γ optics. This motivation stimulated us to study induced absorption resonance in the rubidium vapor and to present the results in this paper.

Induced absorption resonance was first detected on the closed transition of the D_2 line of the Rb atom that absorbs two in-phase copropagating light waves [1]. It was pointed out that induced absorption resonance was

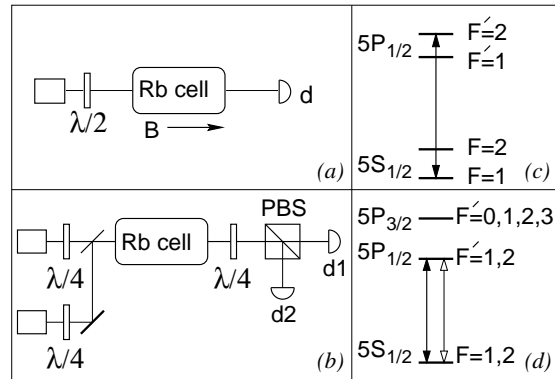

Fig.1: Layouts of the experiments and the scheme of levels for observing induced absorption resonance. (a) The Hanle configuration experiment, where the transmittance of the linearly polarized coherent light is detected as a function of the magnetic field B . (b) The experiment that involves a pump laser inducing atomic coherence and the probe laser. The transmission of a weak circularly polarized probe field is measured as a function of the frequency. The frequency of the pump laser is fixed. The rotation of the polarization of the pump field is opposite to the rotation of the polarization of the probe field. (c) The scheme of the levels of the D_1 line of the ^{87}Rb atom. (d) The scheme of the levels of the D_1 and D_2 lines of the ^{87}Rb atom.

observed when the degeneracy factor of the excited state exceeded the degeneracy factor of the ground state, i.e., $0 < F_g \leq F_e = F_g + 1$ [6]. This effect was theoretically described in [7] for various intensities of the pump field, magnetic moments, and polarizations.

Signals associated with induced absorption resonance were also observed in experiment [8], where the Hanle configuration was used (laser light propagated along the magnetic-field direction). In that experiment,

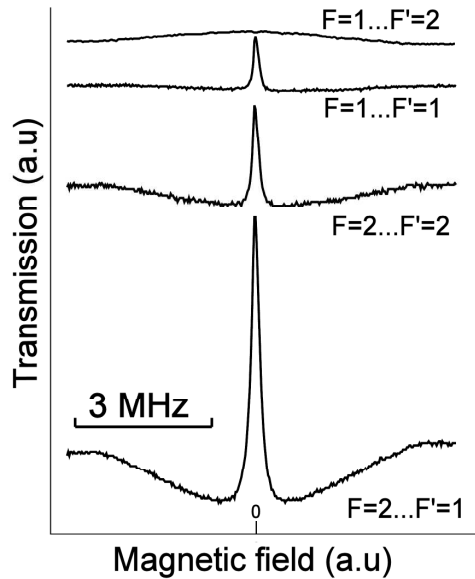

Fig.2: Transmission of laser radiation vs. the longitudinal field magnitude (see the layout in Fig. 1a). The laser frequency is tuned to the D_1 line of the ^{87}Rb atom. Transmission increases at zero magnetic field for all the transitions except for the $F = 1 \rightarrow F' = 2$ transition (see Fig. 1c). The relative amplitudes of the resonances are not changed. The magnitude of the induced absorption resonance on the $F = 1 \rightarrow F' = 2$ transition is very small and is equal to 0.2% of the total 60% absorption. The shape of the resonance is shown in Fig. 3.

the atomic Rb vapor was pumped by a single linearly polarized wave. In the case of the degeneracy of the lower level of the ground state, bright resonances were detected in fluorescence with a concomitant increase in absorption. Those experimental results were theoretically analyzed in [9]. In the more recent work [10], it was shown that an increase in absorption in the Hanle configuration should also be expected when a laser beam is perpendicular to the magnetic field.

As was mentioned above, induced absorption resonance was observed on the closed transition of the degenerate ground state. The weak induced absorption resonance was also observed on the open $F_g = 2 \rightarrow F_e = 2, 3$ transition in the ^{85}Rb atom [8]. However, on the other open transition $F_g = 1 \rightarrow F_e = 2$ of the D_1 line of the ^{87}Rb atom, the effect was not detected [11, 12]. It was assumed that this was due to optical pumping and the low degeneracy factor of the corresponding atomic states.

In this paper, we present the results of the experimental investigation of induced absorption resonance on the open $F_g = 1 \rightarrow F_e = 2$ transition of the D_1 line scheme [1] and in the Hanle configuration [8]. The

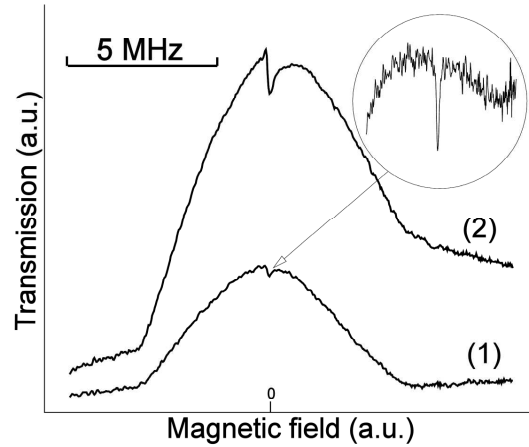

Fig.3: Transmission of laser radiation vs. the magnetic field B in the experiment whose layout is shown in Fig. 1a. The laser is tuned to the open $F = 1 \rightarrow F' = 2$ transition (of the D_1 line). Transmission increases at zero magnetic field. Lines 1 and 2 correspond to the laser-field intensities 1.5 and 3 mW/cm^2 , respectively. A decrease in absorption on line 1 is equal to 3% of the total 60% absorption. The inset shows the fine structures of induced absorption resonance.

observed effect appeared to be weak (0.2% of the total absorption due to the optical-pumping-induced depletion of the population). Optical pumping does not completely destroy spontaneous coherence transfer, which is responsible for the formation of induced absorption resonance, because the atoms interact with light for a finite time. Thus, this experiment corroborates that induced absorption resonance occurs on all $F_g \rightarrow F_e = F_g + 1$ transitions both closed and open. The numerical calculation confirms the conclusions drawn using those experimental results.

We describe both experiments. The first experiment is the same as in [11]. Figure 1a shows the layout of the setup. An external-cavity laser was tuned to the D_1 or D_2 line of the ^{87}Rb atom (see Figs. 1c,1d). A laser beam passed through a half-wave plate and a cell 3.0 cm in length that contained isotopically pure ^{87}Rb . The vapor density was controlled by the cell temperature. The transmission was detected by a photodiode d . The cell was placed in a three-layer magnetic screen. The longitudinal magnetic field is produced by a solenoid placed inside the screen. The static magnetic field gives rise to the appearance of Zeeman sublevels. The splitting was equal to the splitting $\mu_B B/\hbar$ between the neighboring Zeeman sublevels, where μ_B is the Bohr magneton. In the case of the ^{87}Rb atom, the splitting is equal to $B \times 0.7 \text{ MHz}/G$.

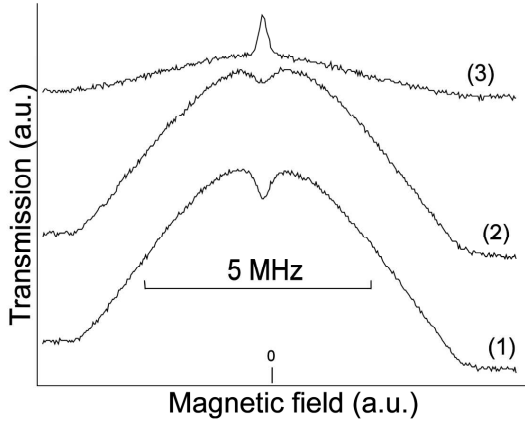

Fig.4: Transmission of laser radiation vs. the magnetic field B in the experiment whose layout is shown in Fig. 1a (Hanle configuration). The laser is tuned near the transition $5S_{1/2}, F = 1 \rightarrow 5P_{3/2}, F' = 0, 1, 2$ of the D_2 line of the rubidium atom: (1) the laser frequency is shifted by 250 MHz from the center of the Doppler profile toward the blue end, (2) the laser frequency is turned to the center of the Doppler profile, and (3) the laser frequency is shifted by 250 MHz from the center of the Doppler profile toward the red end. A decrease of absorption at the center of line 1 is equal to 2%, whereas the total absorption is equal to about 60%.

In the second experiment, two external-cavity lasers were used. The frequency of the laser creating coherence remained unchanged, whereas the frequency of the probe laser was scanned. The radiation of the strong laser after the passage through a quarter-wave plate became circularly polarized in the direction σ^+ , whereas the radiation of the probe laser was polarized in the opposite direction σ^- . Downstream of the cell, beams were split by a quarter-wave plate and polarization cube (PBS) and were detected by photodetectors $d1$ and $d2$.

The magnetic-field dependence of the light transmission at four frequencies in the Hanle experiment is shown in Fig.2. The cell temperature was equal to 50 C, the light power was 0.1 mW, and the beam diameter was equal to 1.5 mm. The transmission increases near the region where the magnetic field is zero for all transitions except for the $F = 1 \rightarrow F' = 2$ transition. The absorption resonance with the subnatural width of the optical transition is almost unseen in the curve. This behavior was observed in [11].

After an increase in sensitivity, we detected this increase in absorption (see Fig. 3). The induced absorption resonance is broadened as the intensity of light increases and disappears at intensities above $20mW/cm^2$

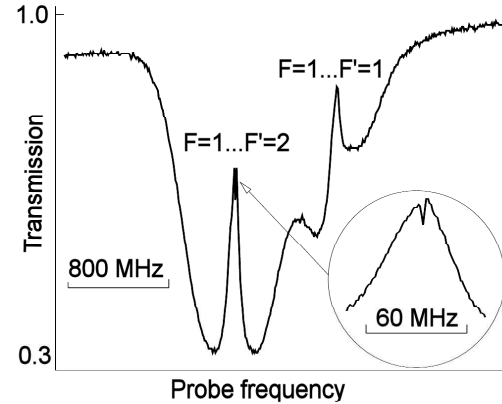

Fig.5: Transmission I_{out}/I_{in} of the probe beam in the experiment whose layout is shown in Fig. 1b. The frequency of the laser inducing coherence is tuned to the open transition $5S_{1/2}, F = 1 \rightarrow 5P_{1/2}, F' = 2$ (see Fig. 1d). The inset shows the resonance peak at an increased scale.

. The total increase in absorption is a consequence of the depopulation of levels due to optical pumping.

An increase in absorption was also observed on the transition $5S_{1/2}; F = 1 \rightarrow 5P_{3/2}; F' = 0, 1, 2$ of the D_2 line of rubidium. Unfortunately, the Doppler broadening prevents the resolution of all the transitions interacting with light in this transition. We measured the transmission for three different tunings of the laser frequency (see Fig. 4). An increase in absorption is easily seen with tuning to the high-frequency part of the Doppler profile. We emphasize that interaction with the $F = 1 \rightarrow F' = 2$ transition is stronger at these frequencies, whereas interaction with the $F = 1 \rightarrow F' = 0$ transition is stronger in the low-frequency range.

Transmission of laser radiation vs. the magnetic field B in the experiment whose layout is shown in Fig. 1a (Hanle configuration). The laser is tuned near the transition $5S_{1/2}, F = 1 \rightarrow 5P_{3/2}, F' = 0, 1, 2$ of the D_2 line of the rubidium atom: (1) the laser frequency is shifted by 250 MHz from the center of the Doppler profile toward the blue end, (2) the laser frequency is tuned to the center of the Doppler profile, and (3) the laser frequency is shifted by 250 MHz from the center of the Doppler profile toward the red end. A decrease of absorption at the center of line 1 is equal to 2%, whereas the total absorption is equal to about 60%.

We studied induced absorption resonance in the standard scheme of experiments with induced absorption, where two lasers were used. The frequency dependence of the transmission of the radiation of the probe laser is shown in Fig. 5. The frequency of the laser cre-

ating coherence was tuned to the center of the Doppler profile of the $F_g = 1 \rightarrow F' = 2$ transition. The power of this laser was equal to 3 mW, whereas the power of the probe laser was equal to 0.1 mW. The beams of both lasers had a diameter of 1.5 mm. Induced absorption resonance was located at the peak of the bell-shaped transparency resonance associated with optical pumping.

In order to explain the experimental results, numerical calculations based on the Maxwell-Bloch equations describing the propagation of the electromagnetic field in the cell are performed with the inclusion of all the Zeeman sublevels of the D_1 line of the ^{87}Rb atom. We studied the interaction with linearly polarized light tuned to the frequency of the $F_g = 1 \rightarrow F_e = 2$ transition of the D_1 line. Light in the model propagates in the direction coinciding with the direction of the external magnetic field. The model also takes into account that atoms are continuously refreshed in the region of interaction with light due to influx from other regions of the cell. The rate γ_0 of this process is determined by the time of flight of atoms through the laser beam. The Bloch equations are the same as in [9]. The calculations were performed with $\gamma_0 = 0.0004\gamma$, where γ is the rate of the natural decay of the excited state, and the Rabi frequency $\Omega = 0.04\gamma$, which corresponds to the field intensity $I_{in} = 0.025\text{mW}/\text{cm}^2$. The normalized magnetic field dependence of the transmission of the incident radiation is shown in Fig. 6. Induced absorption resonance is seen near zero magnetic field. We emphasize that induced absorption resonance on this transition was not observed in the theoretical work [9].

As the intensity of the laser field increases, the contrast of induced absorption resonance decreases. Moreover, we observe in experiments that induced absorption resonance completely disappears at intensities of several milliwatts per centimeter squared. To understand this observation, we performed numerical simulation along the Doppler profile with $\gamma_0 = 0.003\gamma$ and $\Omega = 0.34\gamma$, which corresponds to an intensity of $I_{in} = 1.5\text{mW}/\text{cm}^2$. The width of the velocity distribution was taken to be 100γ . The result of the numerical simulation is shown by the right line in Fig. 6, where it is seen that the behavior of the calculated line coincides with the experimentally observed dependence given by line 1 in Fig. 3.

The resulting differences shown in Figs. 6a and 6b are obviously caused by the motion of atoms. In order to ensure this conclusion, we calculated the population of the $F_e = 2$ excited state for the inhomogeneously broadened transition with various detunings Δ of the laser frequency (in other words, for groups of atoms with var-

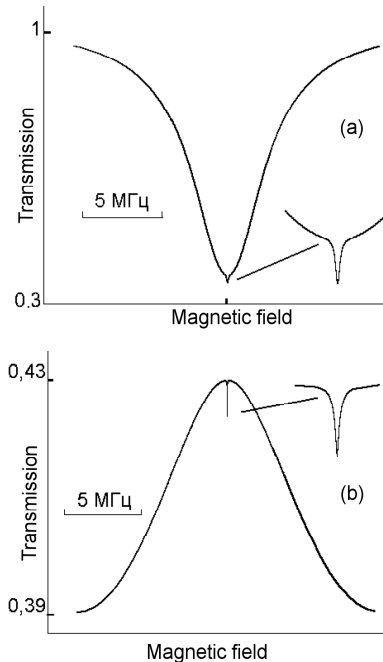

Fig.6: Transmission I_{out}/I_{in} on the open $F = 1 \rightarrow F' = 2$ transition vs. the magnetic field as obtained in the numerical calculation for (a) homogeneously broadened and (b) Doppler broadened rubidium vapor. The calculation was performed for the case shown in Fig. 1a.

ious velocities). The calculations were performed with the same Rabi frequencies and coherence decay rates as in the calculations presented in Fig. 6b and in the experiment (see Fig. 3). As is seen in Fig. 7, induced absorption resonance on the homogeneously broadened transition is not observed at zero detuning and only atoms with nonzero velocity contribute to the formation of the resonance. Such a behavior is due to the fact that atoms with lower velocities more rapidly leave the process of the formation of induced absorption resonance on the inhomogeneously broadened transition. Under the action of optical pumping, atoms efficiently decay into another level of the ground state and thereby the effect of spontaneous coherence transfer, which determines the formation of induced absorption resonance, is small.

Spontaneous coherence transfer is substantial for the $F_g \rightarrow F_e = F_g + 1$ transition, because the population of the magnetic sublevels of the excited state exceeds the population of the sublevels of the states of the $F_g \rightarrow F_e = F_g$ or $F_g \rightarrow F_e = F_g - 1$ transitions under the same conditions. Atoms in these states are trapped in dark states due to coherent population trapping [13],

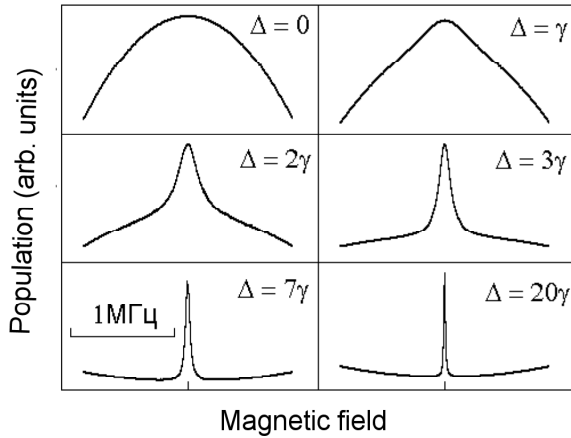

Fig.7: Magnetic-field dependence of the population of the excited state for various detunings Δ for the homogeneously broadened $F = 1 \rightarrow F' = 2$ transition. As the detuning Δ increases, the population decreases. The maximum population at $B = \Delta = 0$ is equal to 0.002. The maximum population for the detuning $\Delta = \gamma, 2\gamma, 3\gamma, 7\gamma,$ and 20γ is equal to 0.98, 0.95, 0.89, 0.59, and 0.15, respectively. The intensity of the laser field and fieldatom interaction are the same as in Fig. 6b. No subnatural width of resonance is observed for atoms with zero velocity.

whereas this is not the case for the $F_g \rightarrow F_e = F_g + 1$ transition.

It is also easy to explain why absorption on the induced absorption resonance near the open transition is small in our experiment. Near the open transition, atoms efficiently decay into another level of the ground state and thereby the effect of spontaneous coherence transfer, which determines the formation of induced absorption resonance, is small.

Thus, induced absorption resonance on the open $F_g = 1 \rightarrow F'_e = 2$ transition of the D_1 line of rubidium has been observed in the experiment. Experiments show that induced absorption resonance is observed even in the presence of strong optical pumping on the transition. Therefore, the previous statement made in [1] that a closed transition is necessary for observing induced absorption resonance should be revised. This study also shows that the intensity range for observing induced absorption resonance in a Doppler broadened medium is wider than that in a homogeneously broadened medium.

In conclusion, we try to explain why the induced absorption resonance on the open transition under investigation was not observed in the previous theoretical and experimental works cited above. The population of the open transition is equal to zero in the steady state. In a real experiment, fresh atoms from other regions of the

cell enter the region of atom-light interaction. This process maintains a nonzero population of the state. The shorter the interaction time, the larger the number of atoms in the excited state. However, when the interaction time is too short, coherence degrades. It is necessary to search for the optimum interaction time. The interaction time is determined by the laser-beam radius. An increase in the radius increases the interaction time. In our experiment, we chose the beam radius according to the available intensities. We think that optimization determined the success in the observation of the induced absorption resonance in this experiment.

We are grateful to V.L. Velichansky and V.P. Yakovlev for interest in this work and stimulating discussions.

1. A. M. Akulshin, S. Barreiro, and A. Lezama, Phys. Rev. A **57**, 2996 (1998).
2. S. G. Rautian, Zh. Eksp. Teor. Fiz. **108**, 1186 (1995) [JETP **81**, 651 (1995)]; Zh. Eksp. Teor. Fiz. **115**, 12 (1999) [JETP **88**, 6 (1999)].
3. A. V. Taichenachev, A. M. Tumaikin, and V. I. Yudin, JETP Lett. **69**, 819 (1999); Phys. Rev. A **61**, 011802 (2000).
4. Among other mechanisms of the formation of the induced absorption resonance, Goren et al. analyzed population transfer between Zeeman sublevels. (C. Goren, A. D. Wilson-Gordon, M. Rosenbluh, and H. Friedmann, Phys. Rev. A **70**, 043814 (2004)).
5. R. Coussement, Y. Rostovtsev, J. Odeurs, et al., Phys. Rev. Lett. **89**, 107601 (2002).
6. A. Lezama, S. Barreiro, and A. M. Akulshin, Phys. Rev. A **59**, 4732 (1999).
7. A. Lipsich, S. Barreiro, A. M. Akulshin, and A. Lezama, Phys. Rev. A **61**, 053803 (2000); A. Lipsich, S. Barreiro, P. Valente, and A. Lezama, Opt. Commun. **190**, 185 (2001).
8. Y. Dancheva, G. Alzetta, S. Cartaleva, et al., Opt. Commun. **178**, 103 (2000).
9. F. Renzoni, C. Zimmermann, P. Verkerk, and E. Arimondo, J. Opt. B: Quantum Semiclass. Opt. **3**, S7 (2001).
10. F. Renzoni, S. Cartaleva, G. Alzetta, and E. Arimondo, Phys. Rev. A **63**, 065401 (2001).
11. F. Renzoni, W. Maichen, L. Windholz, and E. Arimondo, Phys. Rev. A **55**, 3710 (1997).
12. G. Alzetta, S. Cartaleva, Y. Dancheva, et al., J. Opt. B: Quantum Semiclass. Opt. **3**, 181 (2001).
13. E. Arimondo, in *Fundamentals of Quantum Optics III*, Ed. by F. Ehlotz (Springer, Berlin, 1993); Lect. Notes Phys. **420**, 170 (1994); in *Progress in Optics*, Ed. by E. Wolf (Elsevier, Amsterdam, 1996), p. 257.